

PS-508

Description

The PS-508 SO (Saw Oscillator) from Vectron is a high frequency, ultra low phase noise and low g-sensitivity oscillator designed to support harsh environmental applications. The PS-508 provides typical 10fs rms jitter in a 12kHz to 20MHz integration bandwidth and is available from 0.6 to 3GHz.

Features

- Frequency Range 0.6 to 3.0 GHz
- Ultra low jitter and Phase Noise performance
- Typical Jitter: 10fsec rms, 12kHz to 20MHz
- G-Sensitivity <0.6ppb/g
- 3.3 + 5V supply voltage
- Output: Sinewave, balanced Sinewave, LVPECL
- 9x14 mm SMD package
- See table on Page 5 for standard frequencies

Applications

- Harsh Environment
- Military
- Test & Measurement

Performance Specifications

Frequency Stabilities					
Parameter	Min	Typ	Max	Units	Notes
Over All Stability			±200	ppm	Includes df vs: •Operating temperature range -40 .. 85°C •Aging 10 years •Supply Voltage Change 5% •Load change 10% •Initial
Supply Voltage (Vs)					
Supply voltage (standard)	4.75	5.00	5.25	V DC	
Current consumption			65	mA	
Supply voltage (standard)	3.135	3.3	3.465	V DC	
Current consumption			100	mA	

Performance Specifications (Continued)

RF Output					
Parameter	Min	Typ	Max	Units	Notes
Signal	LVPECL				
Load	45	50	55	Ω	
Duty Cycle	45		55	%	
Phase Noise: 100Hz offset		-83		dBc/Hz	@ 1GHz LVPECL 3.3V
Phase Noise: 1kHz offset		-112		dBc/Hz	
Phase Noise: 10kHz offset		-140		dBc/Hz	
Phase Noise: 100kHz offset		-150		dBc/Hz	
Phase Noise: 1MHz offset		-150		dBc/Hz	
Phase Noise: 10MHz offset		-152		dBc/Hz	
Phase Noise: 100MHz offset		-152		dBc/Hz	
Jitter: 12kHz to 20MHz offset		22		fs rms	
Signal	Sinewave				
Load	45	50	55	Ω	
Output Power	0	3	6	dBm	
Phase Noise: 100Hz offset		-83		dBc/Hz	@ 1GHz Sinewave 3.3V
Phase Noise: 1kHz offset		-112		dBc/Hz	
Phase Noise: 10kHz offset		-143		dBc/Hz	
Phase Noise: 100kHz offset		-160		dBc/Hz	
Phase Noise: 1MHz offset		-159		dBc/Hz	
Phase Noise: 10MHz offset		-160		dBc/Hz	
Phase Noise: 100MHz offset		-167		dBc/Hz	
Jitter: 12kHz to 20MHz offset		10		fs rms	

Additional Parameters					
Parameter	Min		Max	Units	Notes
Weight	2.0g				
Subharmonics			-30 -20	dBc dBc	< 2 GHz > 2 GHz
G-Sensitivity		0.6		ppb/g	
Processing and Packing	Handling and Processing Note				
Absolute Maximum Ratings					
Parameter	Min		Max	Units	Notes
Supply Voltage (V_s)			6.0	V	
Operable Temperature Range	-40		+85	$^{\circ}\text{C}$	

Typical Performance

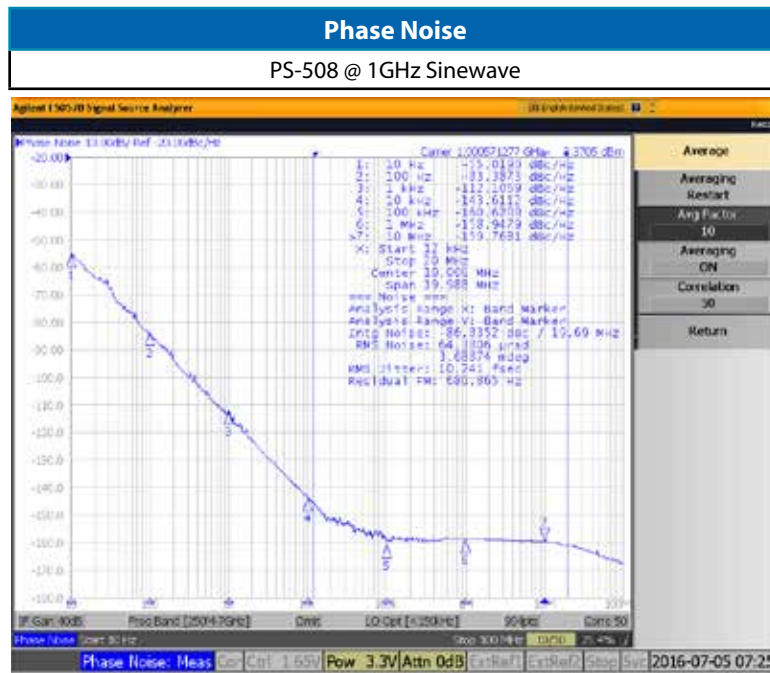

G-Sensitivity

PS-508 @ 1GHz LVPECL

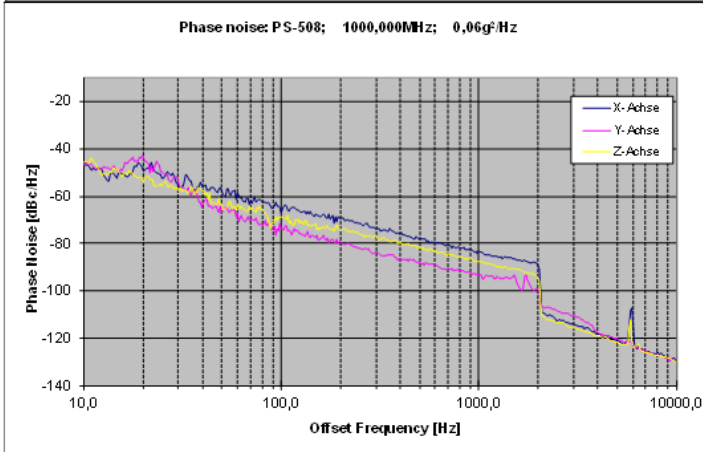
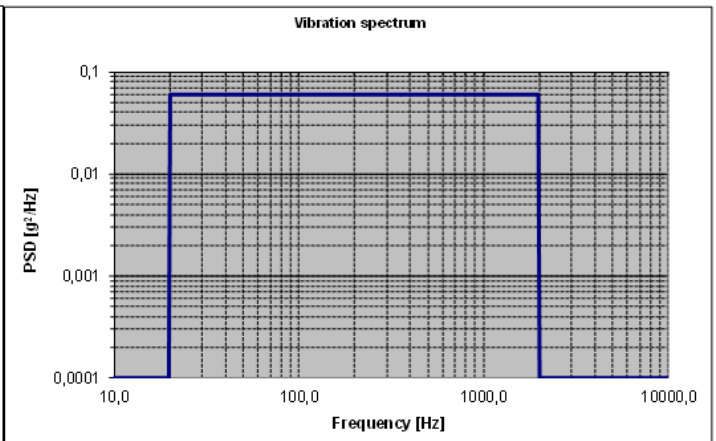
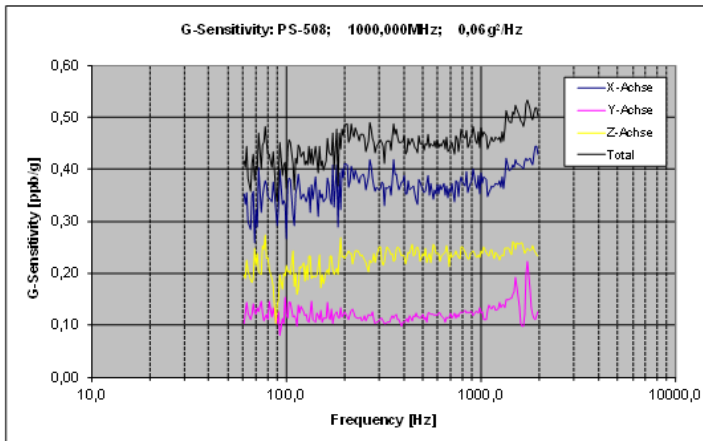

Calculation equation according to Vig-Tutorial

$$g\text{-sensitivity: } G = \frac{2 \cdot f_0}{A_{peak} \cdot f_0} \cdot 10^{\frac{L(f)}{20}}$$

$$\text{Peak-level: } A_{peak} = \sqrt{PSD \cdot 2}$$

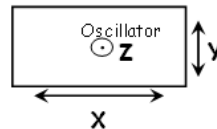

Comments:

Outline Drawing / Enclosure

Package Codes		
Code	Height "H"	Pin Length "L"
G347	4.9	N/A

Dimensions in mm

G347

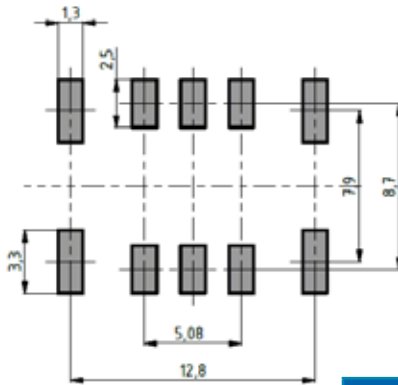
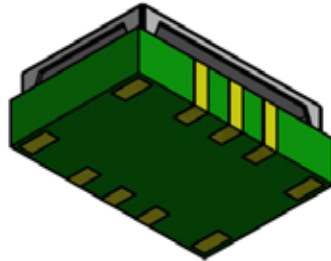
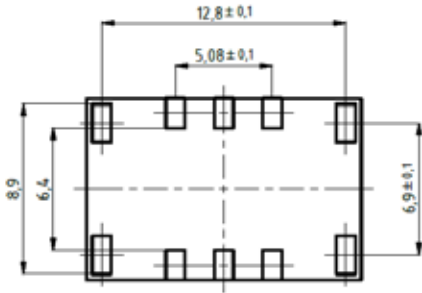

Padvorschlag
land pattern
recommendation

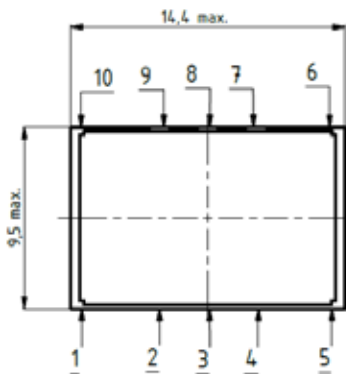

Pin Assignment Sinewave	
1	GND
2	N.C.
3	N.C. (Not Connected)
4	GND
5	GND
6	GND
7	RF Out
8	N.C. (Not Connected)
9	Supply Voltage Input (V_S)
10	GND

Pin Assignment LVPECL	
1	GND
2	N.C.
3	N.C. (Not Connected)
4	GND
5	GND
6	GND
7	RF Out
8	RF-Out_complementary
9	Supply Voltage Input (V_S)
10	GND

Pin Assignment Balanced Sinewave	
1	GND
2	N.C.
3	N.C. (Not Connected)
4	GND
5	GND
6	GND
7	RF Out
8	RF-Out_Compl. 180° phase shifted
9	Supply Voltage Input (V_S)
10	GND

Marking	
PS-508-xxxx	
Frequency	
•AYYWW	

Standard Shipping Method

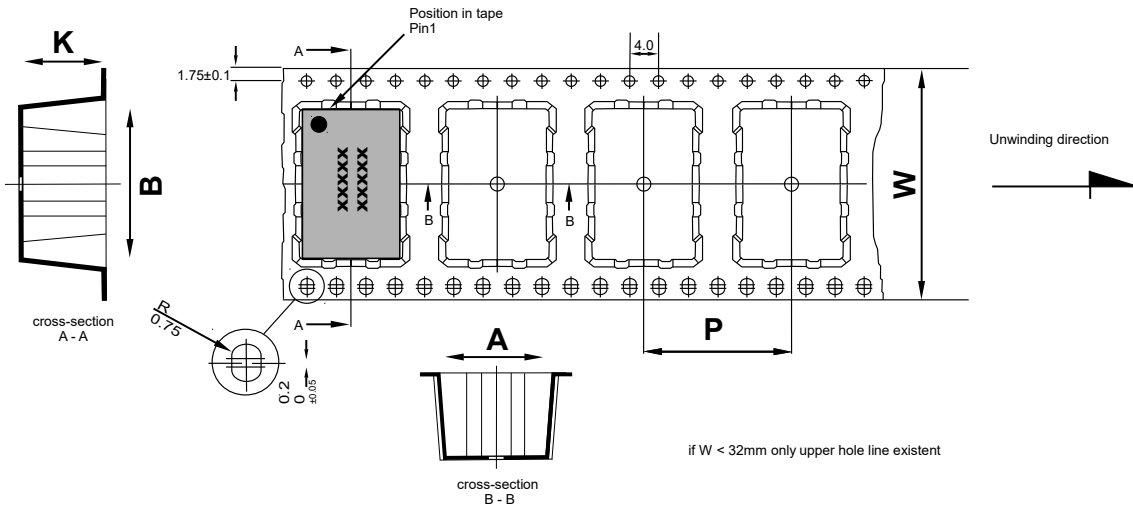

Dimension in mm:

A, B and K are dependent upon component dimensions
production tolerance complying DIN IEC 286-3

All dimensions in millimeters unless otherwise stated

Enclosure Type	Tape Width W (mm)	Quantity per meter	Quantity per reel	Dimension P (mm)
G347	24		850	12

Recommended Reflow Profile

TP: max 250°C (@ solder joint, customer board level)

T_p: max: 10...30 sec

Additional Information:

This SMD oscillator has been designed for pick and place reflow soldering

SMD oscillators must be on the top side of the PCB during the reflow process.

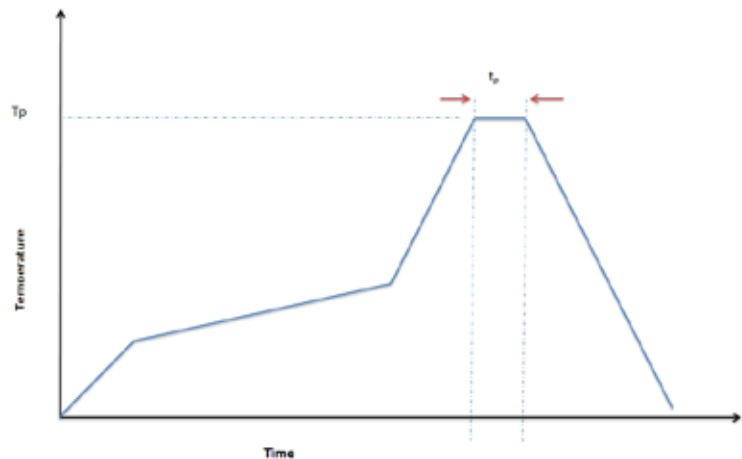

Ordering Information

PS - 508 0 - E E X - 205 X - 2000M0

Product Family
PS: SO

Package
9x14mm SMT

Height
0: 4.9mm (G347)

Supply Voltage
D: +5.0V
E: +3.3V

RF Output Code
C: LVPECL
E: Sinewave
F: Balanced Sinewave

Temperature Range
X: +10°C to +85°C
E: -40°C to +85°C

Stability Code
204: ±200ppm

Frequency
Enable
X: No Enable

Standard Frequencies (MHz)						
632.8125	784.489605	832	867.1875	873.5154185	949.976022	980.604559
993.4096915	1000	1024.23965	1034.337568	1040	1067.686799	1200
1265.625	1280	1568.97921	1687.5	1701.32	1707.08	1734.375
1747.030837	1747.62305	1748.366885	1769.145	1875	1879.437686	1884.052863
1899.952044	1961.209118	1968.75	1986.819383	2000	2048.4793	2068.675135
2104.658326	2135.373597	2187.5	2400	2457.6	2560	2812.5
2949.12						

Other Frequencies Available Upon Request

Notes:

1. Contact factory for improved stabilities or additional product options. Not all options and codes are available at all frequencies.
2. Unless other stated all values are valid after warm-up time and refer to typical conditions for supply voltage, frequency control voltage, load, temperature (25°C).
3. Phase noise degrades with increasing output frequency.
4. Subject to technical modification.
5. Contact factory for availability.



Microsemi Headquarters
One Enterprise, Aliso Viejo, CA 92656 USA
Within the USA: +1 (800) 713-4113
Outside the USA: +1 (949) 386-0100
Sales: +1 (949) 386-0130
Fax: +1 (949) 215-4999
email: sales.support@microsemi.com
www.microsemi.com

Microsemi, a wholly owned subsidiary of Microchip Technology Inc. (NASDAQ: MCHP), offers a comprehensive portfolio of semiconductor and system solutions for aerospace & defense, communications, data centers and industrial markets. Products include high-performance and rad-hard hardened analog microsignal integrated circuits, FPGAs, SoCs and ASICs, power management products, timing and synchronization devices and precision time solutions, setting the world's standard for time, while producing advanced RF solutions, discrete components, oscillators, storage and communication solutions, security technologies and scalable VLSI temper products, Ethernet solutions, Power-over-Ethernet ICs and multiplexers, as well as custom design capabilities and services. Learn more at www.microsemi.com.

Microsemi makes no warranty, representation, or guarantee regarding the information contained herein or the suitability of its products and services for any particular purpose, nor does Microsemi assume any liability whatsoever arising out of the application or use of any product or service. The products and services sold by Microsemi have been subject to limited testing and should not be used in production without extensive testing and qualification. Any performance specifications are intended to be typical and are not guaranteed. And Buyer must contact and consult all performance and other testing of the products, parts and related sets of products to, any and products Buyer must not rely on any data and performance specifications or parameters provided by Microsemi. It is the Buyer's responsibility to independently determine suitability of any products and to test and verify the same. The information provided by Microsemi hereunder is provided "as is, where is" and with all faults, and the user must understand with such information is hereby with it a "Buyer". Microsemi does not give, security or property, to any party any patent rights, licenses, or any other IP rights, whether with regard to such information itself or anything described by such information. Information provided in this document is proprietary to Microsemi, and Microsemi reserves the right to make any changes to the information in this document at its sole discretion and without notice.

©2018 Microsemi, a wholly owned subsidiary of Microchip Technology Inc. All rights reserved. Microsemi and the Microsemi logo are registered trademarks of Microsemi Corporation. All other trademarks and service marks are the property of their respective owners.