

MX-505

Features

- Ultra High Stability MCXO
- Low Power Consumption
- Hermetic Sealed Package
- Meets Stratum 3 acc. GR-1244
- ROHS 6 Compliant
- Frequency Range¹: 8 - 40 MHz
- Standard Frequencies : 10, 12.8, 16.384, 19.2, 20, 22.1184, 24.576, 25 MHz
- Uses Vectron's Ultra Smooth Compensation (USC) Algorithm
- Excellent Phase Noise and Allan Deviation

Applications

- Military
- 1588 Application
- Test Equipment
- Small Cell
- Communication Equipment
- Industrial

Performance Specifications

Frequency Stabilities ^{1,3} (Standard - 8 to 26 MHz)						
Parameter	Min	Typical	Max	Units	Condition ²	Options ³
vs. operating temperature range referenced to (dFmax+dFmin)/2	-30 -20		+30 +20	ppb ppb	-40 to +85°C -20 to +70°C	
In a 24h period at constant temperature	-5		+5	ppb	after 7 days of continuous operation	
Frequency vs. temperature slope		±1.0 ±1.5		ppb/°C ppb/°C	-30 to +80°C, 10 & 20MHz -40 to +85°C, 10 & 20MHz	
Initial tolerance	-0.5		+0.5	ppm	V _s ±5% static Load ±10% static after 30 days of operation after 30 days of operation	
vs. supply voltage change	-10		+10	ppb		
vs. load change	-10		+10	ppb		
vs. aging / 1. year	-0.8		+0.8	ppm		
vs. aging / 10 years	-2.5		+2.5	ppm		

Performance Specifications

Supply Voltage (V _s)					
Parameter	Min	Typical	Max	Units	Condition ²
Supply Voltage (standard)	3.135	3.3	3.465	V	8 - 40MHz
Current Consumption			12	mA	
RF Output					
Signal [standard]	HCMOS				
Load		15		pF	
Signal Level (Vol)			0.3	V	V _s = 3.3V
Signal Level (Voh)	3			V	V _s = 3.3V
Duty Cycle	45		55	%	@ V _s /2
Rise and Fall time			5	ns	10 to 90 %
Frequency Tuning (EFC) 8 to 40					
Tuning Range	Fixed frequency; No adjust				Option ³
Tuning Range	±3.5		+10	ppm	
Linearity			2	%	10 & 20MHz
Tuning Slope	Positive				
Control Input Impedance	20			kOhm	
Control Voltage (V _c) Range	0.0	1.65	3.3	V	
Additional Parameters					
Phase Noise ⁴		-65		dBc/Hz	1 Hz
		-93		dBc/Hz	10 Hz
		-118		dBc/Hz	100 Hz
		-140		dBc/Hz	1 kHz
		-154		dBc/Hz	10 kHz
		-156		dBc/Hz	100 kHz
Jitter		0.2		ps RMS	@ 10 kHz to 5 MHz
ADEV			80	E-12	@ 1sec.
			80	E-12	@10sec
Weight			10.0	g	
Absolute Maximum Ratings					
Supply Voltage (V _s)	-0.6		6.0	V	
Output Load			50	pF	
Operable Temperature Range	-40		+85	°C	
Storage Temperature Range	-40		+90	°C	
Environmental Conditions					
Rapid Temperature Changes	MIL-883-1010 Cond B 500 cycles -55/125C				
Vibration	MIL-STD-883 Meth 2007 Cond A 20G 20-2000Hz 4x in each 3axis 4 min				
Shock	MIL-STD-202 Meth 213B Cond. F; 1500g 0,5ms 6 shocks in each direction				
Solderability	J_STD_002C Cond A, Through hole device/ Cond. B, SMD 255C (diving time 50,5sec.) Dip+Look with 8h damp pre-treatment: solder wetting >95%				
Solvent Resistance	MIL-STD-883 Meth 2015 Solv. 1,3,4				
ESD	JESD22-A114F Class 1B; 10* 2000V				
Moisture Sensitivity	Level 1 JESD22-A113-B				
RoHS Compliance	100% ROHS Compliant				

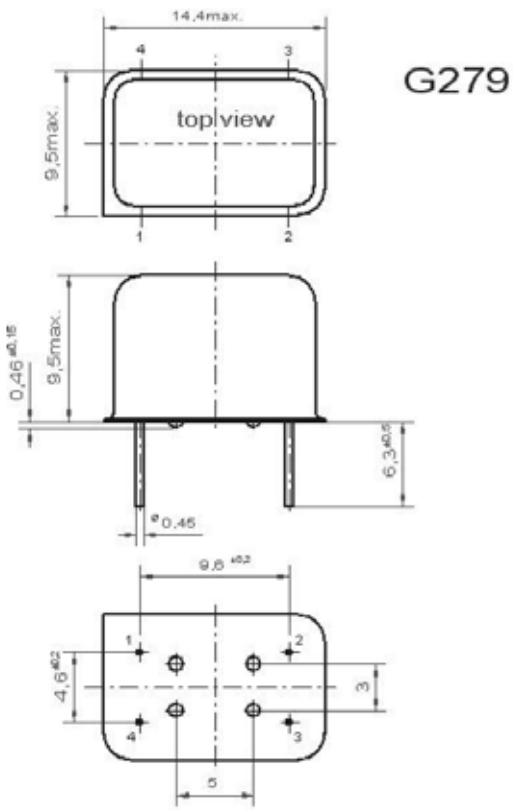

MX-505 / G279	
Height "H"	Pin Length "L"
9.5	6.3

Pin Connections	
1	Control Voltage Input (Vc) / N.C.
2	Ground (Case)
3	RF-Output
4	Supply Voltage Input (Vs)

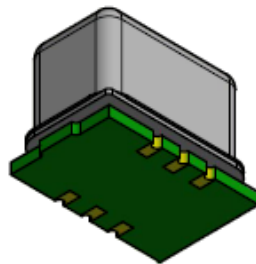
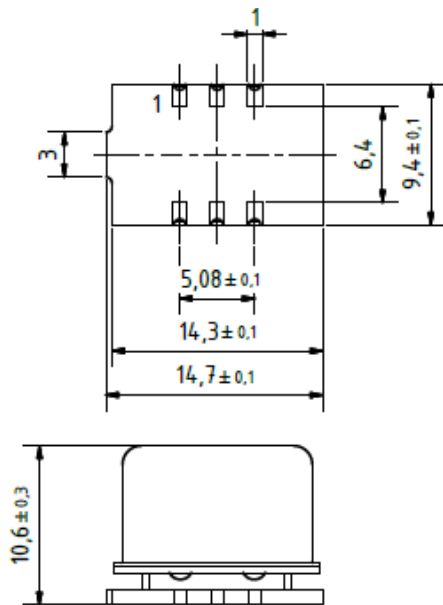

MX-505 / G355	
Height "H"	Pin Length "L"
10.6	N/A

Pin Connections	
1	Control Voltage Input (Vc) / N.C.
2	N.C.
3	Ground (Case)
4	RF-Output
5	N.C.
6	Supply Voltage Input (Vs)

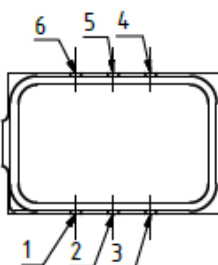

Dimensions in mm

Performance Data

TDEV-without filter



ADEV

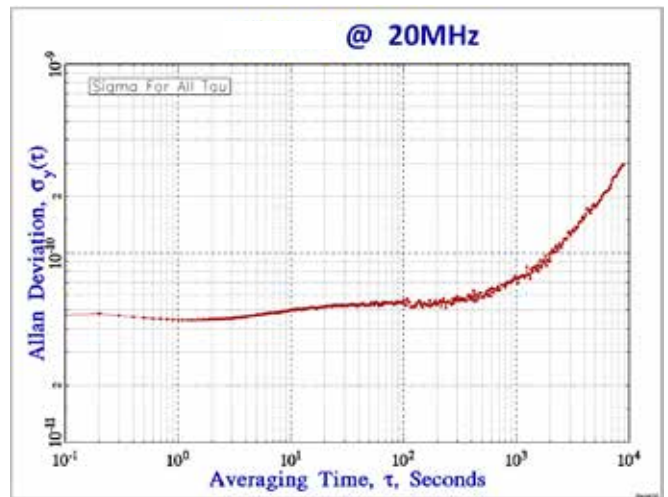

Temperature Stability

Frequency vs. Temperature
@ 20MHz

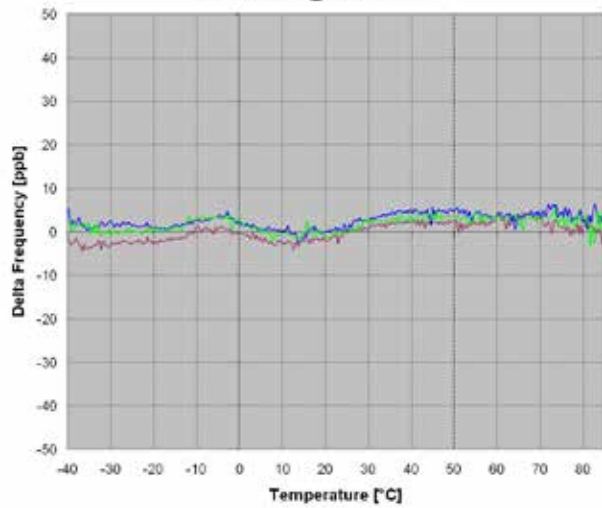

Phase Noise⁴

@ 20MHz
Typical Phase Noise

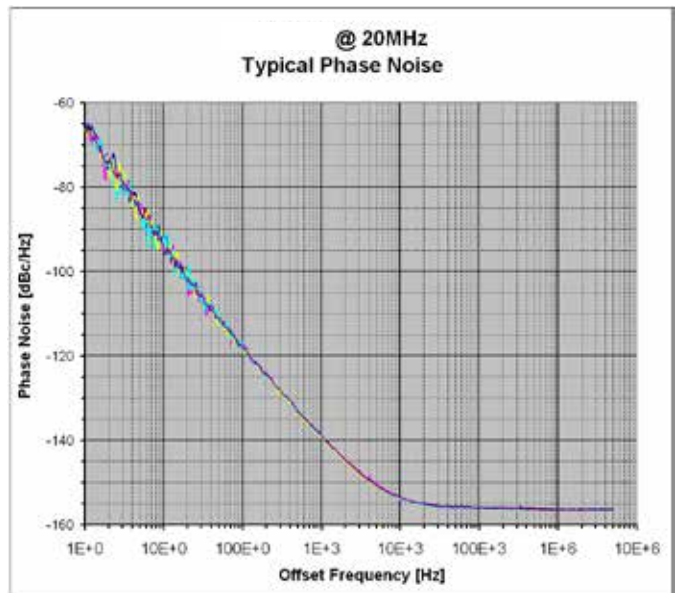

Performance Data

Frequency vs. Load

Frequency vs. Supply Voltage

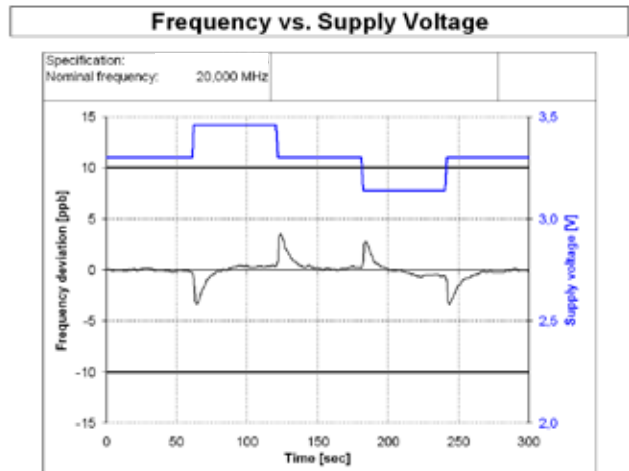
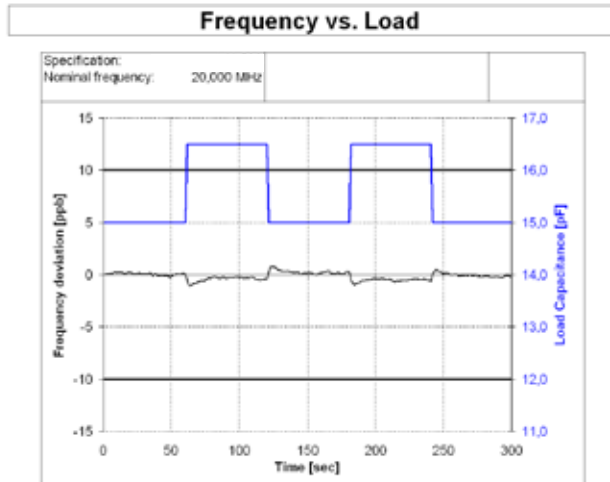

Aging

Aging: @ 20MHz

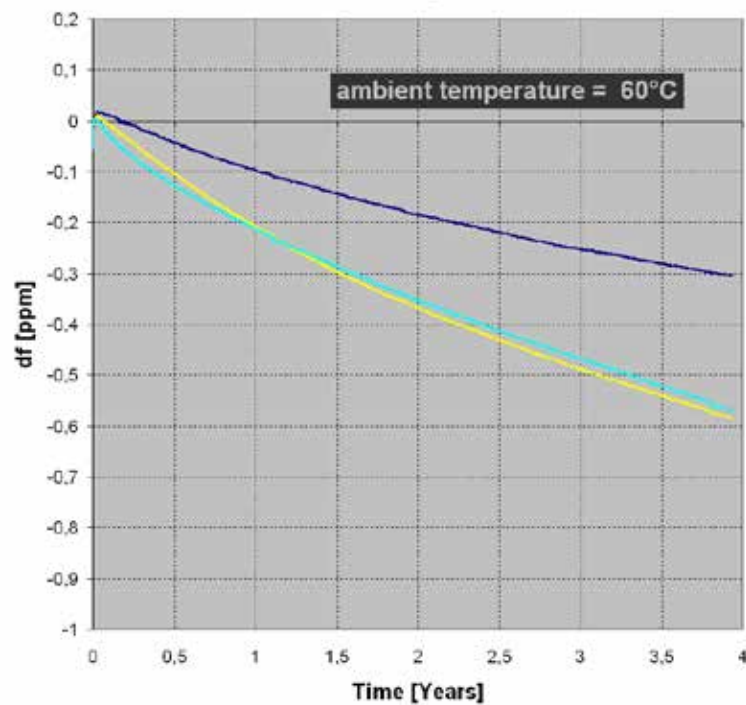

Recommended Reflow Profile

TP: max 260°C (@ solder joint, customer board level)

T_p: max: 10...30 sec

Additional Information:

This SMD oscillator has been designed for pick and place reflow soldering

SMD oscillators must be on the top side of the PCB during the reflow process.

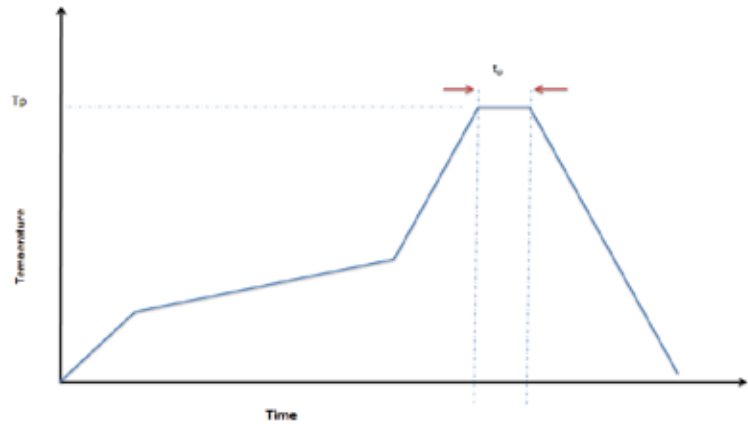

Standard Shipping Method (MX-505 / G355)

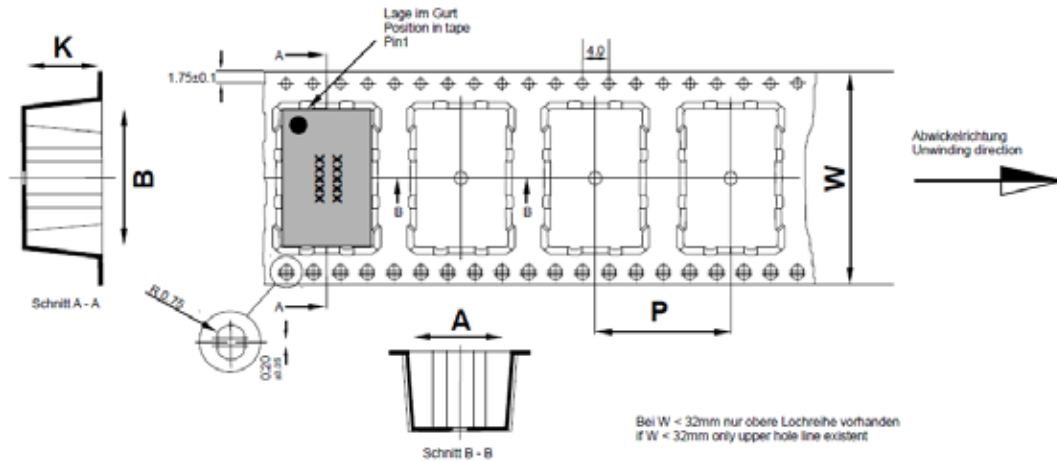

Maßangaben in mm: A, B und K Maße von Bauelement abhängig Fertigungstoleranzen entsprechen der DIN IEC 286-3	Dimension in mm: A, B und K are dependent upon component dimensions production tolerance complying DIN IEC 286-3
--	--

All dimensions in millimeters unless otherwise stated

Enclosure Type	Tape Width W (mm)	Quantity per meter	Quantity per reel	Dimension P
G355	24	83,3	850	12

Ordering Information^{1,3}

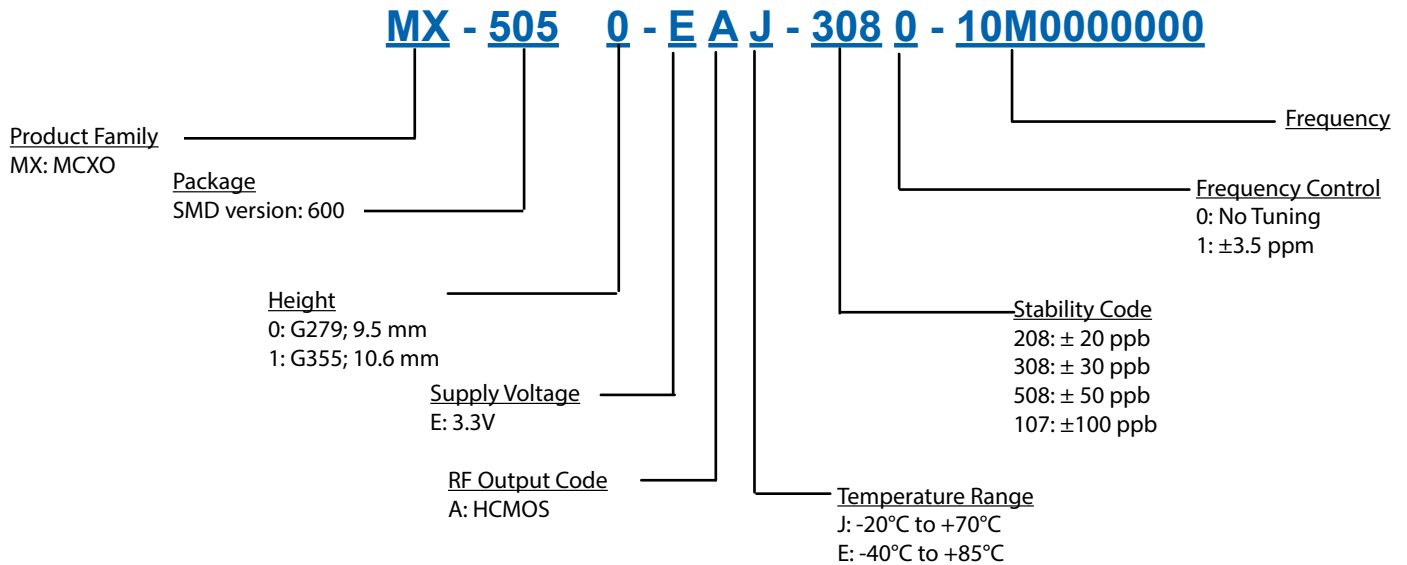

Notes:

1. Contact factory for other frequencies. Not all options and codes are available at all frequencies.
2. Unless otherwise stated conditions are valid at F=20MHz; V_s=3.3V; V_c=1.65; T=25°C; Output Signal=HCMOS; load=15pF
3. Contact factory for availability.
4. Phase noise degrades with increasing output frequency.

Subject to technical modification.



Microsemi Headquarters
One Enterprise, 9740 Vado, CA 92686 USA
Within the USA: +1 (800) 713-4113
Outside the USA: +1 (949) 330-6100
Direct: +1 (949) 330-6136
Fax: +1 (949) 215-4996
Email: sales.support@microsemi.com
www.microsemi.com

Microsemi, a wholly owned subsidiary of Microchip Technology Inc. (NASDAQ: MCHP), offers a comprehensive portfolio of semiconductor and system solutions for aerospace & defense, communications, data center and industrial markets. Products include high performance and radiation hardened analog mixed signal integrated circuits, FPGAs, SoCs and ASICs, power management products, timing and synchronization devices and precise time solutions, setting the world's standard for time, voice processing devices, RF solutions, discrete components, analog-to-digital converters and communication products, security technologies and isolated analog sensor products; Ethernet solutions; Power-over-Ethernet ICs and multiplexers, as well as custom design capabilities and services. Learn more at www.microsemi.com.

Microsemi makes no warranty, representation or guarantee regarding the information contained herein or the suitability of its products and services for any particular purpose, nor does Microsemi assume any liability whatsoever arising out of the application or use of any product or circuit. The products and services and any other products sold by Microsemi have been subject to limited testing and should not be used in conjunction with mission-critical equipment or applications. Any performance specifications are believed to be reliable but are not verified, and users must conduct and complete all performance and other testing of the products, alone and together with, as installed in, any end products. Users shall not rely on any data and performance specifications or parameters provided by Microsemi. It is the Buyer's responsibility to independently determine suitability of any products and to test and verify the same. The information provided by Microsemi hereunder is provided "as is, where is" and with all faults, and the entire risk associated with such information is entirely with the Buyer. Microsemi does not grant, explicitly or implicitly, to any party any patent rights, trademark, or any other IP rights, now or with regard to such information, except as anything disclosed by such information; information provided in this document is proprietary to Microsemi, and Microsemi reserves the right to make any changes to the information in this document at any product and service at any time without notice.

©2018 Microsemi, a wholly owned subsidiary of Microchip Technology Inc. All rights reserved. Microsemi and the Microsemi logo are registered trademarks of Microsemi Corporation. All other trademarks and service marks are the property of their respective owners.