Nominal frequency (f0)
49.152 MHz
Performance Specifications

Frequency stabilities					
Parameter	Min	Typical	Max	Units	Condition
Over all (df/f0)	-4.6		+4.6	ppm	-40...85°C include: Temp. Stab, supply, load stab, initial, 20 years aging
vs. operating temp. range (df/f@25°C)	-5		+5	ppb	-40...85°C
initial tolerance (df/f0)	-200		+200	ppb	@25 °C
vs. supply voltage change (df/f)	-3		+3	ppb	static; 3.3 V ±5 %
vs. load change (df/f)	-2		+2	ppb	static; Load +5 % -5 %
vs. aging / day (df/f)	-1		+1	ppb	after 30 days ; @ 25 °C
vs. aging / month (df/f)	-40		+40	ppb	after 30 days ; @ 25 °C
vs. aging / year (df/f)	-100		+100	ppb	after 30 days ; @ 25 °C
Holdover/Drift	-1		+1	ppb	over 24 hours and ±2.8°C
			10	ppb [pk-pk]	over 24 hours; -40...85°C
Note:	S3E compliant according GR1244				

RF output					
Parameter	Min	Typical	Max	Units	Condition
Signal	LVCMOS				
Load	13.5	15	16.5	pF	
Fan out					
Rise Time			5	ns	@10 to 90 %Vout
Fall Time			5	ns	@90 to 10 %Vout
Duty cycle	45		55	%	@1.65 V
V Low			0.4	V	
V High	2.4			V	

RF output					
Parameter	Min	Typical	Max	Units	Condition
Sub Harmonics			-40	dBc	
Spurious			-90	dBc	

Supply voltage					
Parameter	Min	Typical	Max	Units	Condition
Supply voltage (Vs)	3.14	3.3	3.47	V	
Current consumption steady state			400	mA	@ Vsnom & 25 °C
			700	mA	@ Vsnom & -40 °C
Current consumption during warm up			1200	mA	@ Vs

Additional Parameters					
Parameter	Min	Typical	Max	Units	Condition
Warm up time			5	min	@ 25 °C to final frequency
Phase Noise		-77		dBc/Hz	@1Hz
		-107		dBc/Hz	@10Hz
		-135		dBc/Hz	@100Hz
		-146		dBc/Hz	@1kHz
		-150		dBc/Hz	@10kHz
		-150		dBc/Hz	@100kHz
Jitter			0.3	psec (RMS)	@ 12kHz to 5MHz
MTIE		0.2		ns	1.0 sec
		2		ns	10.0 sec
		10		ns	100.0 sec
		30		ns	1000.0 sec
TDEV		0.003 ns			1 s
		0.04 ns			10 s
		0.4 ns			100 s
Additional information	wander generation tdev & mtie at 1 mHz constant temp: meets GR-1244 mask wander generation tdev & mtie at 1 mHz variable temp: meets GR-1244 mask				
Processing & Packing	handling&processing note				

Additional Environmental Conditions	
Parameter	Description
RoHS compliance	100% RoHS 6 compliant
Washable	washable device
MSL-Level	1
ESD HBM	JESD22-A114F Class 1C - 10* 2000V
Mechanical Shock	MIL-STD-202 Meth 213B Cond. C - 100g 6ms 6 shocks in each direction
Vibration, Sine	JESD22-B103 Cond.2 - 10g 10-2000Hz 4x in each 3 axis 4min sweep time
Moisture Sen. Level	JESD22-A113-B - only if > MSL 1
Solderability	J-STD-002C Cond. A, Trough hole device; Cond.B, SMD (correspond to MIL-STD-883 Meth 2003) - 255°C (dipping Time 5 ±0,5sec.) Dip&Look with 8h damp pre-treatment: solder wetting >95%
High temp operating life(HTOL)	MIL-STD-202 Meth108A Cond C - 1000h @ 105°C under voltage
Low temp operating life(LTOL)	IEC 60068-2-1 Cond. Ae - Ta= -40°C, >1000 hours with bias for OCXO

Additional Environmental Conditions

Parameter	Description
Reflow Simulation Test	MIL-STD-202G Meth 210F Cond. K - Total 3x Lead free profile (for SMD)
Temperature Cycling	MIL-STD-883G Meth.1010.8 Cond.B - 1000cycles -55/+125°C; cycle time 30 min.

Absolute Maximum Ratings

Parameter	Min	Typical	Max	Units	Condition
Supply voltage (Vs)			5.5	V	
Operable temperature range	-40		+85	°C	
Storage temperature range	-40		+85	°C	

Enclosure

G275

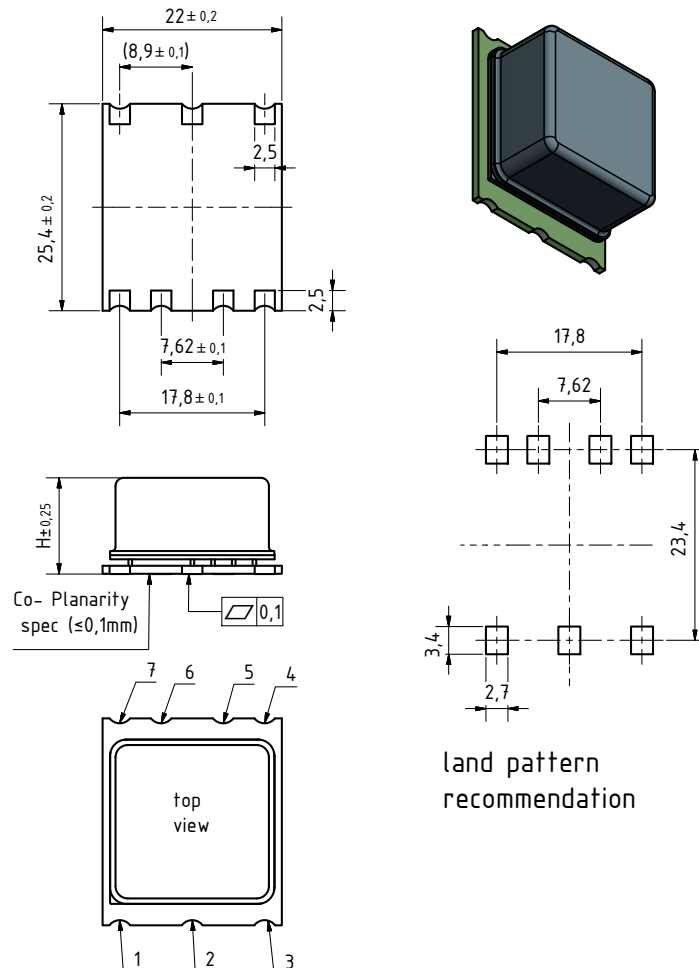

all units in mm

Enclosure Info

Parameter	Description
Type	G275D

Enclosure Info	
Parameter	Description
Height (H)	12.1 mm
Weight	9 g
Pin Connections	1: I.C. (Do not connect) 2: N.C. 3: Vs (supply voltage input) 4: RF-Output 5: N.C. 6: N.C. 7: GND
Marking	OX-221-9102 49,152 MHz Ser.No. AYYWW * * pin-1 marking
Package cover material	Metal
Package base material	FR4

Solder profile

TP: max 260°C (@ solder joint, customer board level)

T_p: max: 10...30 sec

Additional Information:

This SMD oscillator has been designed for pick and place reflow soldering

SMD oscillators must be on the top side of the PCB during the reflow process.

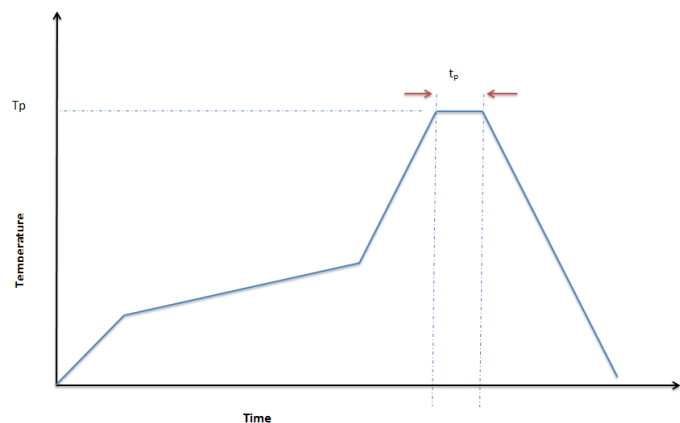

Standard shipping method

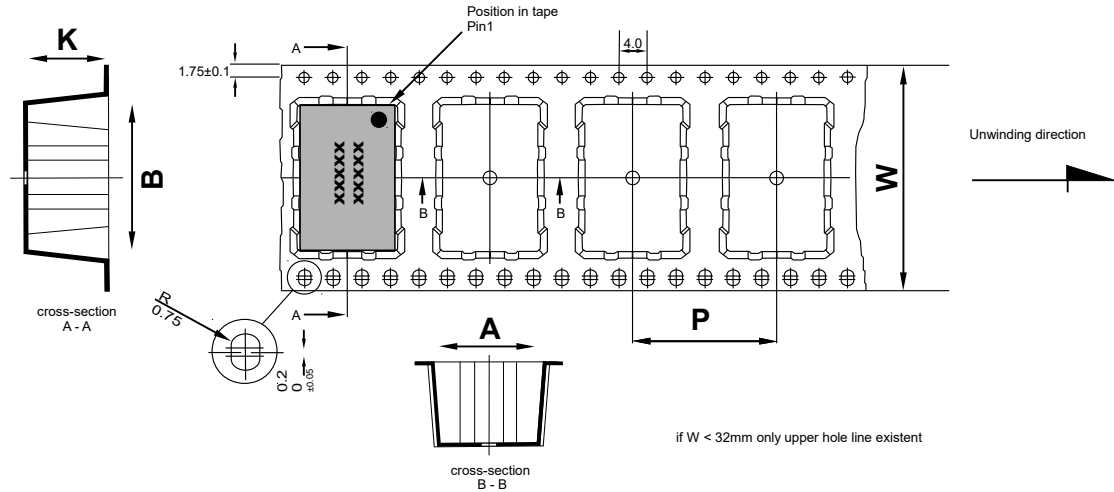

Dimension in mm:

A, B and K are dependent upon component dimensions
production tolerance complying DIN IEC 286-3

All dimensions in millimeters unless otherwise stated

Tape Info						
Tape width W [mm]	Quantity per meter	Quantity per reel	P [mm]	A [mm]	B [mm]	K [mm]
44	35.7	175	28	22.5	25.9	12.8

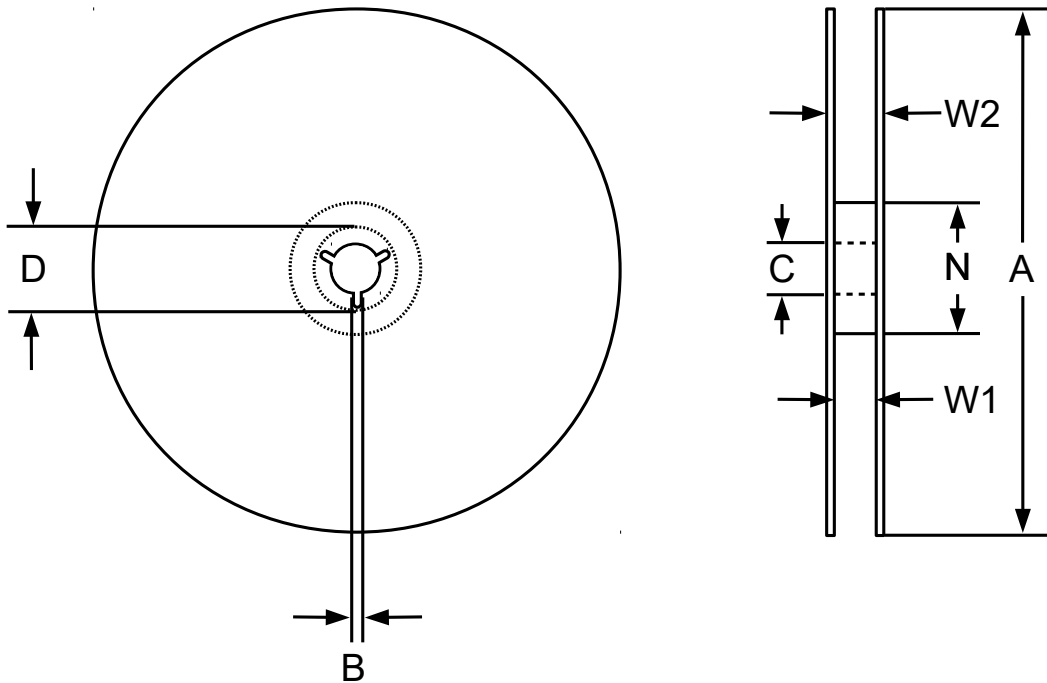

Reel Info						
A [mm]	B [mm]	Size C [mm]	D [mm]	N [mm]	W1 [mm]	W2 [mm]
330	1.5	13	20.2	100	45.5	49.1

Notes: Unless otherwise stated all values are valid after warm-up time and refer to typical conditions for supply voltage, frequency control voltage, load, temperature (25°C). Subject to technical modification.



Microsemi, a wholly owned subsidiary of Microchip Technology Inc. (Nasdaq: MCHP), offers a comprehensive portfolio of semiconductor and system solutions for aerospace & defense, communications, data center and industrial markets. Products include high-performance and radiation-hardened analog mixed-signal integrated circuits, FPGAs, SoCs and ASICs; power management products; timing and synchronization devices and precise time solutions, setting the world's standard for time; voice processing devices; RF solutions; discrete components; enterprise storage and communication solutions, security technologies and scalable anti-tamper products; Ethernet solutions; Power-over-Ethernet ICs and midspans; as well as custom design capabilities and services. Learn more at www.microsemi.com.

Microsemi Headquarters

One Enterprise, Aliso Viejo, CA 92656 USA

Within the USA: +1 (800) 713-4113

Outside the USA: +1 (949) 380-6100

Sales: +1 (949) 380-6136

Fax: +1 (949) 215-4996

email: sales.support@microsemi.com

www.microsemi.com

Microsemi makes no warranty, representation, or guarantee regarding the information contained herein or the suitability of its products and services for any particular purpose, nor does Microsemi assume any liability whatsoever arising out of the application or use of any product or circuit. The products sold hereunder and any other products sold by Microsemi have been subject to limited testing and should not be used in conjunction with mission-critical equipment or applications. Any performance specifications are believed to be reliable but are not verified, and Buyer must conduct and complete all performance and other testing of the products, alone and together with, or installed in, any end-products. Buyer shall not rely on any data and performance specifications or parameters provided by Microsemi. It is the Buyer's responsibility to independently determine suitability of any products and to test and verify the same. The information provided by Microsemi hereunder is provided "as is, where is" and with all faults, and the entire risk associated with such information is entirely with the Buyer. Microsemi does not grant, explicitly or implicitly, to any party any patent rights, licenses, or any other IP rights, whether with regard to such information itself or anything described by such information. Information provided in this document is proprietary to Microsemi, and Microsemi reserves the right to make any changes to the information in this document or to any products and services at any time without notice.

©2018 Microsemi, a wholly owned subsidiary of Microchip Technology Inc. All rights reserved. Microsemi and the Microsemi logo are registered trademarks of Microsemi Corporation. All other trademarks and service marks are the property of their respective owners

Disclaimer

We reserve the right to make changes to the product(s) and or information contained herein without notice. No liability is assumed as a result of their use or application. No rights under any patent accompany the sale of any such product(s) or information.

List of appendices

Appendix_OX-221-9102_49M152

II

Appendix handling&processing note

IV

Typical Performance Data

Typical MTIE

OX-221-9102-49M152

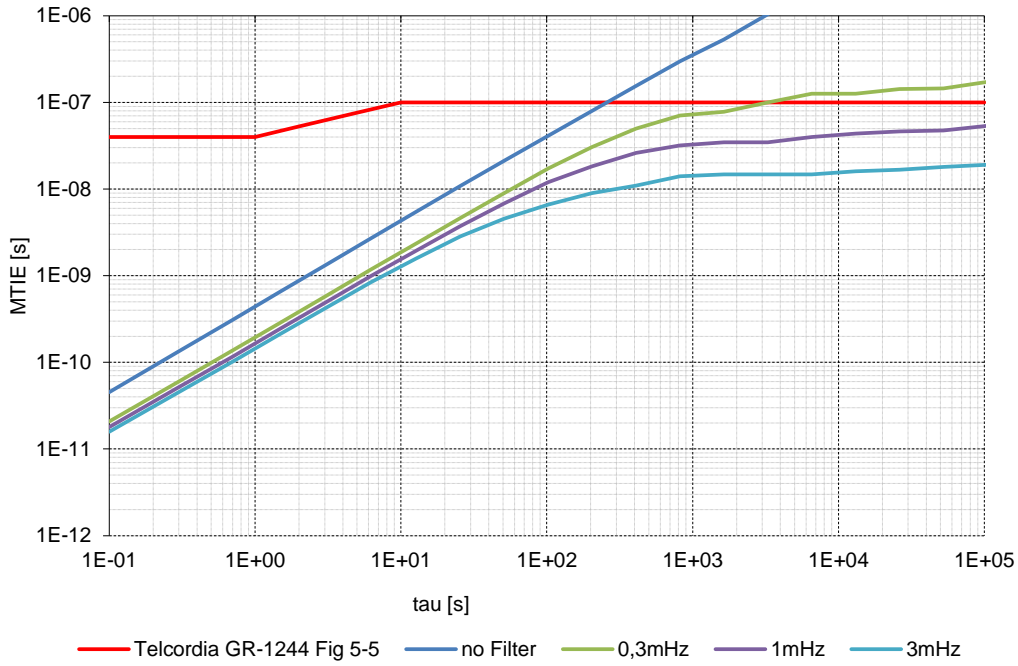

Typical TDEV

OX-221-9102-49M152

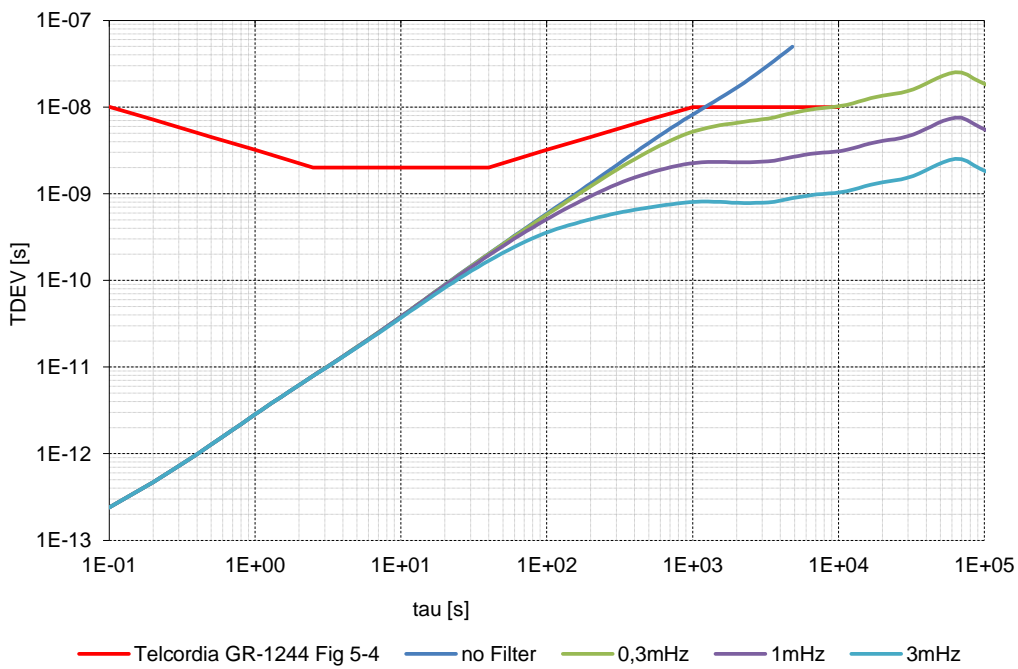

Filtered (0,3mHz; 1mHz; 3mHz) curves are simulated base on measured frequency / Phase data

Typical Phase Noise and Jitter

OX-221-9102-49M152

Agilent E5052B Signal Source Analyzer

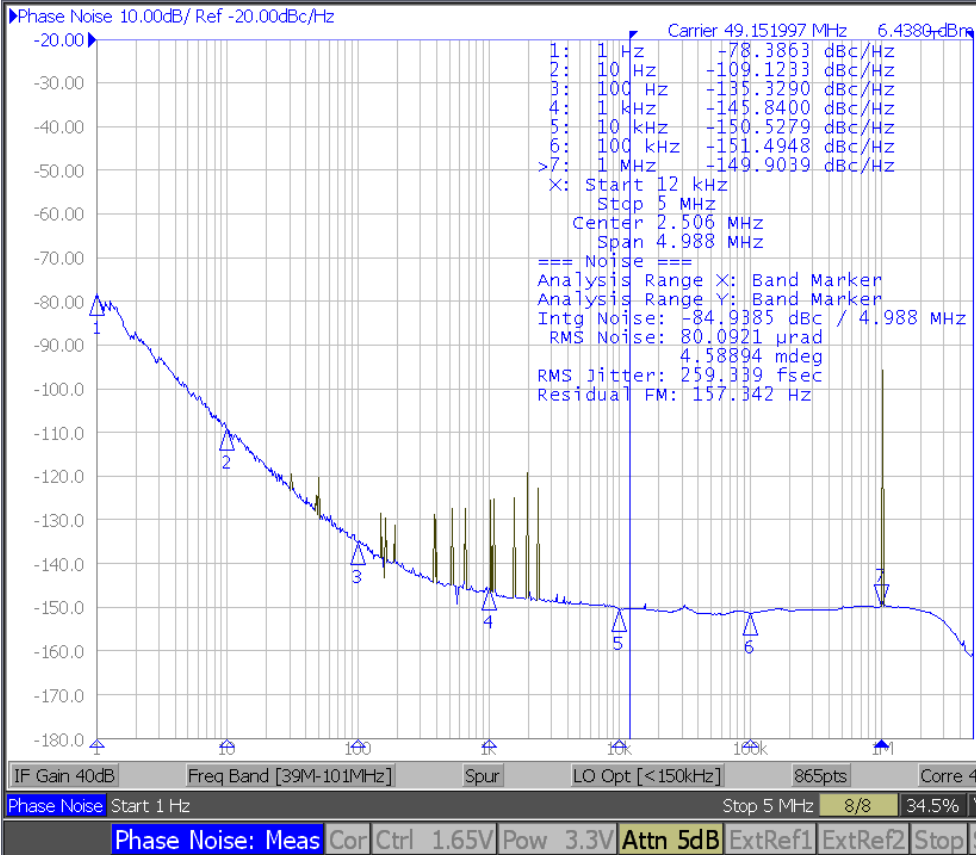

Resize

Average

Averaging
Restart

Avg Factor
8

Averaging
ON

Correlation
4

Return

Application

Unless otherwise noted, the products listed in the catalogue are designed for use with ordinary electrical devices, such as stationary and portable communication, control, measurement equipment etc.. They are designed and manufactured to meet a high degree of reliability (lifetime more than 15 years) under normal „commercial“ application conditions. Products dedicated for automotive and H-Rel applications are specifically identified for these applications.

If you intend to use these „commercial“ products for airborne, space or critical transport applications, nuclear power control, medical devices with a direct impact on human life, or other applications which require an exceptionally high degree of reliability or safety, please contact the manufacturer.

Electrostatic Sensitivity

Crystal oscillators are electrostatic sensitive devices. Proper handling according to the established ESD handling rules as in IEC 61340-5-1 and EN 100015-1 is mandatory to avoid degradations of the oscillator performance due to damages of the internal circuitry by electrostatics. If not otherwise stated, our oscillators meet the requirements of the Human Body Model (HBM) according to JESD22-A114F.

Handling

Excessive mechanical shocks during handling as well as manual and automatic assembly have to be avoided. If the oscillator was unintentionally dropped or otherwise subject to strong shocks, please verify that the electrical function is still within specification.

Improper handling may also deteriorate the coplanarity of bended leads of SMD components.

Soldering

Oscillators can be processed using conventional soldering processes such as wave soldering, convection, infrared, and vapour phase reflow soldering under normal conditions. Solderability is guaranteed for one year storage under normal climatic conditions (+5°C to +35°C @ 40% to 75% relative humidity), however typically sufficient solderability –depending on the process – is maintained also for longer time periods. In cases of doubt, components older than one year should undergo a sample solderability test.

The recommended reflow solder profile for SMT components is according IPC/JEDEC J-STD-020 (latest revision)

SMD oscillators must be on the top side of the PCB during the reflow process.

After reflow soldering the frequency of the products may have shifted several ppm, which relaxes after several hours or days, depending on the products. For details please contact the manufacturer.

Cleaning

Cleaning is only allowed for hermetically sealed oscillators. Devices with non hermetical enclosures (e.g. with trimmer holes) shall not be cleaned by soaking or in vapour, because residues from the cleaning process may penetrate into the interior, and degrade the performance.

Our products are laser marked. The marking of our oscillators is resistant to usual solvents, such as given in IEC 60068-2-45 Test XA. For applicable test conditions see IEC 60679-1.

Ultrasonic cleaning is usually not harmful to oscillators at ultrasonic frequencies of 20kHz at the sound intensities conventional in industry. Sensitive devices may suffer mechanical damage if subjected to 40kHz ultrasound at high sound pressure. In cases of doubt, please conduct tests under practical conditions with the oscillators mounted on the PC board.

Hermetical Seal

If the device is specified as hermetically sealed, it meets the requirements of IEC 60679-1, i.e. for enclosures with a volume smaller than 4000mm³ the leak rate is below 5*10⁻⁸ bar cm³/s, for larger enclosures it is below 1*10⁻⁶ bar cm³/s, tested according to IEC 60068-2-17 Test Qk.

Glass feed-throughs may be damaged as a result of mechanical overload, such as bending the connection leads or cutting them with an unappropriated tool. In order to avoid microcracking, the wire must be held fixed in position by a pressure pad between glass feed-through and the bending point during the bending process. Check: there should be no damaged edges on the glass feed-through after the bending.

Tape & Reel

The packing in tape and reel is according to IEC 60286-3.

Details see tape & reel data sheets.

Qualification

Vectron products are undergoing regular qualification/reliability tests as per product family definition. Results are available upon request. Customer specific qualification tests are subject to agreement.

If not otherwise stated, the product qualifications are performed according to IEC 60679-5 or other valid industry standards.

Screening

Our oscillators are 100% tested, and all key manufacturing processes are controlled by Statistical Process Control (SPC). Additional screening is therefore usually not required.

On request, we can perform screening tests according to MIL-PRF-55310, class B for discrete or hybrid constructions of commercial (COTS) products. For special requirements see the High Reliability Clock section.

Demounting/Desoldering of Oscillator device for analysis:

The removal or desoldering of oscillators from customer application after SMT process may cause damage to the device if not handled appropriately. It may lead to parametric change such as frequency shift (like OCXO: up to +/- 200 ppb) . It is utmost important to minimize the direct heat exposure to the device in order to avoid such effects. Use of hot air gun for desoldering should be avoided.

A mechanical stress could also destroy the part, if exposed to excessive mechanical shock after removal process. Appropriate shock protection & ESD designated packaging must be used to avoid any external mechanical shock for FA return process.

In general, the products* withstand the tests listed in the following Table 1, which are based on valid industry standards.

***Additional note:** Test conditions could vary for different product families and individual product specifications depending on the customer as well as product requirements.

Recommended Environmental Test Conditions

Table 1

Test	Test condition	Test Standard
Dimensions	acc. outline drawing	MIL-STD-883 Meth2016
External visual	no visible damage	MIL-STD-883 Meth2009
Internal visual	30-50x	MIL-STD-883 Meth2014
Electrostatic discharge (ESD) sensitivity testing Human Body Model (HBM)	10 discharges, both polarities, 1kV...8kV	JESD 22-A114F
Seal Fine/Gross Leak	only for hermetically sealed parts 100% tested	MIL-STD-883 Meth1014 A1/C4
Solderability	255°C (dipping Time 5 ±0,5sec.) Dip&Look with 8h damp pre-treatment: solder wetting >95%	J-STD-002C Cond. A, Trough hole device; Cond. B, SMD (correspond to MIL-STD-883 Meth 2003)
Reflow Simulation Test	3X Lead free profile	J-STD-020D
Mechanical Shock	1. 100g 6ms 6 shocks in each direction; 2. 1500G 0,5ms 6 shocks in each direction.	1. MIL-STD-202 Meth 213B Cond. C; 2. MIL-STD-202 Meth 213B Cond. F (for ceramics parts).
Free fall	Test Ed procedure 1, 2 drops from 1m height	IEC 60068-2-32
Vibration, Sine	20g 20-2000Hz 4x in each 3 axis 4min sweep time	MIL-STD-883 Meth 2007.3 Cond A
Vibration, random	optional on customers request	MIL-STD-202 Meth214A Figure 214-1
Temperature Cycling	1.1000 cycles - 55/+125°C; cycle time 30 min.; 2.1000 cycles - 40/+125°C;cycle time 30 min.	1. MIL-STD-883G Meth1010.8 Cond. B 2. JESD22-A104-D Cond. G
Low temperature operating Life (LTOL)	Ta= -40°C, >1000 h	IEC 60068-2-1
Steady State Temperature Humidity Bias Life Test	Non hermetic parts 85°C/85% RH 1008h	JESD22-A101-C
High Temperature Storage Operating Life (HTOL)	1000h @ 105°C under voltage	MIL-STD-202 Meth108A Cond C
Active Aging at Elevated Temperatures	1000h @ 85°C with fit calculation (for not OCXO)	MIL-PRF-55310 Meth.4.8.35
Active Aging at Room Temperature	1000h with fit calculation- only for OCXO @crystal operating temp.	MIL-PRF-55310 Meth.4.8.35
Immersion in cleaning solvents		IEC 60068-2-45 Test Xa ; IEC 60068-2-70 Test Xb (rubbing finger)