

APT30D120SG
Datasheet
Ultrafast Soft Recovery Rectifier Diode

Final
March 2018



Contents

1	Revision History	1
1.1	Revision A	1
2	Product Overview	2
2.1	Features	2
2.2	Benefits	2
2.3	Applications	2
3	Electrical Specifications	3
3.1	Absolute Maximum Ratings	3
3.2	Typical Electrical Performance	3
3.3	Typical Performance Curves	5
3.4	Reverse Recovery Overview	8
4	Package Specification	9
4.1	Package Outline Drawing	9

1 Revision History

The revision history describes the changes that were implemented in the document. The changes are listed by revision, starting with the most current publication.

1.1 Revision A

Revision A was published in March 2018. It is the first publication of this document.

2 Product Overview

This section outlines the product overview for the APT30D120SG device.

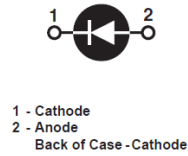
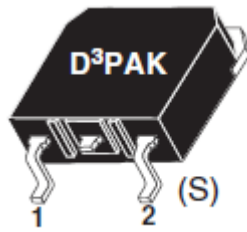

2.1 Features

The following are key features of the APT30D120SG device:

- Ultrafast recovery times
- Soft recovery characteristics
- Low forward voltage
- Low leakage current
- RoHS compliant

2.2 Benefits

The following are benefits of the APT30D120SG device:

- Low switching losses
- Low noise (EMI) switching
- Cooler operation
- Higher reliability systems
- Increased system power density

2.3 Applications

The APT30D120SG device is designed for the following applications:

- Power factor correction (PFC)
- Anti-parallel diode
 - Switchmode power supply
 - Inverters
- Freewheeling diode
 - Motor controllers
 - Converters
 - Inverters
- Snubber diode

3 Electrical Specifications

This section details the electrical specifications for the APT30D120SG device.

3.1 Absolute Maximum Ratings

The following table shows the absolute maximum ratings for the APT30D120SG device.

All Ratings: $T_c = 25\text{ }^\circ\text{C}$ unless otherwise specified.

Table 1 • Absolute Maximum Ratings

Symbol	Parameter	Ratings	Unit
V_R	Maximum DC reverse voltage	1200	V
V_{RRM}	Maximum peak repetitive reverse voltage	1200	
V_{RWM}	Maximum working peak reverse voltage	1200	
$I_{F(AV)}$	Maximum average forward current ($T_C = 128\text{ }^\circ\text{C}$, duty cycle = 0.5)	30	A
$I_{F(RMS)}$	RMS forward current	59	
I_{FSM}	Non-repetitive forward surge current ($T_J = 45\text{ }^\circ\text{C}$, 8.3 ms)	210	
T_J, T_{STG}	Operating and storage temperature range	-55 to 175	$^\circ\text{C}$
T_L	Lead temperature for 10 s	300	

3.2 Typical Electrical Performance

The following table shows the static electrical characteristics of the APT30D120SG device.

Table 2 • Static Electrical Characteristics

Symbol	Characteristic	Test Conditions	MIN	TYP	MAX	Unit
V_F	Forward voltage	$I_F = 30\text{ A}$		2.0	2.5	V
		$I_F = 60\text{ A}$		2.3		
		$I_F = 30\text{ A}, T_J = 125\text{ }^\circ\text{C}$		1.8		
I_{RM}	Maximum reverse leakage current	$V_R = V_R\text{ rated}$			250	μA
		$V_R = V_R\text{ rated}, T_J = 125\text{ }^\circ\text{C}$			500	
C_T	Junction capacitance	$V_R = 200\text{ V}$		32		pF

The following table shows the dynamic characteristics of the APT30D120SG device.

Table 3 • Dynamic Characteristics

Symbol	Characteristic	Test Conditions	MIN	TYP	MAX	Unit
t_{rr}	Reverse recovery time	$I_F = 1\text{ A}$ $di_F/dt = -100\text{ A}/\mu\text{s}$ $V_R = 30\text{ V}$ $T_J = 25\text{ }^\circ\text{C}$		31		ns
t_{rr}	Reverse recovery time	$I_F = 30\text{ A}$		370		
Q_{rr}	Reverse recovery charge	$di_F/dt = -200\text{ A}/\mu\text{s}$ $V_R = 800\text{ V}$		660		nC
I_{RRM}	Maximum reverse recovery current	$T_C = 25\text{ }^\circ\text{C}$		5		A
t_{rr}	Reverse recovery time	$I_F = 30\text{ A}$		500		ns
Q_{rr}	Reverse recovery charge	$di_F/dt = -200\text{ A}/\mu\text{s}$ $V_R = 800\text{ V}$		3450		nC
I_{RRM}	Maximum reverse recovery current	$T_C = 125\text{ }^\circ\text{C}$		12		A
t_{rr}	Reverse recovery time	$I_F = 30\text{ A}$		220		ns
Q_{rr}	Reverse recovery charge	$di_F/dt = -1000\text{ A}/\mu\text{s}$ $V_R = 800\text{ V}$		4650		nC
I_{RRM}	Maximum reverse recovery current	$T_C = 125\text{ }^\circ\text{C}$		37		A

The following table shows the thermal and mechanical characteristics of the APT30D120SG device.

Table 4 • Thermal and Mechanical Characteristics

Symbol	Characteristic/Test Conditions	MIN	TYP	MAX	Unit
$R_{\theta JC}$	Junction-to-case thermal resistance			0.61	$^\circ\text{C}/\text{W}$
$R_{\theta JA}$	Junction-to-ambient thermal resistance			40	
W_T	Package weight		0.14		oz
			4.0		g

3.3 Typical Performance Curves

This section shows the typical performance curves for the APT30D120SG device.

Figure 1 • Maximum Effective Thermal Impedance, Junction-to-Case vs. Pulse Duration

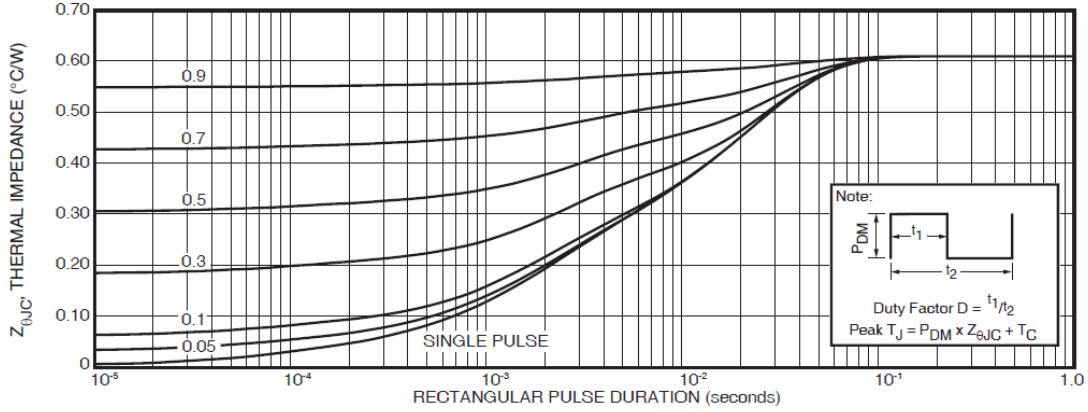

Figure 2 • Transient Thermal Impedance Model

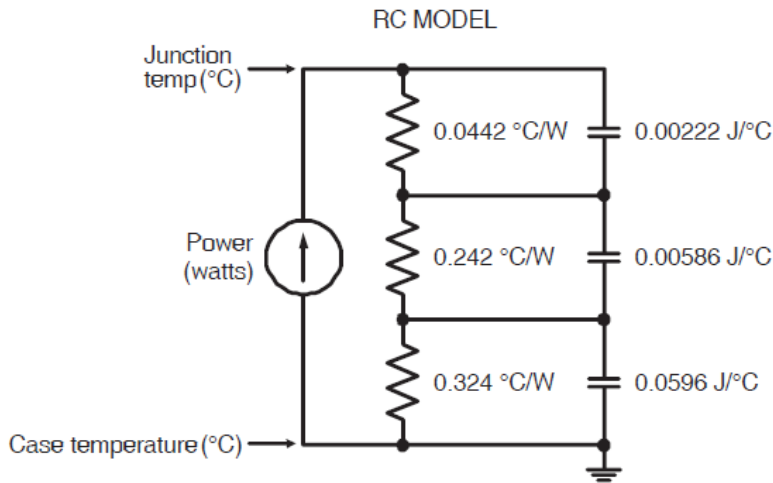

Figure 3 • Forward Current vs. Forward Voltage

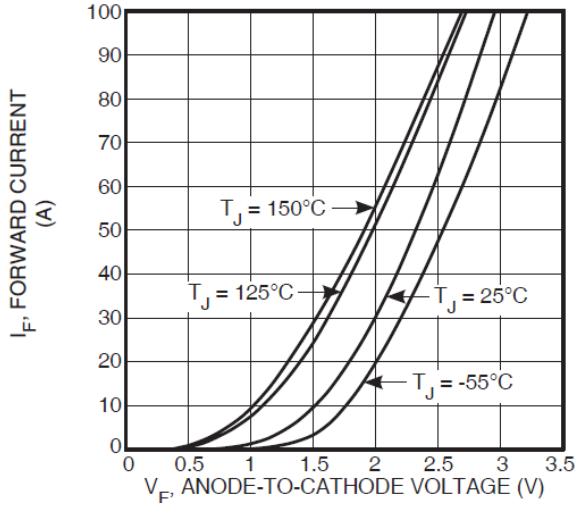

Figure 4 • t_{rr} vs. Current Rate of Change

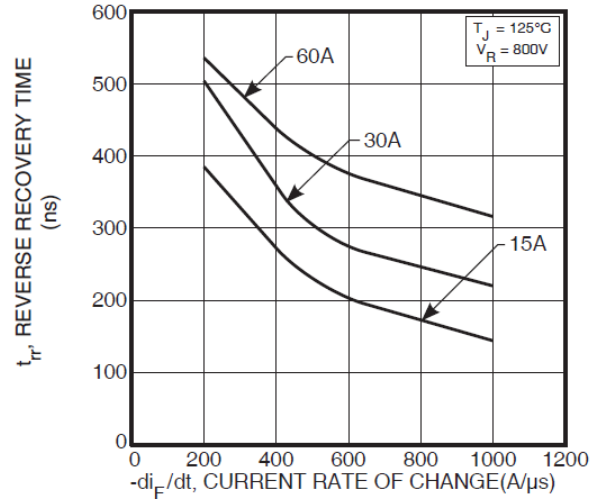

Figure 5 • Q_{rr} vs. Current Rate of Change

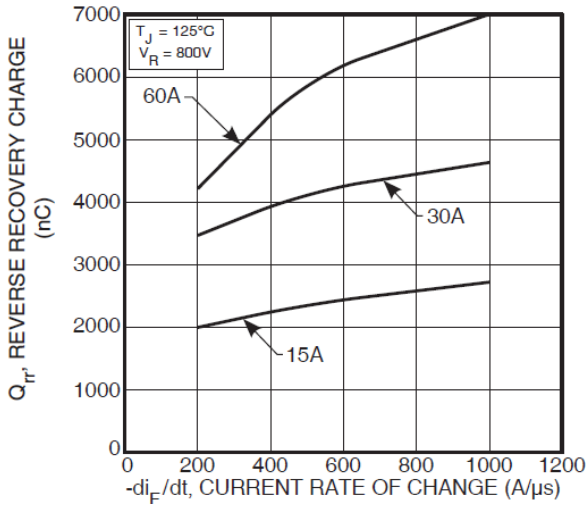

Figure 6 • I_{RRM} vs. Current Rate of Change

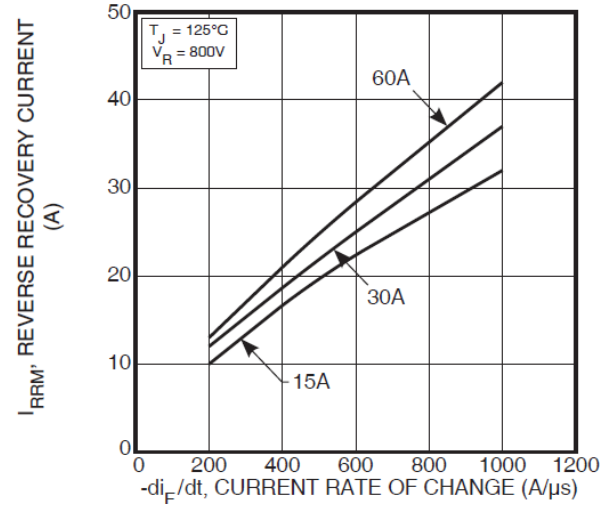

Figure 7 • Dynamic Parameters vs. Junc Temp

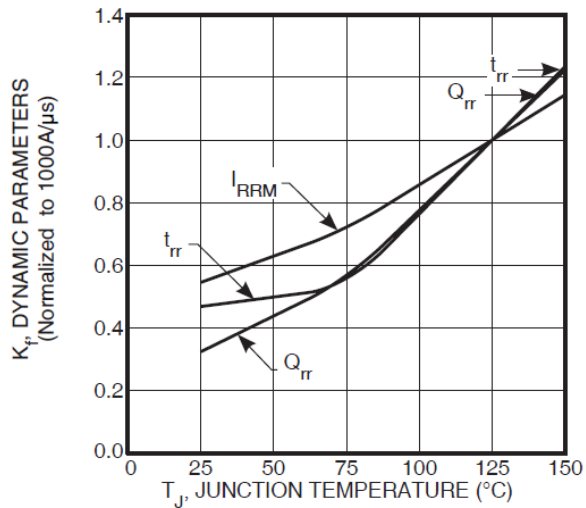

Figure 8 • Max Avg Forward Current vs. Case Temp

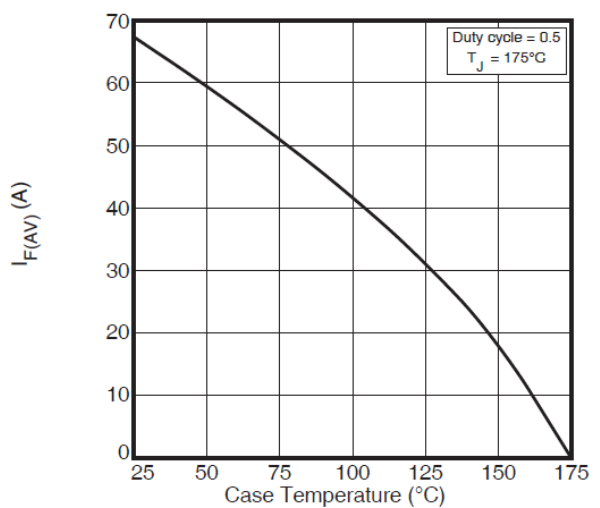
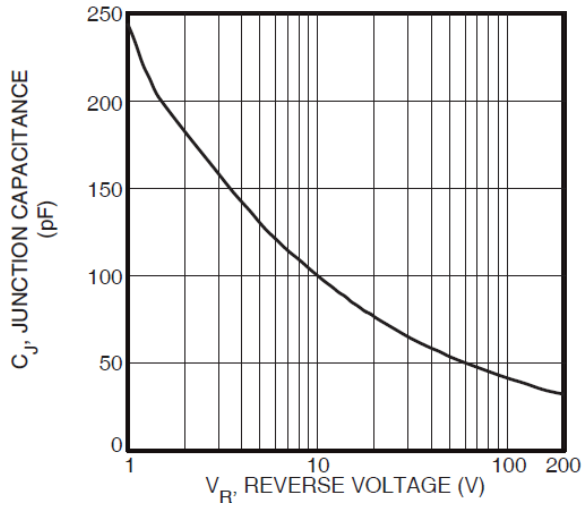

Figure 9 • Junction Capacitance vs. Reverse Voltage



3.4 Reverse Recovery Overview

The following illustration shows the reverse recovery testing and measurement information for the APT30D120SG device.

Figure 10 • Diode Test Circuit

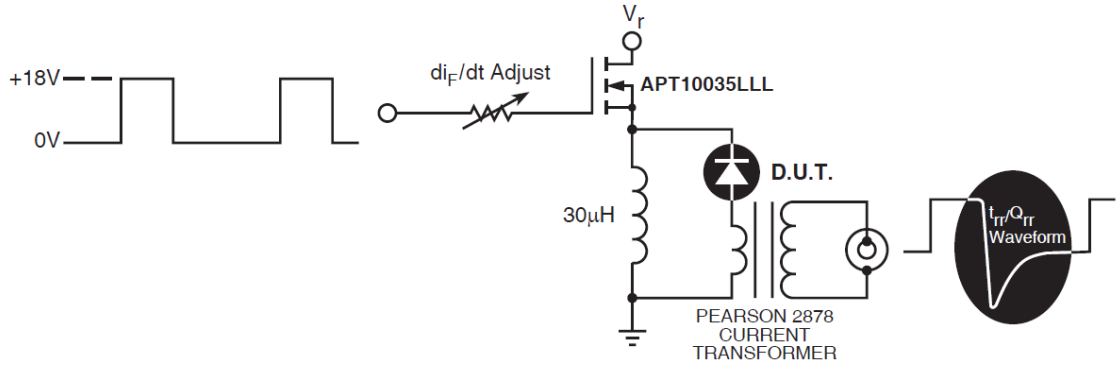
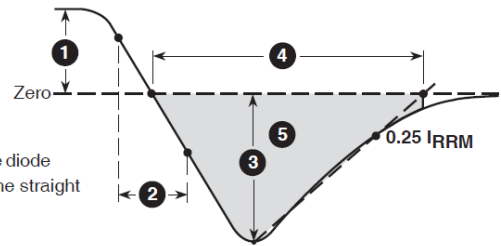

Figure 11 • Diode Reverse Recovery Waveform and Definitions

- 1 I_F - Forward Conduction Current
- 2 di_F/dt - Rate of Diode Current Change Through Zero Crossing.
- 3 I_{RRM} - Maximum Reverse Recovery Current.
- 4 t_{rr} - Reverse Recovery Time, measured from zero crossing where diode current goes from positive to negative, to the point at which the straight line through I_{RRM} and $0.25 \cdot I_{RRM}$ passes through zero.
- 5 Q_{rr} - Area Under the Curve Defined by I_{RRM} and t_{rr} .



4 Package Specification

This section outlines the package specification for the APT30D120SG device.

4.1 Package Outline Drawing

This section details the D3PAK package drawing of the APT30D120SG device. Dimensions are in millimeters and (inches).

Figure 12 • Package Outline Drawing

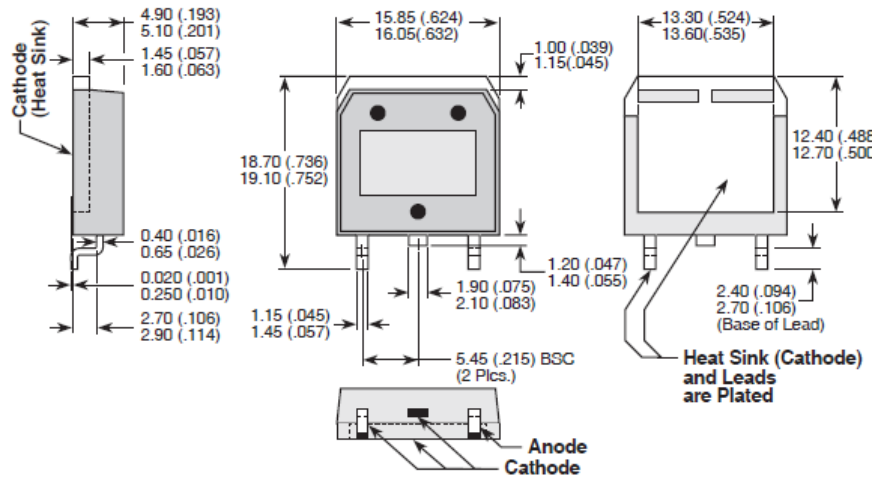

**Microsemi Corporate Headquarters**

One Enterprise, Aliso Viejo,
CA 92656 USA
Within the USA: +1 (800) 713-4113
Outside the USA: +1 (949) 380-6100
Fax: +1 (949) 215-4996
Email: sales.support@microsemi.com
www.microsemi.com

© 2018 Microsemi Corporation. All rights reserved. Microsemi and the Microsemi logo are trademarks of Microsemi Corporation. All other trademarks and service marks are the property of their respective owners.

Microsemi makes no warranty, representation, or guarantee regarding the information contained herein or the suitability of its products and services for any particular purpose, nor does Microsemi assume any liability whatsoever arising out of the application or use of any product or circuit. The products sold hereunder and any other products sold by Microsemi have been subject to limited testing and should not be used in conjunction with mission-critical equipment or applications. Any performance specifications are believed to be reliable but are not verified, and Buyer must conduct and complete all performance and other testing of the products, alone and together with, or installed in, any end-products. Buyer shall not rely on any data and performance specifications or parameters provided by Microsemi. It is the Buyer's responsibility to independently determine suitability of any products and to test and verify the same. The information provided by Microsemi hereunder is provided "as is, where is" and with all faults, and the entire risk associated with such information is entirely with the Buyer. Microsemi does not grant, explicitly or implicitly, to any party any patent rights, licenses, or any other IP rights, whether with regard to such information itself or anything described by such information. Information provided in this document is proprietary to Microsemi, and Microsemi reserves the right to make any changes to the information in this document or to any products and services at any time without notice.

Microsemi Corporation (Nasdaq: MSCC) offers a comprehensive portfolio of semiconductor and system solutions for aerospace & defense, communications, data center and industrial markets. Products include high-performance and radiation-hardened analog mixed-signal integrated circuits, FPGAs, SoCs and ASICs; power management products; timing and synchronization devices and precise time solutions, setting the world's standard for time; voice processing devices; RF solutions; discrete components; enterprise storage and communication solutions; security technologies and scalable anti-tamper products; Ethernet solutions; Power-over-Ethernet ICs and midspans; as well as custom design capabilities and services. Microsemi is headquartered in Aliso Viejo, California, and has approximately 4,800 employees globally. Learn more at www.microsemi.com.

050-5946