



Glass Passivated Three Phase Rectifier Bridge

VRRM 800 to 1800V

ID 75Amp

Applications

- Three phase rectifiers for power supplies
- Rectifiers for DC motor field supplies
- Battery charger rectifiers
- Input rectifiers for variable frequency drives

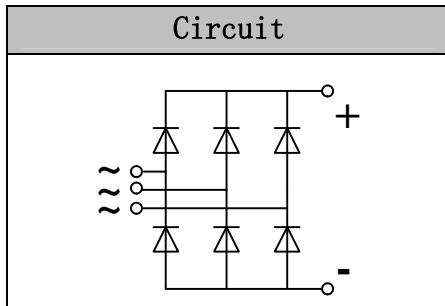

Features

- Three phase bridge rectifier
- Blocking voltage:800 to 1800V
- Heat transfer through aluminum oxide DBC ceramic isolated metal baseplate
- Glass passivated chip

Module Type

TYPE	VRRM	VRSM
MSDM75-08	800V	900V
MSDM75-12	1200V	1300V
MSDM75-16	1600V	1700V
MSDM75-18	1800V	1900V

Maximum Ratings

Symbol	Item	Conditions	Values	Units
ID	Output current (D.C)	Tc=100°C	75	A
IFSM	Forward surge current, max.	t=10mS Tvj =45°C	750	A
i ² t	Value for fusing		2800	A ² s
Visol	Isolation Breakdown Voltage(R.M.S)	a.c.50HZ;r.m.s.;1min	3000	V
Tvj	Operating Junction Temperature		-40 to +150	°C
Tstg	Storage Temperature		-40 to +150	°C
Mounting Torque	To terminals(M5)		3±15%	Nm
	To heatsink(M5)		5±15%	Nm
Weight	Approximate Weight	Module	145	g

Thermal Characteristics

Symbol	Item	Conditions	Values	Units
Rth(j-c)	Thermal Impedance, max.	Per Module	0.20	°C/W

Electrical Characteristics

Symbol	Item	Conditions	Values			Units
			Min.	Typ.	Max.	
VFM	Forward Voltage Drop, max.	T=25°C IF =150A		1.38	1.60	V
I _{RRM}	Repetitive Peak Reverse Current, max.	Tvj =25°C VRD=VRRM Tvj =150°C VRD=VRRM			0.5 5	mA mA

Performance Curves

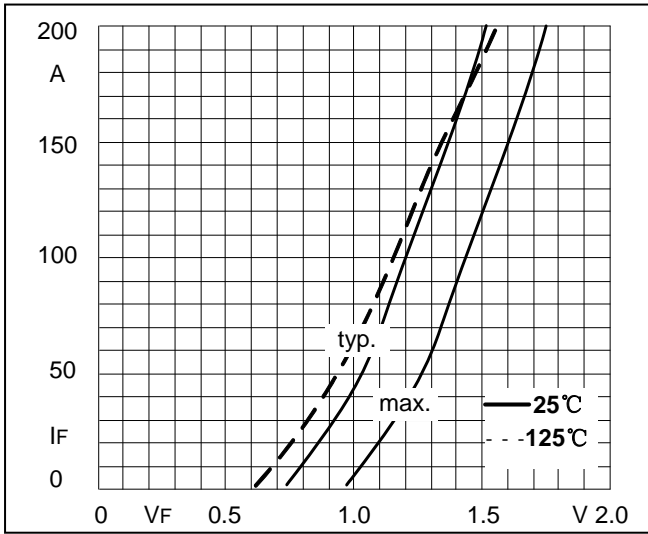

Fig1. Forward Characteristics

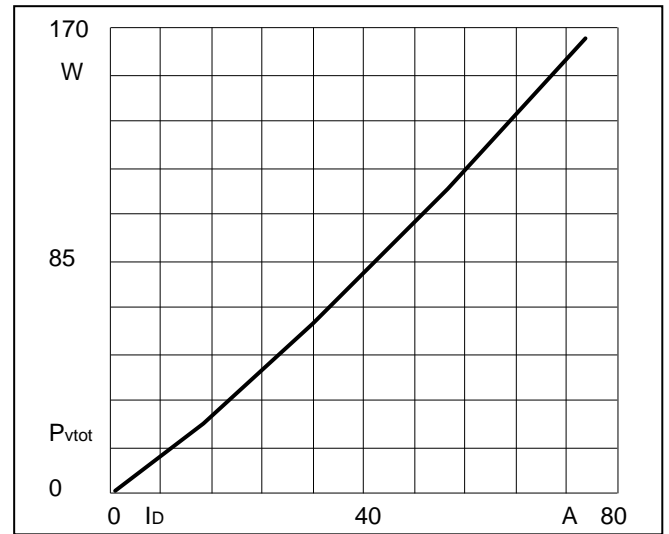

Fig2. Power dissipation

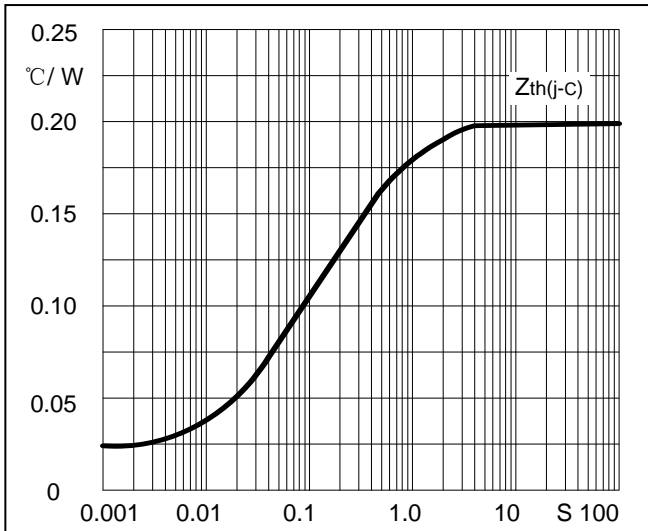

Fig3. Transient thermal impedance

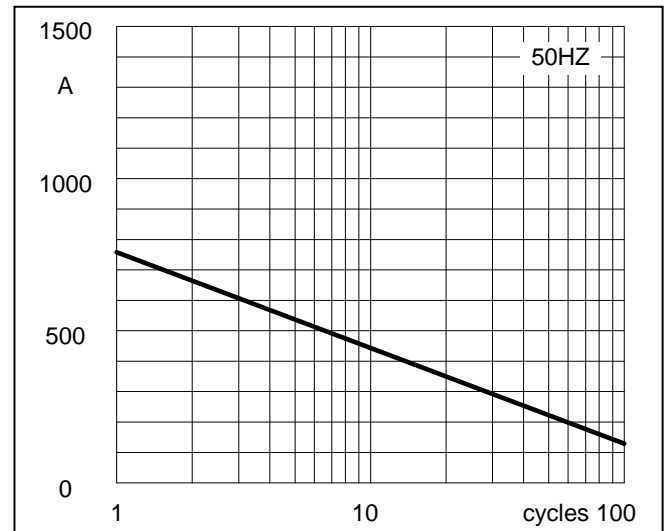

Fig4. Max Non-Repetitive Forward Surge Current

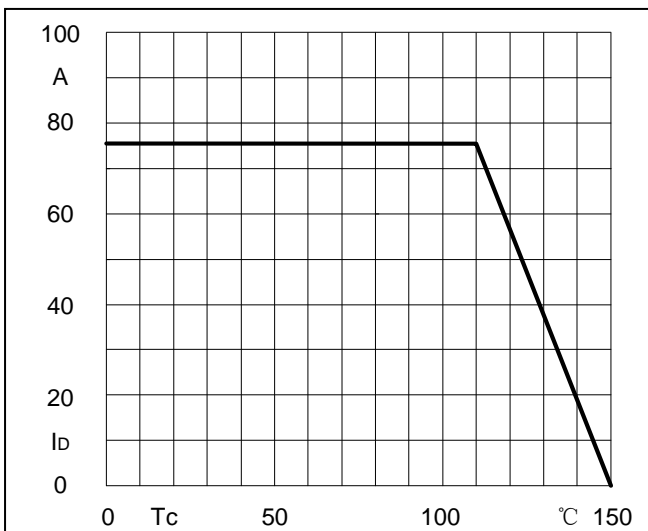
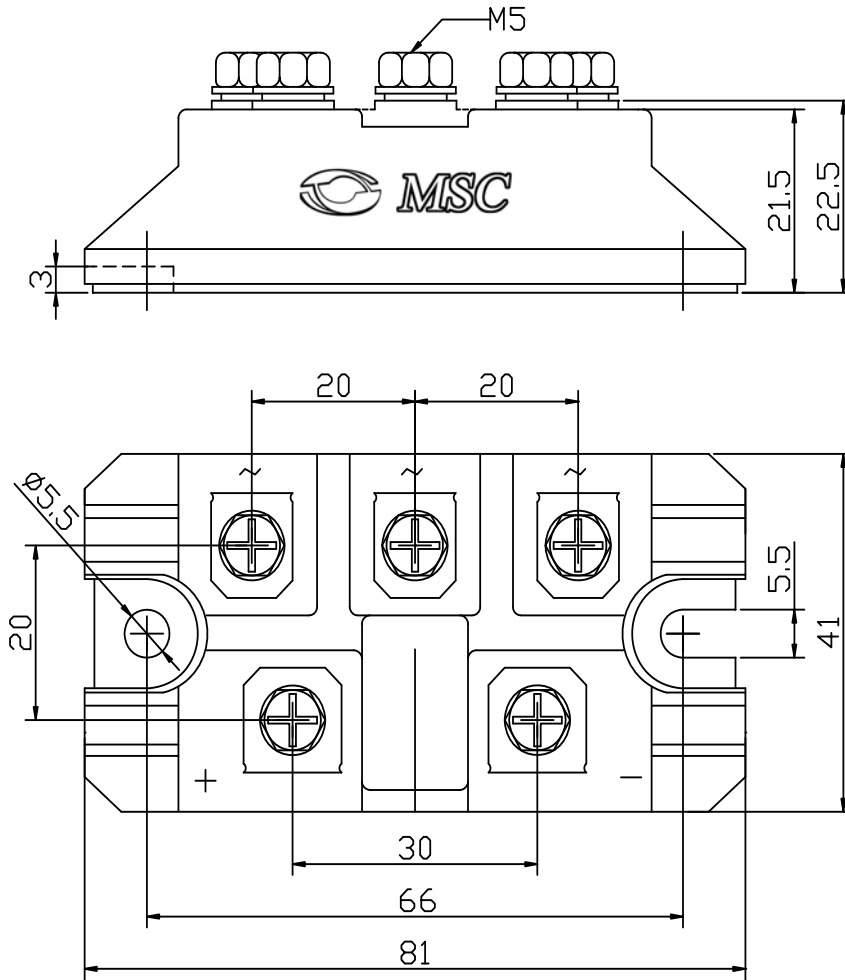

Fig5. Forward Current Derating Curve

Package Outline Information

CASE: M2-1



Dimensions in mm