

1N483B

FEATURES

- 1N483B AVAILABLE IN JAN, JANTX, AND JANTXV PER MIL-PRF-19500/118
- SWITCHING DIODE
- METALLURGICALLY BONDED
- HERMETICALLY SEALED
- DOUBLE PLUG CONSTRUCTION
- ALSO AVAILABLE AS 1N483 & 1N483A

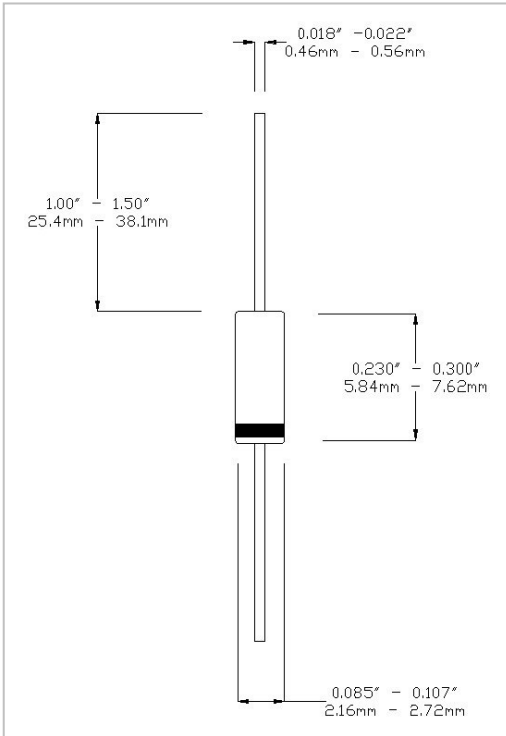

MAXIMUM RATINGS AT 25 °C

Operating Temperature:	-65°C to +175°C
Storage Temperature:	-65°C to +175°C
Surge Current, sine, 8.3mS:	2A
Total Power Dissipation, 25°C:	500mW
Power Derating Factor, 25°C:	3mW/°C
Max. Operating Current, 25°C:	200mA
Derating Factor:	1.2mA/°C above T _A = +25°C
Max. Operating Current, 150°C:	50mA
Derating Factor:	1.0mA/°C above T _A = +150°C
D.C. Reverse Voltage (VRWM):	70V

DESIGN DATA

Case: Hermetically sealed glass package per MIL-PRF-19500/118 DO-7 outline

Lead Material: Copper clad steel

Lead Finish: Tin/Lead

Thermal Impedance (Z_{θJX}): 70°C/W maximum

Marking: Blue body coat, black digits

Polarity: Cathode end is banded

DC ELECTRICAL CHARACTERISTICS

V _F				I _R			
Ambient (°C)	I _F mA	Min V	Max V	Ambient (°C)	V (dc)	Min μA	Max μA
25	100	0.8	1.0	25	70	-	0.025
-55	100	-	1.2	25	80	-	100
				150	70	-	5.0



WWW.MICROSEMI.COM

IRELAND - GORT ROAD, ENNIS, CO. CLARE

PHONE: +353 65 6840044
TOLL FREE: +186 62 702434
FAX: +353 65 6822298

U.S.A. DOMESTIC SALES CONTACT

PHONE: (617) 926 0404
TOLL FREE: 1 800 666 2999