

101654.100

1200 MHz Oscillator

Specifications

Parameter	Symbol	Min	Typical	Max	Unit	Notes
Center Frequency	F_0	-0.09	1200	0.09	MHz	$V_{TUNE} = 1.0V, 20^\circ C$
Absolute Pull Range	APR	30	n/a	n/a	ppm	$V_{TUNE} = 0.5V$ to $5.0V, -20^\circ C$ to $70^\circ C$
Tuning K		24	48	96	KHz/V	Average incremental sensitivity
Tuning $K_R = K_{max} / K_{min}$		n/a	3:01	4:01	unitless	
Temperature Stability		n/a	150	200	ppm _{P-P}	$V_{TUNE} = 1.0V, -20^\circ C$ to $70^\circ C$
Aging, 20 years		n/a	20	30	ppm	Absolute change from initial freq
Output Power		8	10	12	dBm	50 Ohm load, $-20^\circ C$ to $70^\circ C$
Harmonic Spurious		n/a	-30	-20	dBc	50 Ohm load, $-20^\circ C$ to $70^\circ C$
Non-harmonic Spurious		n/a	-80	n/a	dBc	50 Ohm load, $-20^\circ C$ to $70^\circ C$
SSB Phase Noise at 1 KHz			-100		dBc/Hz	
SSB Phase Noise at 10 KHz			-130		dBc/Hz	
SSB Phase Noise Floor			-174		dBc/Hz	
Vibration Sensitivity			0.5	1	ppb/G	per axis***STW resonator
Output Frequency Multiplier		n/a	1	n/a	unitless	
Oven warm-up power		n/a	n/a	n/a	W	from $-40^\circ C$
Oven warm-up time		n/a	n/a	n/a	sec	from $-40^\circ C$
V_{SUPPLY}		5	12	15	Volts	
I_{SUPPLY}		n/a	30	n/a	mA	50 Ohm load, $-20^\circ C$ to $70^\circ C$, w/o oven $V_S = 12V$

Typical Phase Noise Performance

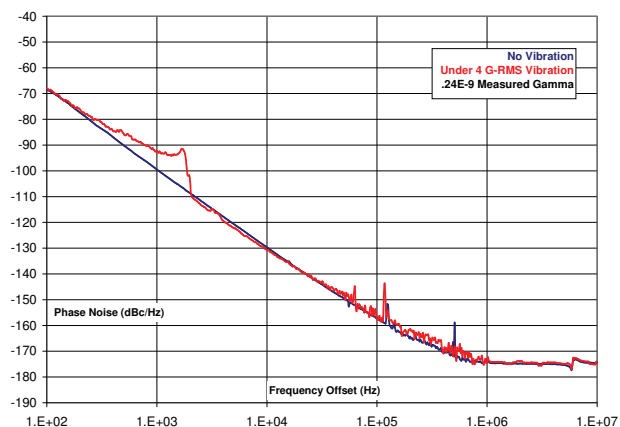

Micro-Oven Performance

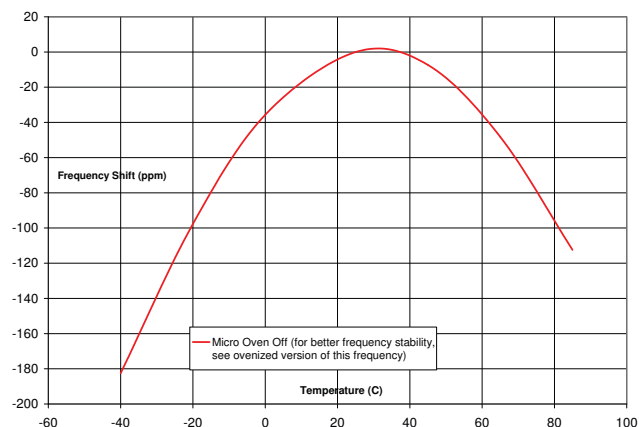

101654.100

1200 MHz Oscillator

Electrical Tuning

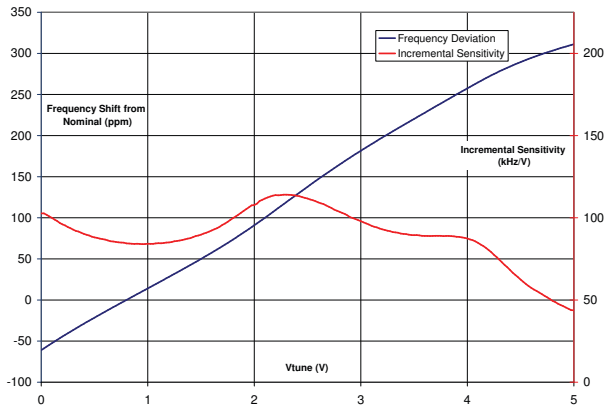

Package Outline

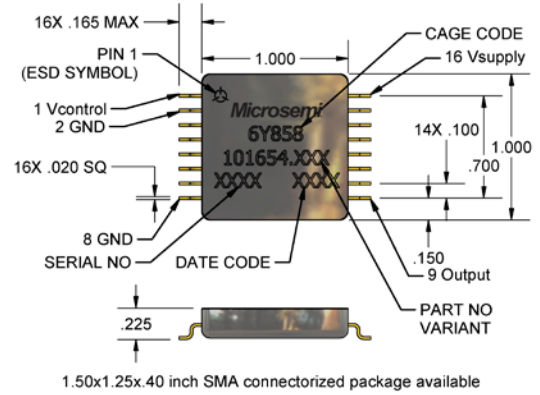

Typical Phase Noise Performance

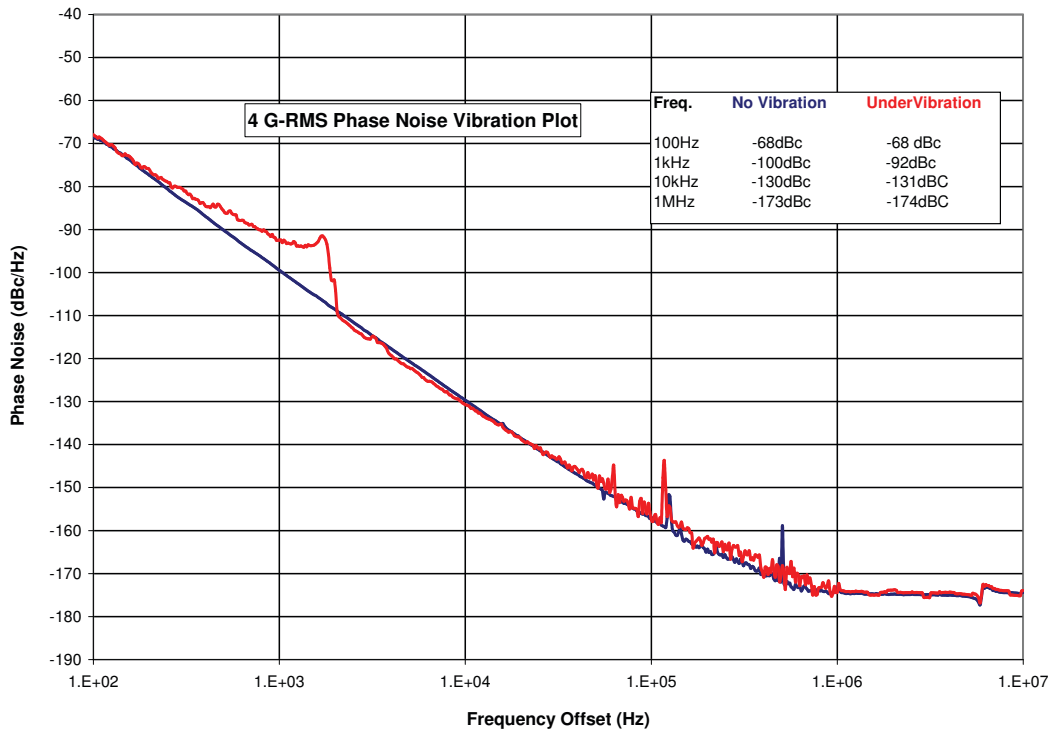

101654.100

1200 MHz Oscillator

Micro-Oven Performance (Patent Pending)

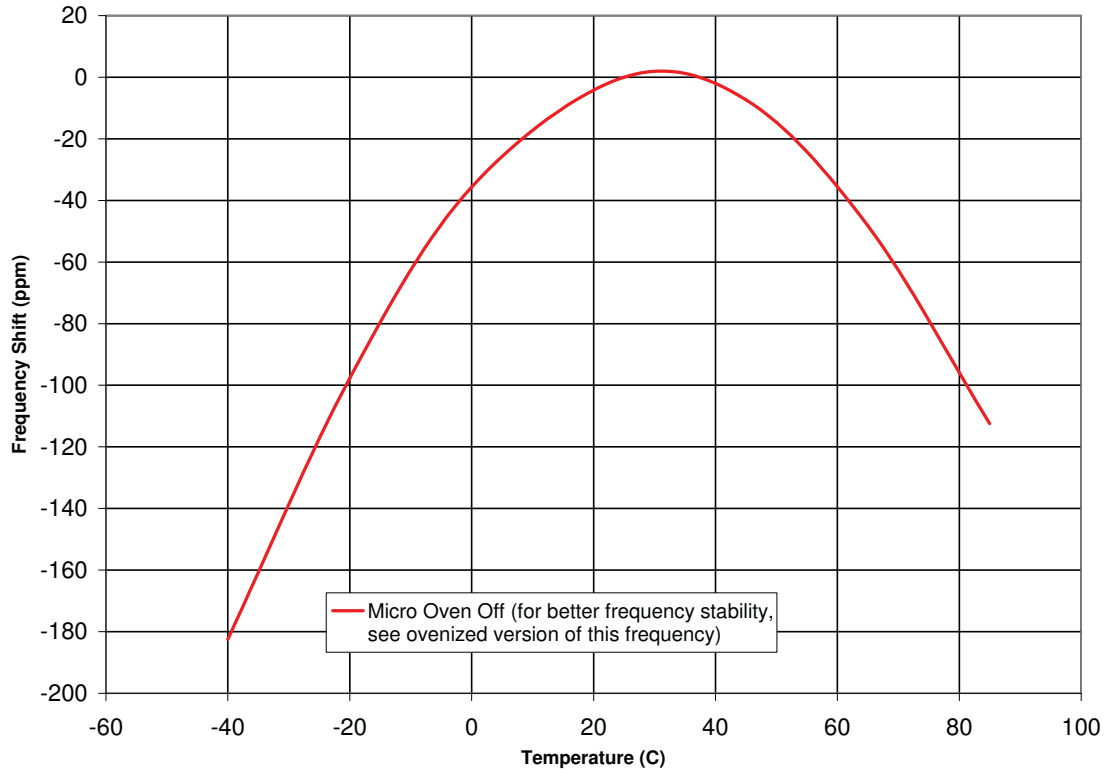

Frequency Shift and Incremental Sensitivity

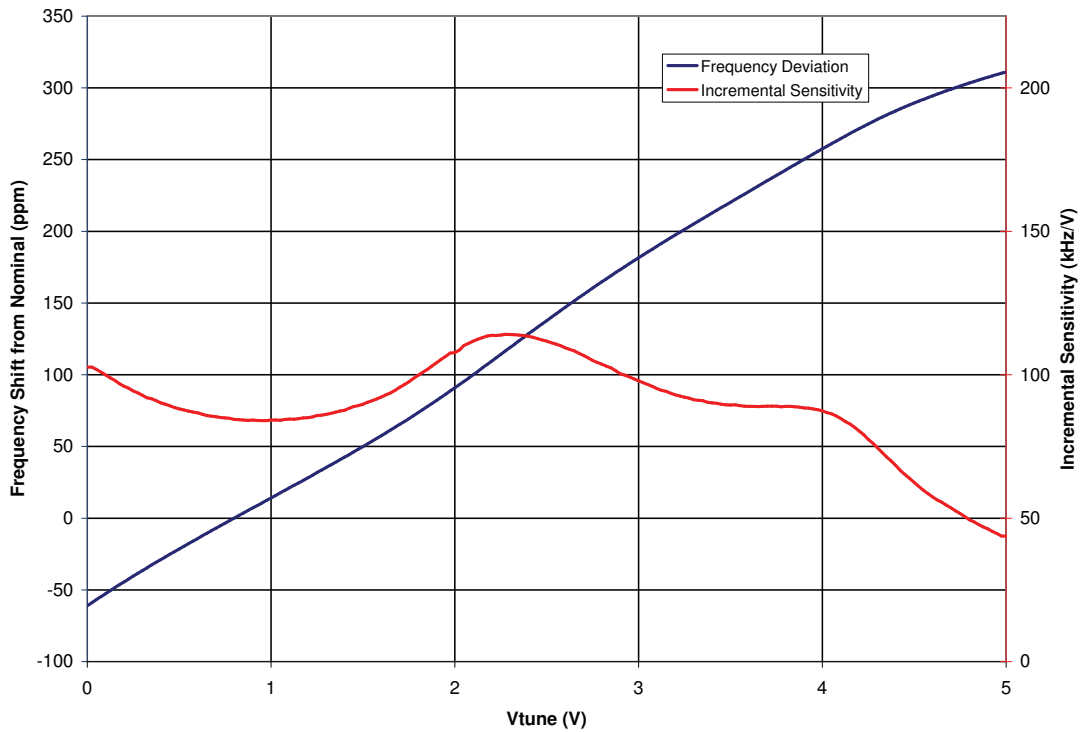

101654.100

1200 MHz Oscillator

Spectrum Output

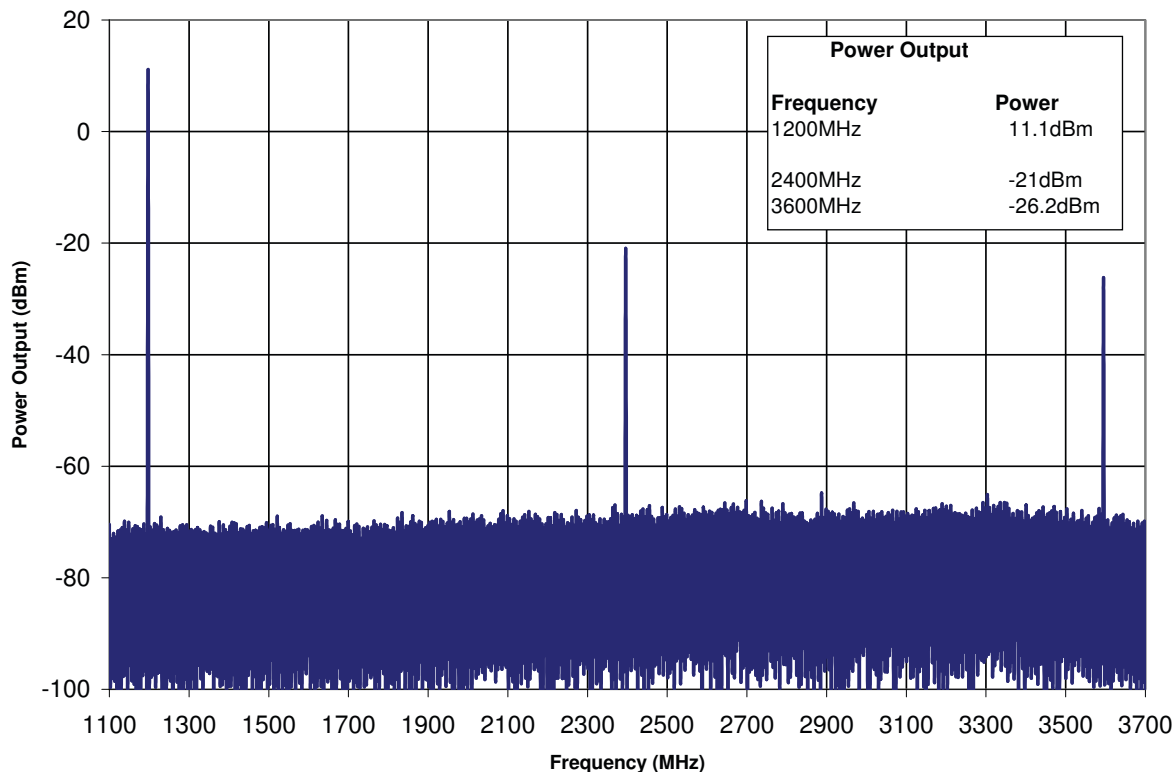

Microsemi Corporate Headquarters
 One Enterprise, Aliso Viejo, CA 92656 USA
 Within the USA: +1 (800) 713-4113
 Outside the USA: +1 (949) 380-6100
 Fax: +1 (949) 215-4996
 Email: sales.support@microsemi.com
 www.microsemi.com

Microsemi Corporation (Nasdaq: MSCC) offers a comprehensive portfolio of semiconductor and system solutions for aerospace & defense, communications, data center and industrial markets. Products include high-performance and radiation-hardened analog mixed-signal integrated circuits, FPGAs, SoCs and ASICs; power management products; timing and synchronization devices and precise time solutions, setting the world's standard for time; voice processing devices; RF solutions; discrete components; enterprise storage and communication solutions, security technologies and scalable anti-tamper products; Ethernet solutions; Power-over-Ethernet ICs and midspans; as well as custom design capabilities and services. Microsemi is headquartered in Aliso Viejo, California and has approximately 4,800 employees globally. Learn more at www.microsemi.com.

Microsemi makes no warranty, representation, or guarantee regarding the information contained herein or the suitability of its products and services for any particular purpose, nor does Microsemi assume any liability whatsoever arising out of the application or use of any product or circuit. The products sold hereunder and any other products sold by Microsemi have been subject to limited testing and should not be used in conjunction with mission-critical equipment or applications. Any performance specifications are believed to be reliable but are not verified, and Buyer must conduct and complete all performance and other testing of the products, alone and together with, or installed in, any end-products. Buyer shall not rely on any data and performance specifications or parameters provided by Microsemi. It is the Buyer's responsibility to independently determine suitability of any products and to test and verify the same. The information provided by Microsemi hereunder is provided "as is, where is" and with all faults, and the entire risk associated with such information is entirely with the Buyer. Microsemi does not grant, explicitly or implicitly, to any party any patent rights, licenses, or any other IP rights, whether with regard to such information itself or anything described by such information. Information provided in this document is proprietary to Microsemi, and Microsemi reserves the right to make any changes to the information in this document or to any products and services at any time without notice.