

THE DRAWINGS AND INFORMATION CONTAINED HEREIN ARE THE EXCLUSIVE PROPERTY OF ACTEL.
 THE INFORMATION, DRAWINGS AND DESIGN CONCEPTS CONTAINED HEREIN ARE CONFIDENTIAL/PROPRIETARY, SHALL
 BE MAINTAINED IN STRICT CONFIDENCE, AND SHALL NOT BE RELEASED TO ANY THIRD PARTY WITHOUT THE EXPRESS
 WRITTEN PERMISSION OF ACTEL.

ECN NO.	REV.	DESCRIPTION OF CHANGE	EFFECTIVE DATE	ORIGINATOR
2010201	0	New Release	3/19/2010	Erwin Q.

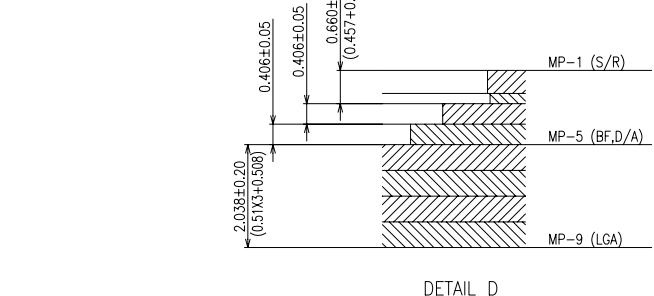
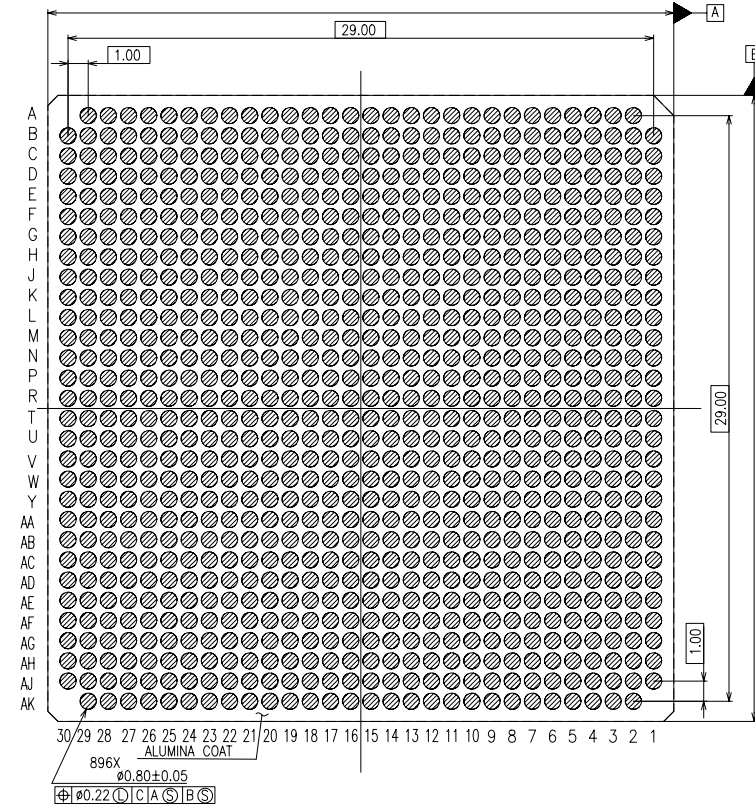
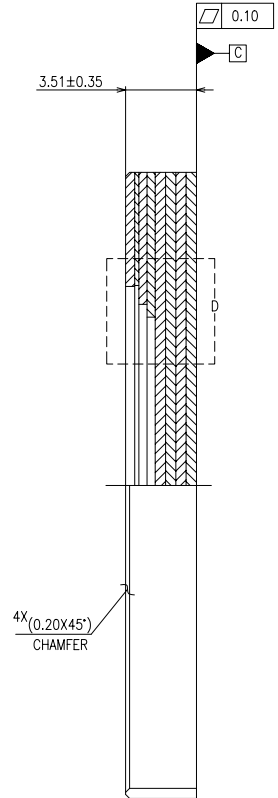
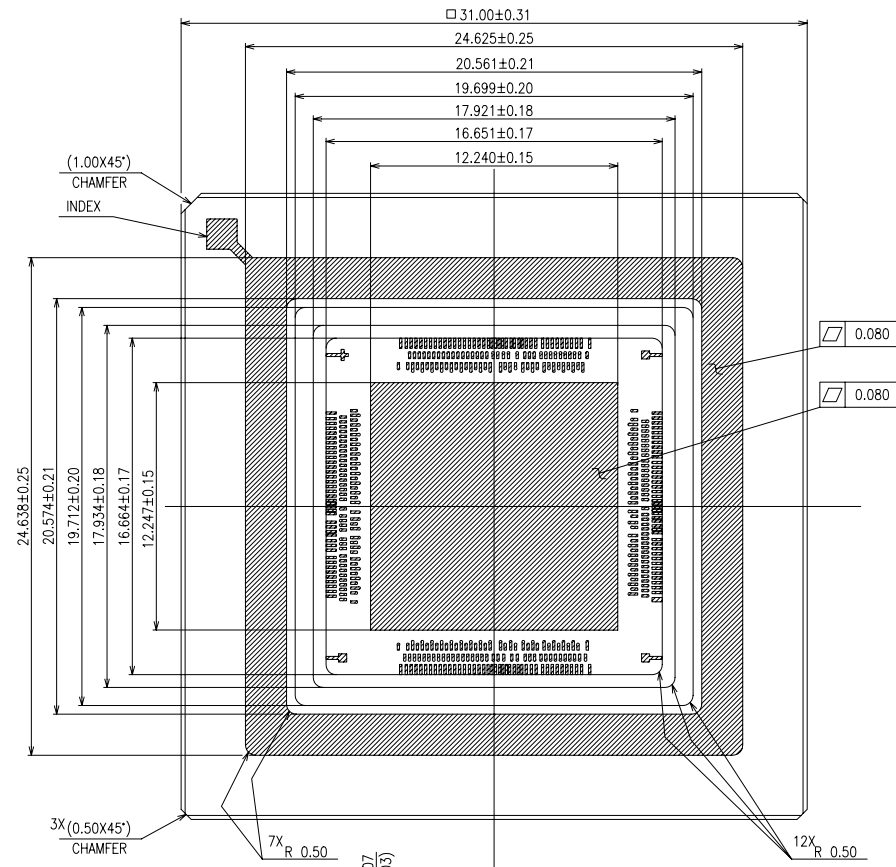

- NOTES:
1. PLATING:
 TOP : ELECTROLESS Ni 3.20~8.89 MICRON.
 TOP : ELECTROLESS Au 2.50 MICRON MIN.
 BOTTOM : ELECTROLESS Ni 3.20~8.89 MICRON.
 BOTTOM : ELECTROLESS Au 2.50 MICRON MIN.
 2. SEAL AREA TO BE METALLIZED.
 3. DIE ATTACH AREA TO BE METALLIZED.
 4. SEAL AREA, DIE ATTACH AREA AND FIDUCIAL MARK TO BE FLOATING FROM ANY PADS.
 5. BOND FINGERS CONNECTION SHOULD BE VENDOR'S OPTION.
 6. OPEN/SHORT CHECK TO BE PERFORMED ONLY TO LGA PADS.
 7. NO VISUAL INSPECTION IS REQUIRED FOR THE FIDUCIAL MARK AND BOND FINGERS AREA.

GENERAL TOLERANCE X.XX ± 0.20 Unless Otherwise Specified	PROJECTION	ACTEL CORPORATION 2061 STIERLIN COURT MOUNTAIN VIEW, CA 94043-4655			
	APPROVALS	DATE	TITLE CCGA896/CLGA896, 31 mm X 31 mm, 1.0 mm Pitch, 8-Layer 896 Column Pads, Ceramic Land Grid Array, Package Detail Drawing		
DIMENSIONS: Millimeters (mm)	CHECKED	VENDOR NAME: KYOCERA	ACTEL DWG. NUMBER 1-21-11877	REV 0	
	ENG'R ERWIN QUIOBO	3/19/2010	SIZE --	Actel Package Part Number YPKG-89CG-6566DC	VENDOR DWG. NUMBER KD-NB0167
	RELEASED				SCALE: NONE SHEET 1 OF 6

CONNECTION TABLE

function: SIGNAL

LGA No.	LGA No.	LGA No.	LGA No.	LGA No.	LGA No.	LGA No.	LGA No.	LGA No.	LGA No.	LGA No.	LGA No.	LGA No.	LGA No.	LGA No.	LGA No.	LGA No.	LGA No.	LGA No.	NC
A2	AA26	AC17	AE9	AF30	AH22	AK16	C4	D23	F11	H1	J18	L7	M25	P14	T2	U24	W15	OTHER	
A3	AB26	AC18	AE10	AG30	AH23	AK17	C5	D24	F12	J1	J19	M7	N25	R14	U2	V24	W16	D/A	
A4	AA28	AC19	AE11	AG3	AH24	AK18	C6	D25	F13	H2	J20	L9	M27	P15	T4	U26	W17	S/R	
A5	AB28	AC20	AE12	AH3	AH25	AK19	C7	D26	F14	J2	J21	M9	N27	P16	U4	V26	W18		
A6	AB1	AC21	AE13	AG5	AH26	AK20	C8	D27	F15	H4	J22	L11	M29	P17	T6	U28	W20		
A7	AC1	AC22	AE14	AG6	AH27	AK21	C9	E27	F16	J4	K22	M11	N29	R17	U6	V28	Y20		
A8	AB2	AC24	AE15	AG7	AH29	AK22	C10	D29	F17	H6	J24	L12	M30	P19	T8	V1	W22		
A9	AC2	AD24	AE16	AG8	AJ29	AK23	C11	E29	F18	J6	K24	L13	N30	R19	U8	W1	Y22		
A10	AB4	AC26	AE17	AG9	AH30	AK24	C12	D30	F19	H8	J26	L14	N3	P21	T10	V2	W24		
A11	AC4	AD26	AE18	AG10	AJ30	AK25	C13	E30	F20	J8	K26	L15	P3	R21	U10	W2	Y24		
A12	AB6	AC28	AE19	AG11	AJ3	AK26	C14	E3	F21	H9	J28	L16	N5	P23	T12	V4	W26		
A13	AC6	AD28	AE20	AG12	AJ4	AK27	C15	F3	F22	H10	K28	L17	P5	R23	U12	W4	Y26		
A14	AB8	AD1	AE21	AG13	AJ5	AK28	C16	E5	F23	H11	K1	L18	N7	P25	T14	V6	W28		
A15	AC8	AE1	AE22	AG14	AJ6	AK29	C17	F5	F24	H12	L1	L19	P7	R25	U14	W6	Y28		
A16	AB10	AD2	AE23	AG15	AJ7	B1	C18	E6	F25	H13	K2	L20	N9	P27	T17	V8	Y1		
A17	AB11	AE2	AE24	AG16	AJ8	C1	C19	E7	G25	H14	L2	M20	P9	R27	U17	W8	AA1		
A18	AB12	AD4	AE26	AG17	AJ9	B2	C20	E8	F27	H15	K4	L22	N11	P29	T19	V10	Y2		
A19	AB13	AE4	AF26	AG18	AJ10	C2	C21	E9	G27	H16	L4	M22	P11	R29	U19	W10	AA2		
A20	AB14	AD6	AE28	AG19	AJ11	B3	C22	E10	F29	H17	K6	L24	N13	P30	T21	V12	Y4		
A21	AB15	AE6	AF28	AG20	AJ12	B4	C23	E11	G29	H18	L6	M24	P13	R30	U21	W12	AA4		
A22	AB16	AD8	AF1	AG21	AJ13	B5	C24	E12	F30	H19	K8	L26	N14	R3	T23	V14	Y6		
A23	AB17	AD9	AG1	AG22	AJ14	B6	C25	E13	G30	H20	L8	M26	N15	T3	U23	V15	AA6		
A24	AB18	AD10	AF2	AG23	AJ15	B7	C26	E14	G3	H21	K10	L28	N16	R5	T25	V16	Y8		
A25	AB19	AD11	AG2	AG24	AJ16	B8	C27	E15	H3	H22	L10	M28	N17	T5	U25	V17	AA8		
A26	AB20	AD12	AF4	AG25	AJ17	B9	C28	E16	G5	H23	K11	M1	N18	R7	T27	V19	Y10		
A27	AB21	AD13	AG4	AG26	AJ18	B10	D28	E17	H5	J23	K12	N1	P18	T7	U27	W19	AA10		
A28	AB23	AD14	AF6	AG28	AJ19	B11	D1	E18	G7	H25	K13	M2	N20	R9	T29	V21	Y12		
A29	AC23	AD15	AF7	AH28	AJ20	B12	E1	E19	H7	J25	K14	N2	P20	T9	U29	W21	Y13		
AA3	AB25	AD16	AF8	AH1	AJ21	B13	D2	E20	G8	H27	K15	M4	N22	R11	T30	V23	Y14		
AB3	AC25	AD17	AF9	AJ1	AJ22	B14	E2	E21	G9	J27	K16	N4	P22	R13	U30	W23	Y15		
AA5	AB27	AD18	AF10	AH2	AJ23	B15	D4	E22	G10	H29	K17	M6	N24	R13	U3	V25	Y16		
AB5	AC27	AD19	AF11	AJ2	AJ24	B16	E4	E23	G11	J29	K18	N6	P24	T13	V3	W25	Y17		
AA7	AB29	AD20	AF12	AH4	AJ25	B17	D5	E24	G12	H30	K19	M8	N26	R15	U5	V27	Y18		
AB7	AC29	AD21	AF13	AH5	AJ26	B18	D6	E25	G13	J30	K20	N8	P26	T15	V5	W27	Y19		
AA9	AB30	AD22	AF14	AH6	AJ27	B19	D7	E26	G14	J3	K21	M10	N28	R16	U7	V29	Y21		
AB9	AC30	AD23	AF15	AH7	AJ28	B20	D8	F26	G15	K3	L21	N10	P28	T16	V7	W29	AA21		
AA11	AC3	AD25	AF16	AH8	AK2	B21	D9	E28	G16	J5	K23	M12	P1	R18	U9	V30	Y23		
AA12	AD3	AE25	AF17	AH9	AK3	B22	D10	F28	G17	K5	L23	N12	R1	T18	V9	W30	AA23		
AA13	AC5	AD27	AF18	AH10	AK4	B23	D11	F1	G18	J7	K25	M13	P2	R20	U11	W3	Y25		
AA14	AD5	AE27	AF19	AH11	AK5	B24	D12	G1	G19	K7	L25	M14	R2	T20	V11	Y3	AA25		
AA15	AC7	AD29	AF20	AH12	AK6	B25	D13	F2	G20	J9	K27	M15	P4	R22	U13	W5	Y27		
AA16	AD7	AE29	AF21	AH13	AK7	B26	D14	G2	G21	K9	L27	M16	R4	T22	V13	Y5	AA27		
AA17	AC9	AD30	AF22	AH14	AK8	B27	D15	F4	G22	J10	K29	M17	P6	R24	U15	W7	Y29		
AA18	AC10	AE30	AF23	AH15	AK9	B28	D16	G4	G23	J11	L29	M18	R6	T24	U16	Y7	AA29		
AA19	AC11	AE3	AF24	AH16	AK10	B29	D17	F6	G24	J12	K30	M19	P8	R26	U18	W9	Y30		
AA20	AC12	AF3	AF25	AH17	AK11	C29	D18	G6	H24	J13	L30	N19	R8	T26	V18	Y9	AA30		
AA22	AC13	AE5	AF27	AH18	AK12	B30	D19	F7	G26	J14	L3	M21	P10	R28	U20	W11			
AB22	AC14	AF5	AG27	AH19	AK13	C30	D20	F8	H26	J15	M3	N21	R10	T28	V20	Y11			
AA24	AC15	AE7	AF29	AH20	AK14	C3	D21	F9	G28	J16	L5	M23	P12	T1	U22	W13			
AB24	AC16	AE8	AG29	AH21	AK15	D3	D22	F10	H28	J17	M5	N23	R12	U1	V22	W14			

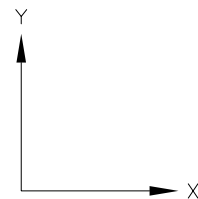

SIZE --	ACTEL DWG. NUMBER 1-21-11877	REV 0
	VENDOR DWG. NUMBER KD-NB0167	REV 0
SCALE: None		SHEET 2 OF 6

F

F

E

E

D

D

C

C

B

B

A

A

1 2 3 4 5 6 7 8 9 10 11 12 13 14 15 16 17 18 19 20 21 22 23 24 25 26 27 28 29 30

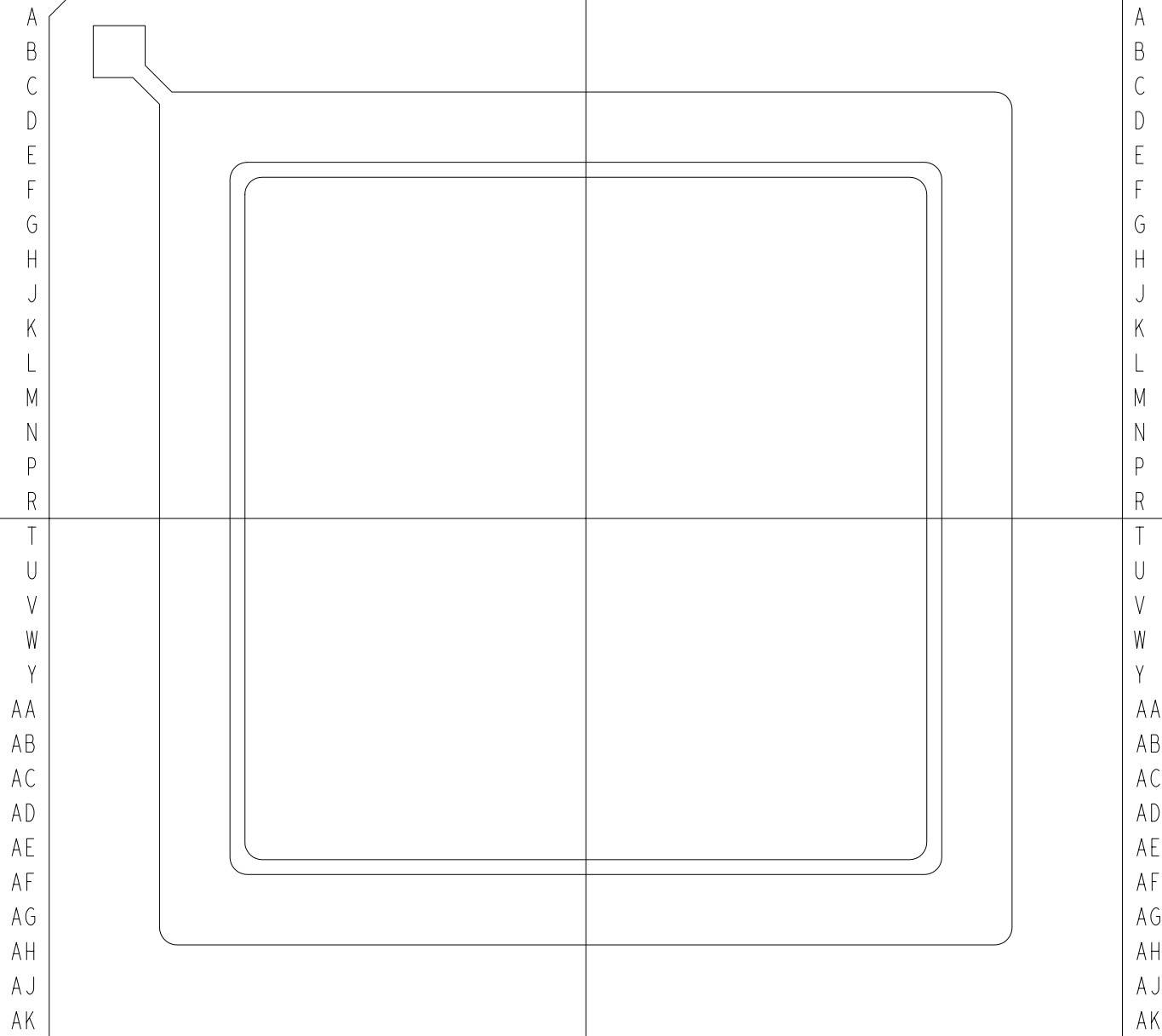

1 2 3 4 5 6 7 8 9 10 11 12 13 14 15 16 17 18 19 20 21 22 23 24 25 26 27 28 29 30

MP-1
(S/R)

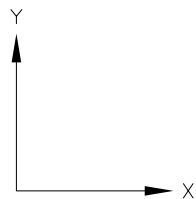

SIZE --	ACTEL DWG. NUMBER 1-21-11877	REV 0
	VENDOR DWG. NUMBER KD-NB0167	REV 0
SCALE: None		SHEET 3 OF 6

F

F

E

E

D

D

C

C

B

B

A

A

1 2 3 4 5 6 7 8 9 10 11 12 13 14 15 16 17 18 19 20 21 22 23 24 25 26 27 28 29 30

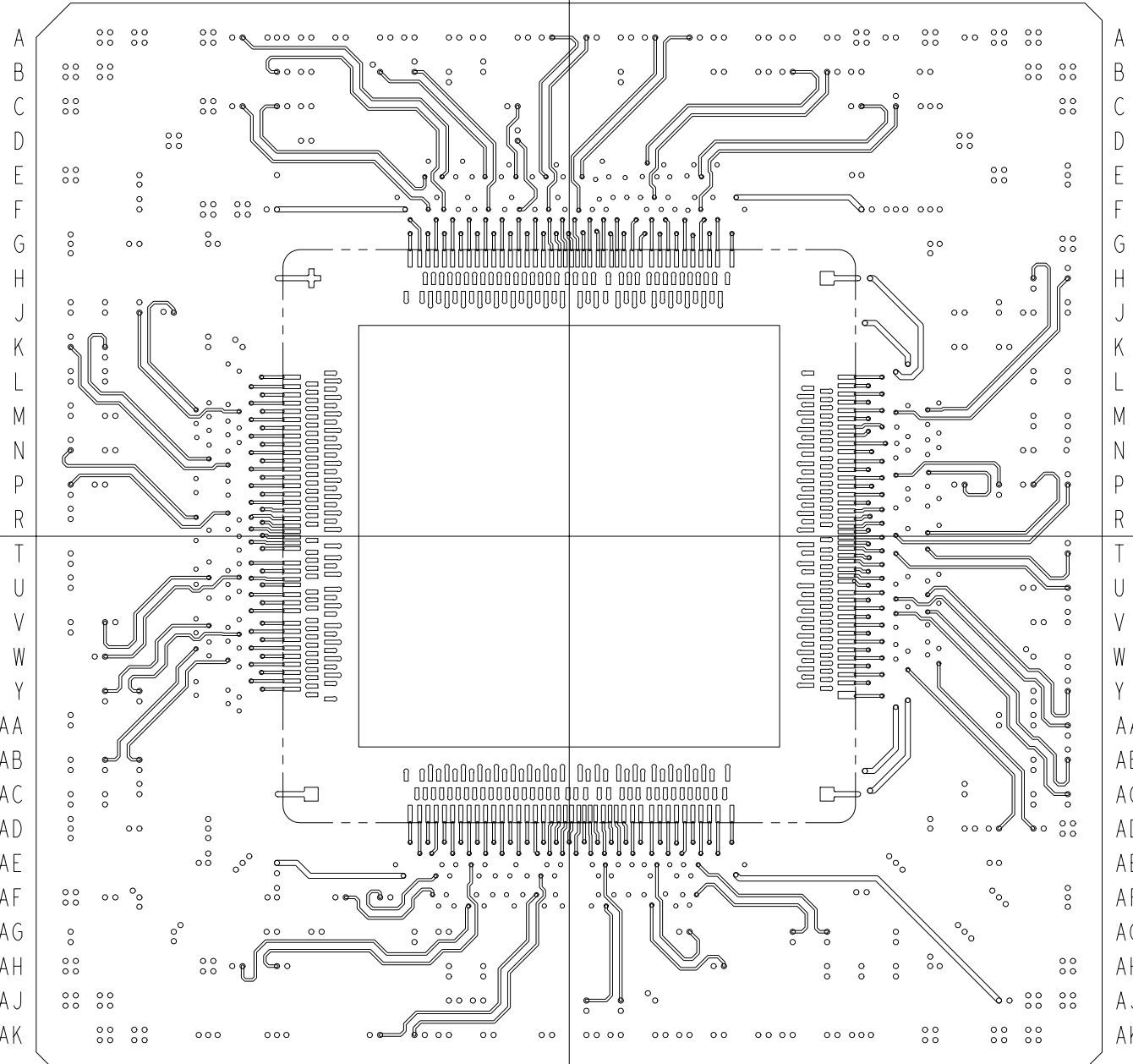

1 2 3 4 5 6 7 8 9 10 11 12 13 14 15 16 17 18 19 20 21 22 23 24 25 26 27 28 29 30

MP-5
 (BF,D/A)

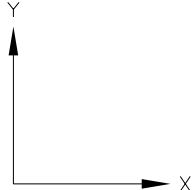

SIZE --	ACTEL DWG. NUMBER 1-21-11877	REV 0
	VENDOR DWG. NUMBER KD-NB0167	REV 0
SCALE: None		SHEET 4 OF 6

F

F

E

E

D

D

C

C

B

B

A

A

1 2 3 4 5 6 7 8 9 10 11 12 13 14 15 16 17 18 19 20 21 22 23 24 25 26 27 28 29 30

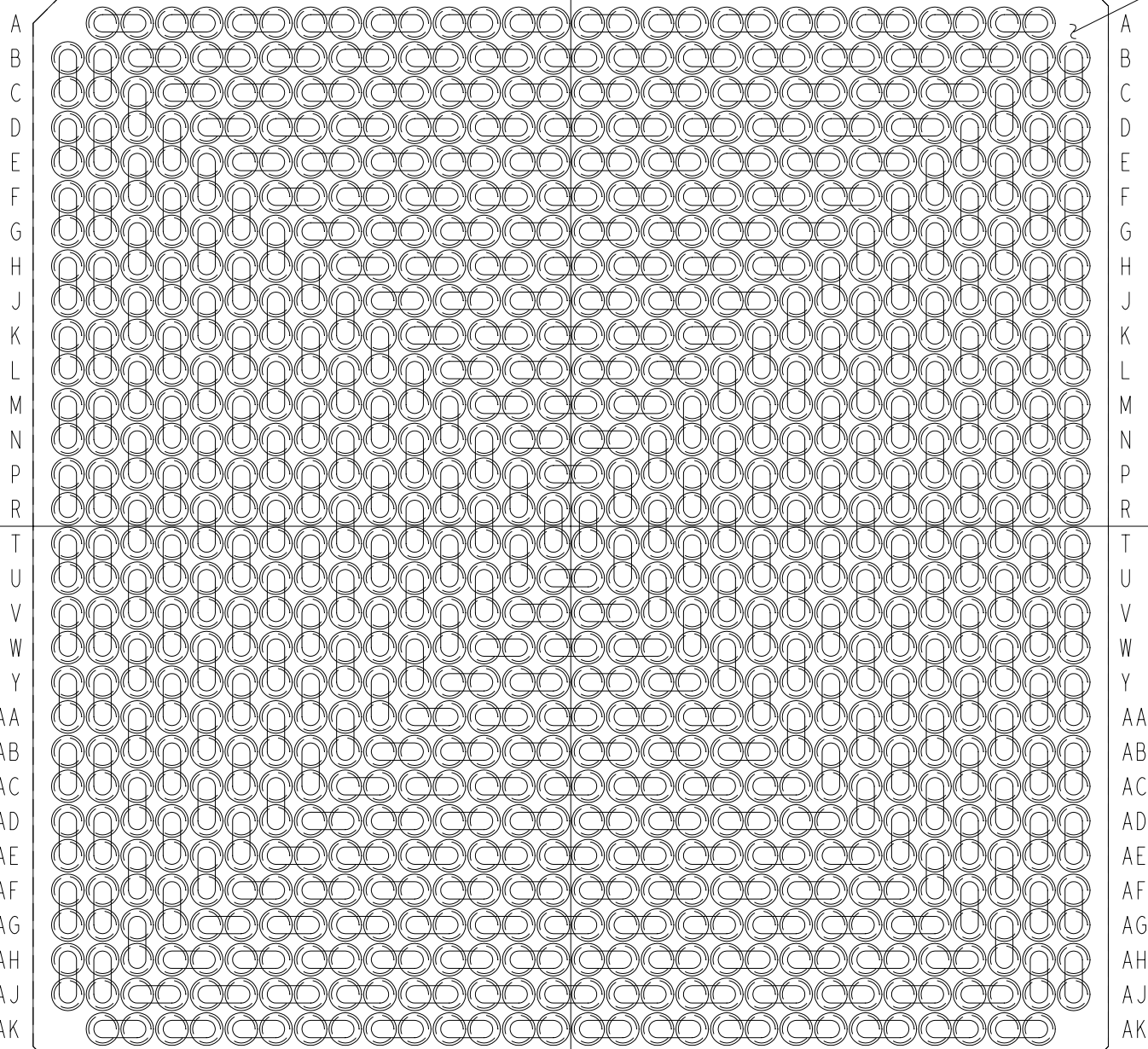

ALUMINA COAT

MP-9
(LGA)
(TOP VIEW)

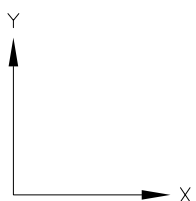

SIZE --	ACTEL DWG. NUMBER 1-21-11877	REV 0
	VENDOR DWG. NUMBER KD-NA0167	REV 0
SCALE: None		SHEET 5 OF 6

F

F

E

E

D

D

C

C

B

B

A

A

1 2 3 4 5 6 7 8 9 10 11 12 13 14 15 16 17 18 19 20 21 22 23 24 25 26 27 28 29 30

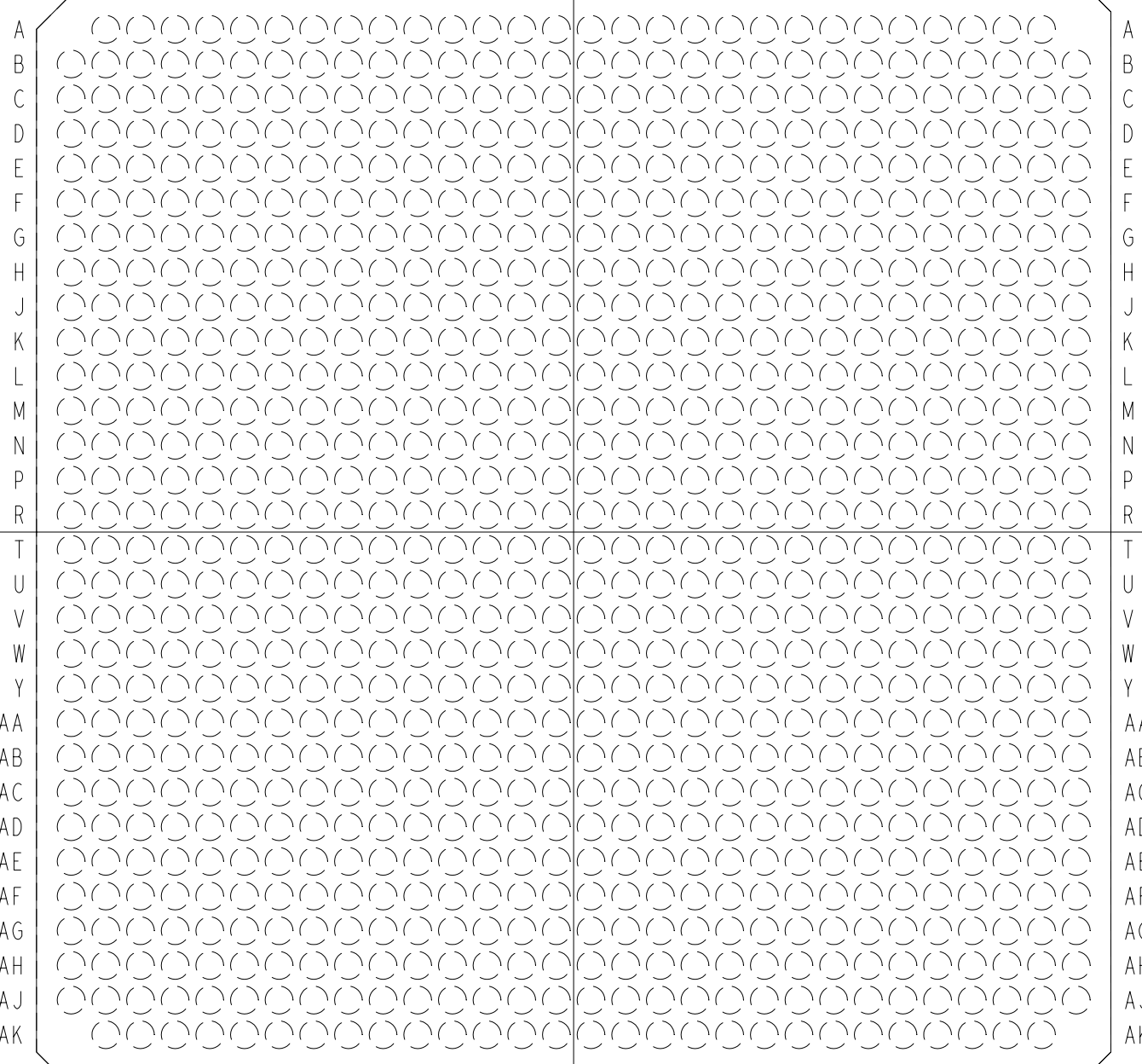

ALUMINA COAT
 (MP-9)
 (TOP VIEW)

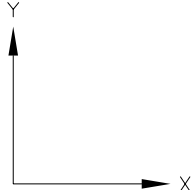

SIZE --	ACTEL DWG. NUMBER 1-21-11877	REV 0
	VENDOR DWG. NUMBER KD-NB0167	REV 0
SCALE: None		SHEET 6 OF 6