



Total Ionizing Dose Test Report

No. 13T-RTAX2000S-CQ352-D68N61

February 6, 2013

Table of Contents

I. Summary Table.....	3
II. Total Ionizing Dose (TID) Testing.....	3
A. Device-Under-Test (DUT) and Irradiation Parameters	3
B. Test Method	4
C. Design and Parametric Measurements.....	5
III. Test Results	6
A. Functionality	6
B. Power Supply Current (ICCA and ICCI).....	6
C. Single-Ended Input Logic Threshold (VIL/VIH).....	10
D. Differential Input (LVPECL) Threshold Voltage (VIL/VIH)	11
E. Output-Drive Voltage (VOL/VOH)	12
F. Propagation Delay.....	13
G. Transition Characteristics.....	15
Appendix A: DUT Bias	27
Appendix B: DUT Design Schematics and Verilog Files	29

TOTAL IONIZING DOSE TEST REPORT

No. 13T-RTAX2000S-CQ352-D68N61

February 6, 2013

CK Huang and J.J. Wang

(408) 643-6136, (408) 643-6302

chang-kai.huang@microsemi.com, jih-jong.wang@microsemi.com

I. Summary Table

Parameter	Tolerance
1. Gross Functionality	Passed 300 krad (SiO ₂)
2. Power Supply Current (ICCA/ICCI)	Passed 300 krad (SiO ₂)
3. Input Threshold (VTIL/VIH)	Passed 300 krad (SiO ₂)
4. Output Drive (VOL/VOH)	Passed 300 krad (SiO ₂)
5. Propagation Delay	Passed 300 krad (SiO ₂) for 10% degradation criterion
6. Transition Characteristics	Passed 300 krad (SiO ₂)

II. Total Ionizing Dose (TID) Testing

This testing is designed on the base of an extensive database (see TID data of antifuse-based FPGAs at <http://www.klabs.org> and <http://www.microsemi.com/soc>) accumulated from the TID testing of many generations of antifuse-based FPGAs.

A. Device-Under-Test (DUT) and Irradiation Parameters

Table 1 lists the DUT and irradiation parameters. During irradiation, each input and most of the output is grounded through a 1 MΩ resistor; during annealing, each input or output is tied to the ground or VCCI with a 2.7 kΩ resistor. Appendix A contains the schematics of the irradiation-bias circuit.

Table 1 DUT and Irradiation Parameters

Part Number	RTAX2000S
Package	CQFP352
Foundry	United Microelectronics Corp.
Technology	0.15 μm CMOS
DUT Design	TOP_AX2000S_TID
Die Lot Number	D68N61
Quantity Tested	6
Serial Number	300 krad(SiO ₂): 13129, 13132, 13134 200 krad(SiO ₂): 13137, 13148, 13150
Radiation Facility	Defense Microelectronics Activity
Radiation Source	Co-60
Dose Rate (±5%)	7.5 krad(SiO ₂)/min
Irradiation Temperature	Room
Irradiation and Measurement Bias (VCCI/VCCA)	Static at 3.3 V/1.5 V

B. Test Method

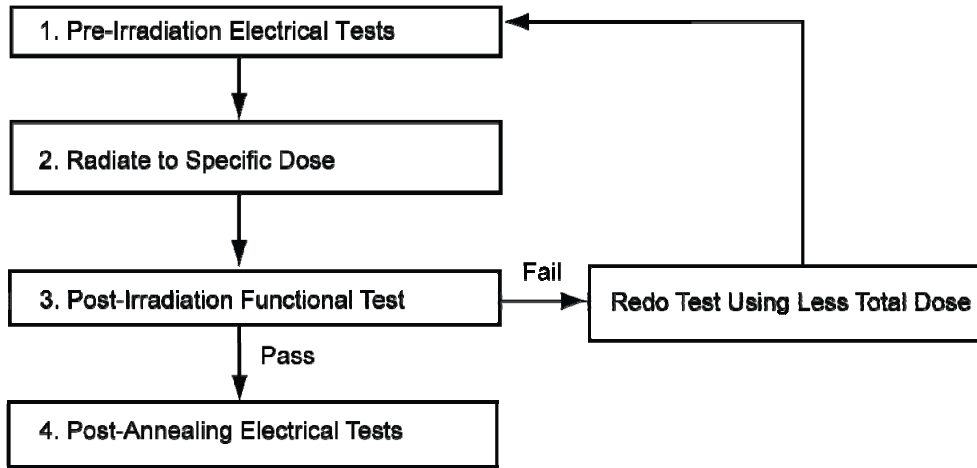

Figure 1 Parametric Test Flow Chart

The test method generally follows the guidelines in the military standard TM1019.8. Figure 1 is the flow chart describing the steps for functional and parametric tests, irradiation, and post-irradiation annealing.

The accelerated aging, or rebound test mentioned in TM1019.8 is unnecessary because there is no adverse time-dependent effect (TDE) in Microsemi products manufactured by deep sub-micron CMOS technologies. Elevated temperature annealing basically reduces the effects originating from radiation-induced leakage currents. As indicated by test data in the following sections, the predominant radiation effects in RTAX2000S are due to radiation-induced leakage currents.

Room temperature annealing is performed in this test; the duration is approximately 12 days.

C. Design and Parametric Measurements

The DUT uses a high utilization, generic design (TOP_AX2000S_TID) to evaluate total dose effects for typical space applications. Appendix B contains the schematics and Verilog files of this design.

Table 2 lists measured electrical parameters and the corresponding logic design. The functionality is measured on the output pin (O_BS) of a combinational buffer-string with 14,000 buffers, output pins (O_ANDP_CLKF, O_ORP_CLKF, O_FF_CLKF, O_ANDC_CLKF, O_ORC_CLKF, O_ANDP_CLKG, O_ORP_CLKG, O_FF_CLKG, O_ANDC_CLKG, O_ORC_CLKG, O_ANDP_CLKH, O_ORP_CLKH, O_FF_CLKH, O_ANDC_CLKH, O_ORC_CLKH, O_ANDP_HCLKA, O_ORP_HCLKA, O_FF_HCLKA, O_ANDC_HCLKA, and O_ORC_HCLKA) of four (4) shift registers with 10,728 bits total, and half of the output pins (OUTX0, OUTX1, OUTX2, OUTX3, OUTX4, OUTX5, OUTX6 and OUTX7) of the embedded RAM configured as 16K×16.

ICC is measured on the power supply of the logic-array (ICCA) and I/O (ICCI) respectively. The input logic threshold (VIL/VIH) is measured on single-ended inputs EN8, DA, IO_I1, IO_I2, IO_I3, IO_I4, IO_I5 and IO_I6, and also on differential inputs DIO_I1P, DIO_I2P, DIO_I3P, DIO_I4P, DIO_I5P, DIO_I6P and DIO_I7P. The differential inputs are configured as LVPECL instead of LVDS because LVPECL, using 3.3 VDC, is worse than LVDS, which uses 2.5 VDC. During the measurement on the differential inputs, the N (negative) side of the differential pair is biased at 1.8 V. The output-drive voltage (VOL/VOH) is measured on QA0 and YQ0. The propagation delay is measured on the output (O_BS) of the buffer string; the definition is the time delay from the triggering edge at the CLOCK input to the switching edge at the output O_BS. Both the delays of low-to-high and high-to-low output transitions are measured; the reported delay is the average of these two measurements. The transition characteristics, measured on the output O_BS, are shown as oscilloscope captures.

Table 2 Logic Design for Parametric Measurements

Parameters	Logic Design
1. Functionality	All key logic functions (O_BS, O_ANDP_CLKF, O_ORP_CLKF, O_FF_CLKF, O_ANDC_CLKF, O_ORC_CLKF, O_ANDP_CLKG, O_ORP_CLKG, O_FF_CLKG, O_ANDC_CLKG, O_ORC_CLKG, O_ANDP_CLKH, O_ORP_CLKH, O_FF_CLKH, O_ANDC_CLKH, O_ORC_CLKH, O_ANDP_HCLKA, O_ORP_HCLKA, O_FF_HCLKA, O_ANDC_HCLKA, and O_ORC_HCLKA), and outputs of embedded RAM (OUTX0, OUTX1, OUTX2, OUTX3, OUTX4, OUTX5, OUTX6 and OUTX7)
2. ICC (ICCA/ICCI)	DUT power supply
3. Input Threshold (VIL/VIH)	Single ended inputs (EN8/YQ0, DA/QA0, IO_I1/IO_O1, IO_I2/IO_O2, IO_I3/IO_O3, IO_I4/IO_O4, IO_I5/IO_O5, IO_I6/IO_O6), and differential inputs (DIO_I1P/DIO_O1, DIO_I2P/DIO_O2, DIO_I3P/DIO_O3, DIO_I4P/DIO_O4, DIO_I5P/DIO_O5, DIO_I6P/DIO_O6, DIO_I7P/DIO_O7)
4. Output Drive (VOL/VOH)	Output buffer (EN8/YQ0, DA/QA0)
5. Propagation Delay	String of buffers (CLOCK to O_BS)
6. Transition Characteristic	String of buffers output (O_BS)

III. Test Results

A. Functionality

Every DUT passed the pre-irradiation and post-annealing functional tests. The as-irradiated DUT is functionally tested on the output (O_FF_HCLKA) of the largest shift register.

B. Power Supply Current (ICCA and ICCI)

Figure 2 through Figure 7 plot the influx standby ICCA and ICCI versus total dose for each DUT. The post-annealing ICC for four different bit patterns, all '0', all '1', checkerboard and inverted-checkerboard, in the RAM are basically the same.

In compliance with TM1019.8 subsection 3.11.2.c, the post-irradiation-parametric limit (PIPL) for the post-annealing ICCI in this test is defined as the addition of highest ICCI, ICCDA and ICCDIFFA values in Table 2-4 of the *RTAX-S/SL and RTAX-DSP Radiation-Tolerant FPGAs* datasheet:

http://www.microsemi.com/soc/documents/RTAXS_DS.pdf

For ICCA, the PIPL is 500 mA; the PIPL of ICCI equals to $35 + 10 + 3.13 \times 7 = 66.91$ (mA). Note that there are 7 pairs of differential LVPECL inputs in each DUT.

Table 3 summarizes the pre-irradiation, post-irradiation right after irradiation and before anneal, and post-annealing ICCA and ICCI data.

Table 3 Pre-irradiation, Post Irradiation and Post-Annealing ICC

DUT	Total Dose	ICCA (mA)			ICCI (mA)		
		Pre-irrad	Post-irrad	Post-ann	Pre-irrad	Post-irrad	Post-ann
13129	300 krad	3	80	8	27	148	61
13132	300 krad	5	116	12	26	128	56
13134	300 krad	11	159	23	26	137	52
13137	200 krad	11	14	9	26	56	34
13148	200 krad	5	8	5	26	53	35
13150	200 krad	11	15	9	26	51	36

Based on these PIPL, post-annealed DUT passes both the ICCA and ICCI spec for 300 krad (SiO2).

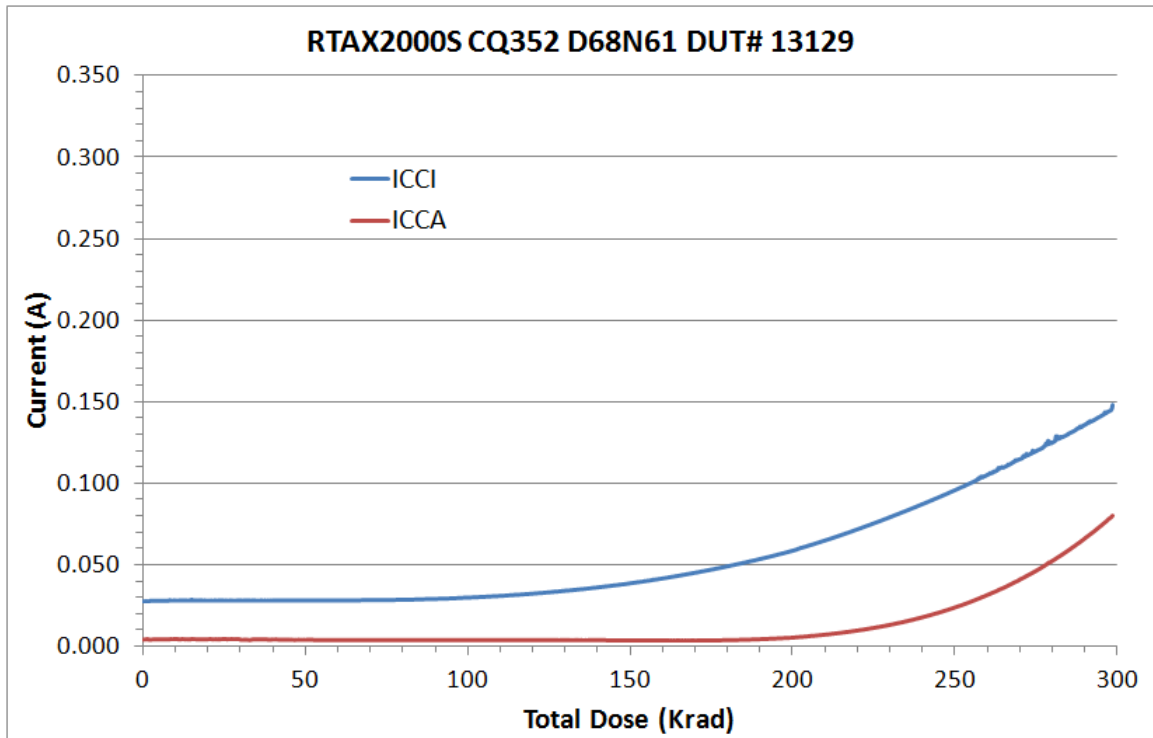

Figure 2 DUT 13129 Influx ICCA and ICCI

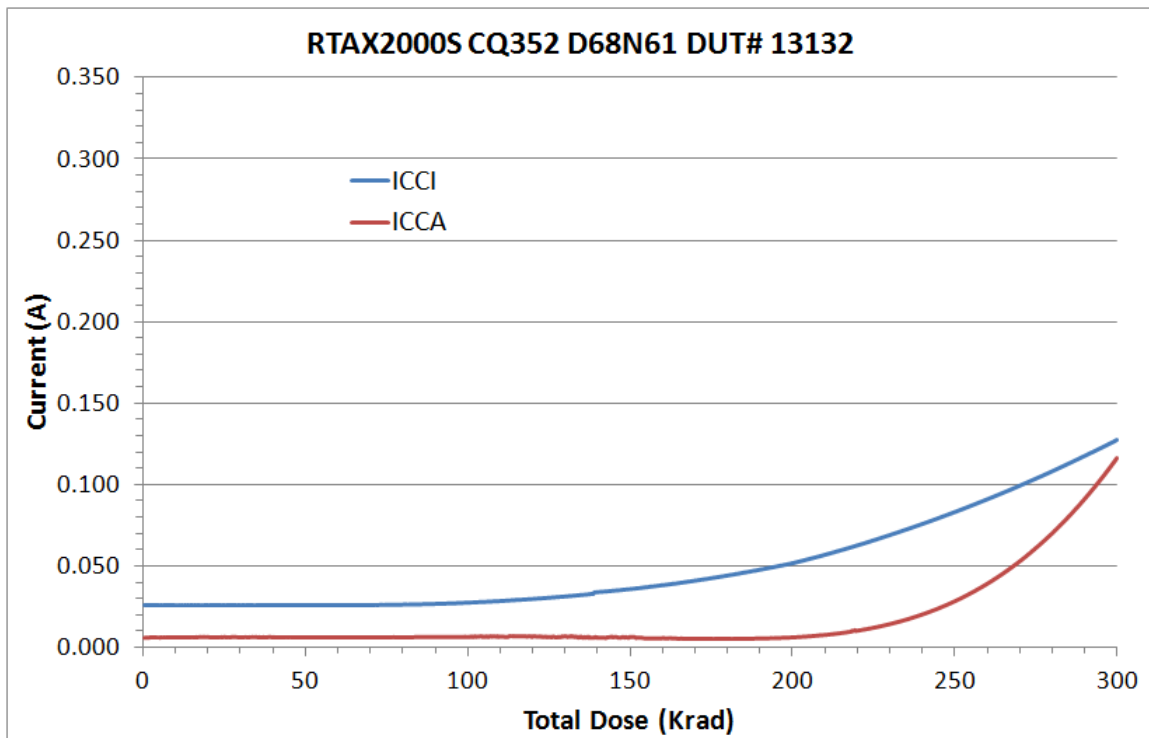

Figure 3 DUT 13132 Influx ICCA and ICCI

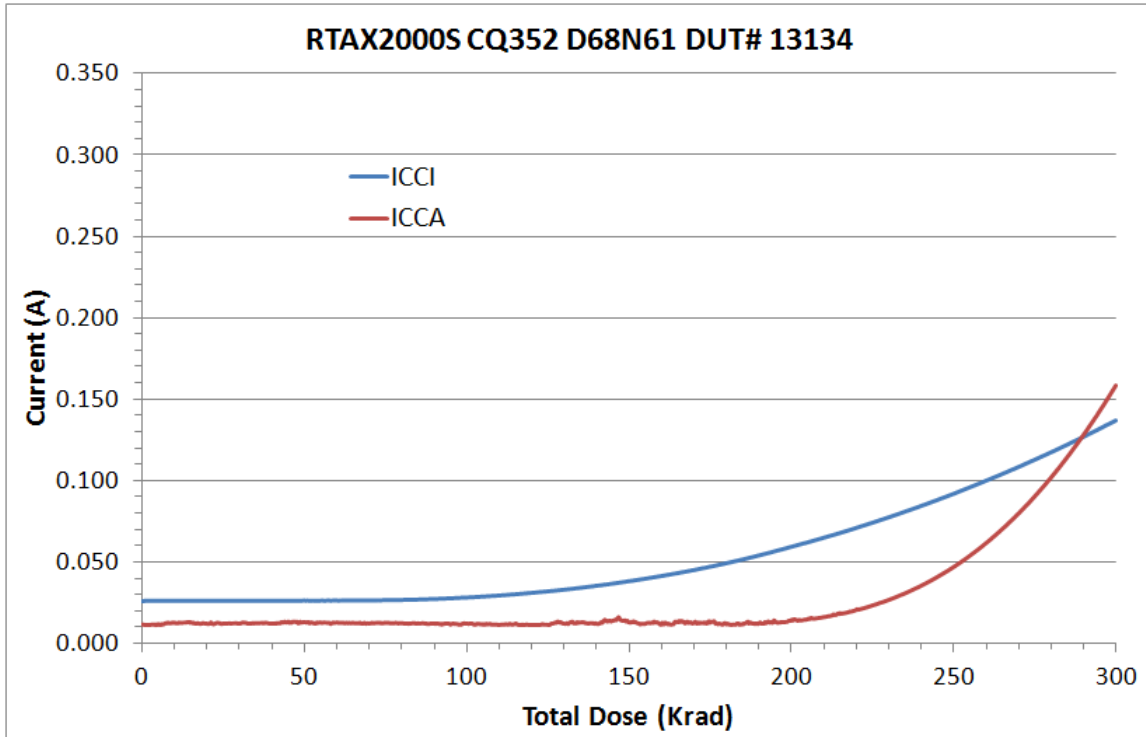

Figure 4 DUT 13134 Influx ICCA and ICCI

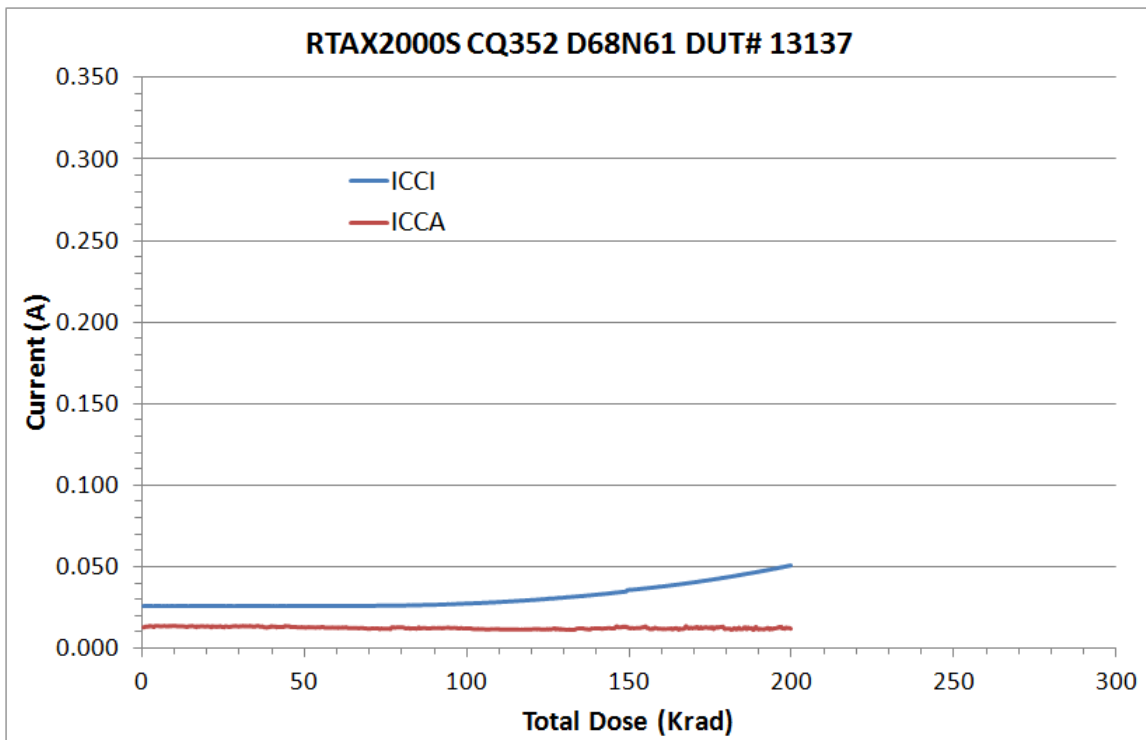

Figure 5 DUT 13137 Influx ICCA and ICCI

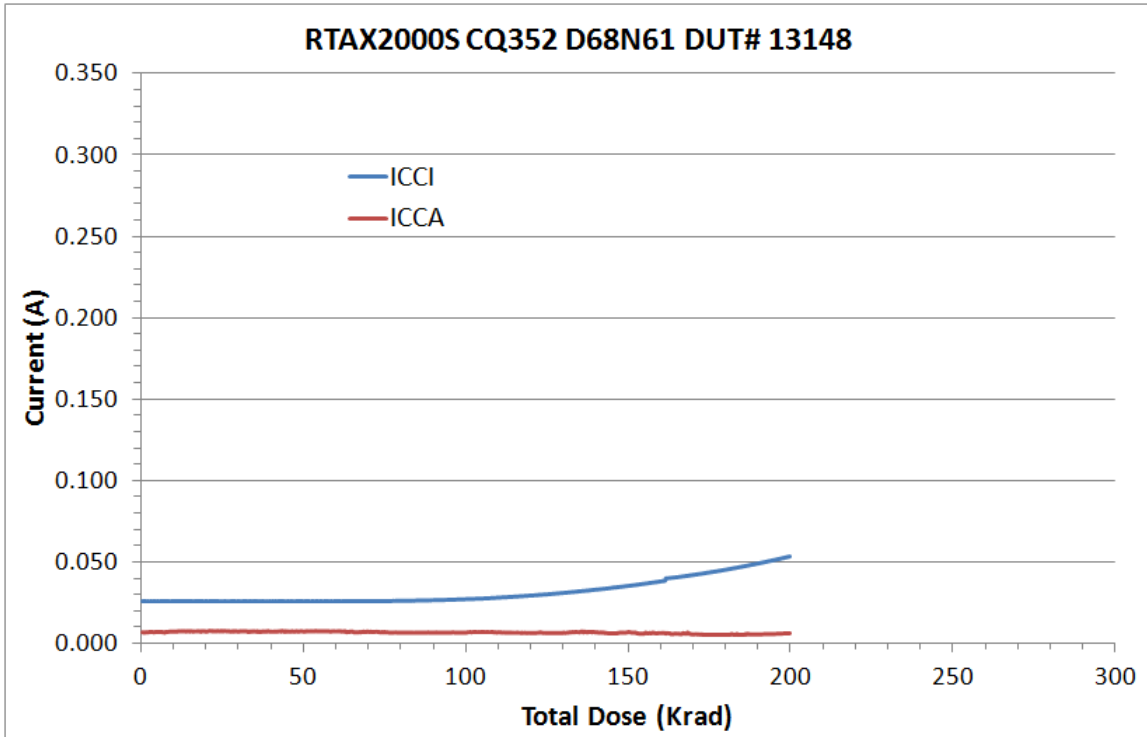

Figure 6 DUT 13148 Influx ICCA and ICCI

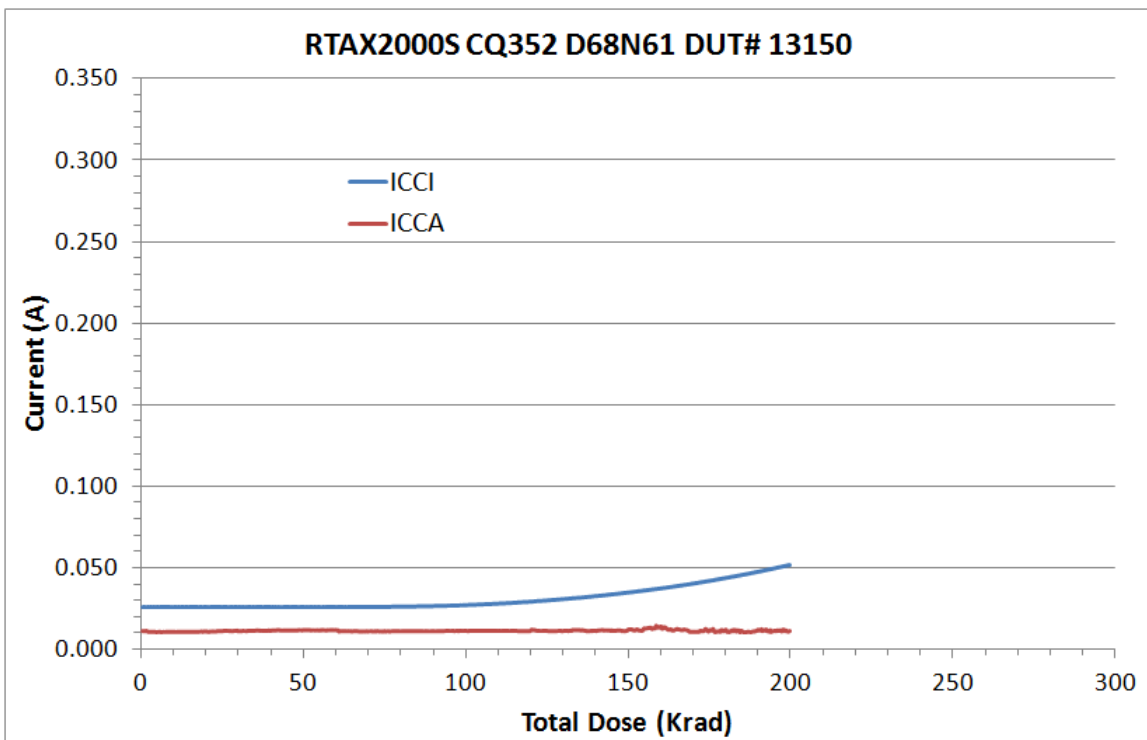

Figure 7 DUT 13150 Influx ICCA and ICCI

C. Single-Ended Input Logic Threshold (VIL/VIH)

Table 4a through Table 4c list the pre-irradiation and post-annealing single-ended input logic thresholds. All data are within the specification limits. The post-annealing shift in every case is very small.

Table 4a Pre-Irradiation and Post-Annealing Input Thresholds

DUT	13129 (300 krad)				13132 (300 krad)			
	Pre-Irrad	Post-Ann	Pre-Irrad	Post-Ann	Pre-Irrad	Post-Ann	Pre-Irrad	Post-Ann
	VIL (mV)		VIH (mV)		VIL (mV)		VIH (mV)	
DA	1420	1405	1395	1390	1405	1410	1380	1385
EN8	1395	1390	1395	1395	1385	1395	1380	1385
IO_I_6	1415	1400	1390	1395	1400	1405	1385	1385
IO_I_5	1400	1400	1400	1405	1390	1395	1390	1395
IO_I_4	1395	1390	1400	1400	1385	1385	1385	1395
IO_I_3	1350	1350	1415	1420	1335	1345	1415	1395
IO_I_2	1390	1390	1415	1415	1370	1375	1400	1405
IO_I_1	1385	1385	1400	1405	1375	1385	1395	1400

Table 4b Pre-Irradiation and Post-Annealing Input Thresholds

DUT	13134 (300 krad)				13137 (200 krad)			
	Pre-Irrad	Post-Ann	Pre-Irrad	Post-Ann	Pre-Irrad	Post-Ann	Pre-Irrad	Post-Ann
	VIL (mV)		VIH (mV)		VIL (mV)		VIH (mV)	
DA	1415	1410	1385	1390	1415	1410	1385	1385
EN8	1395	1395	1385	1395	1395	1395	1390	1390
IO_I_6	1405	1405	1385	1390	1405	1405	1385	1395
IO_I_5	1395	1400	1395	1405	1400	1405	1385	1400
IO_I_4	1385	1390	1390	1400	1385	1385	1390	1385
IO_I_3	1340	1350	1415	1430	1345	1350	1415	1425
IO_I_2	1375	1385	1405	1410	1380	1380	1400	1405
IO_I_1	1375	1390	1395	1405	1380	1385	1400	1400

Table 4c Pre-Irradiation and Post-Annealing Input Thresholds

DUT	13148 (200 krad)				13150 (200 krad)			
	Pre-Irrad	Post-Ann	Pre-Irrad	Post-Ann	Pre-Irrad	Post-Ann	Pre-Irrad	Post-Ann
	VIL (mV)		VIH (mV)		VIL (mV)		VIH (mV)	
DA	1405	1415	1380	1390	1415	1415	1385	1385
EN8	1385	1400	1385	1395	1395	1395	1390	1390
IO_I_6	1400	1410	1390	1385	1405	1410	1385	1395
IO_I_5	1390	1410	1395	1405	1395	1400	1380	1400
IO_I_4	1385	1385	1390	1390	1390	1390	1385	1390
IO_I_3	1345	1350	1415	1425	1345	1350	1420	1425
IO_I_2	1385	1385	1400	1410	1380	1385	1410	1410
IO_I_1	1380	1390	1395	1405	1375	1390	1395	1405

D. Differential Input (LVPECL) Threshold Voltage (VIL/VIH)

Table 5a through Table 5c list the LVPECL differential input threshold voltage changes due to irradiations. All pins show negligible changes, and all the data are within the specification.

Table 5a Pre-Irradiation and Post-Annealing Differential Input Thresholds

DUT	13129 (300 krad)				13132 (300 krad)			
	Pre-Irrad	Post-Ann	Pre-Irrad	Post-Ann	Pre-Irrad	Post-Ann	Pre-Irrad	Post-Ann
	VIL (mV)		VIH (mV)		VIL (mV)		VIH (mV)	
DIO_IP_7	1790	1795	1790	1795	1785	1795	1785	1790
DIO_IP_6	1780	1790	1785	1795	1785	1780	1790	1790
DIO_IP_5	1795	1790	1790	1790	1785	1785	1785	1785
DIO_IP_4	1780	1775	1790	1780	1790	1780	1790	1790
DIO_IP_3	1800	1800	1795	1795	1795	1800	1785	1795
DIO_IP_2	1795	1790	1790	1785	1790	1785	1790	1785
DIO_IP_1	1795	1795	1790	1790	1795	1795	1790	1790

Table 5b Pre-Irradiation and Post-Annealing Differential Input Thresholds

DUT	13134 (300 krad)				13137 (200 krad)			
	Pre-Irrad	Post-Ann	Pre-Irrad	Post-Ann	Pre-Irrad	Post-Ann	Pre-Irrad	Post-Ann
	VIL (mV)		VIH (mV)		VIL (mV)		VIH (mV)	
DIO_IP_7	1790	1795	1790	1790	1785	1790	1785	1790
DIO_IP_6	1780	1780	1780	1790	1780	1785	1785	1795
DIO_IP_5	1790	1790	1785	1785	1790	1790	1785	1790
DIO_IP_4	1785	1785	1790	1790	1780	1780	1785	1790
DIO_IP_3	1790	1795	1785	1790	1790	1790	1785	1785
DIO_IP_2	1785	1790	1785	1790	1790	1790	1790	1790
DIO_IP_1	1795	1795	1790	1795	1790	1800	1785	1795

Table 5c Pre-Irradiation and Post-Annealing Differential Input Thresholds

DUT	13148 (200 krad)				13150 (200 krad)			
	Pre-Irrad	Post-Ann	Pre-Irrad	Post-Ann	Pre-Irrad	Post-Ann	Pre-Irrad	Post-Ann
	VIL (mV)		VIH (mV)		VIL (mV)		VIH (mV)	
DIO_IP_7	1800	1795	1795	1790	1790	1790	1785	1790
DIO_IP_6	1780	1785	1785	1790	1785	1780	1790	1790
DIO_IP_5	1790	1795	1785	1790	1795	1795	1795	1795
DIO_IP_4	1775	1785	1785	1790	1785	1785	1785	1790
DIO_IP_3	1790	1795	1785	1790	1785	1790	1780	1785
DIO_IP_2	1795	1785	1795	1785	1785	1790	1785	1790
DIO_IP_1	1795	1795	1790	1790	1790	1795	1785	1790

E. Output-Drive Voltage (VOL/VOH)

The pre-irradiation and post-annealing VOL/VOH are listed in Tables 6 and 7. The post-annealing data are within the specification limits.

Table 6 Pre-Irradiation and Post-Annealing VOL (mV) at Various Sinking Current

Sourcing Current	Pin\DUT	13129 (300 krad)		13132 (300 krad)		13134 (300 krad)		13137 (200 krad)		13148 (200 krad)		13150 (200 krad)	
		Pre-rad	Post-an	Pre-rad	Post-an	Pre-rad	Post-an	Pre-rad	Post-an	Pre-rad	Post-an	Pre-rad	Post-an
1 mA	QA0	8	8	8	8	8	8	8	8	8	8	8	8
	YQ0	9	9	9	9	9	9	9	9	9	9	9	9
12 mA	QA0	96	88	95	88	94	89	95	89	96	88	95	89
	YQ0	105	99	105	101	104	99	105	100	105	99	104	98
20 mA	QA0	160	148	158	147	157	149	159	148	160	148	160	149
	YQ0	175	166	176	167	173	165	175	166	175	166	175	164
50 mA	QA0	407	375	403	374	400	380	405	377	406	375	408	378
	YQ0	444	420	446	423	439	418	446	422	445	421	443	416
100 mA	QA0	865	795	858	792	851	805	861	800	863	796	867	802
	YQ0	939	885	943	892	929	882	942	890	943	888	937	878

Table 7 Pre-Irradiation and Post-Annealing VOH (mV) at Various Sourcing Current

Sourcing Current	Pin\DUT	13129 (300 krad)		13132 (300 krad)		13134 (300 krad)		13137 (200 krad)		13148 (200 krad)		13150 (200 krad)	
		Pre-rad	Post-an	Pre-rad	Post-an	Pre-rad	Post-an	Pre-rad	Post-an	Pre-rad	Post-an	Pre-rad	Post-an
1 mA	QA0	3287	3287	3287	3287	3287	3287	3287	3289	3287	3289	3287	3289
	YQ0	3286	3285	3285	3285	3285	3285	3285	3286	3285	3287	3286	3287
8 mA	QA0	3219	3220	3218	3220	3219	3220	3218	3222	3218	3222	3218	3221
	YQ0	3213	3213	3210	3211	3212	3213	3211	3214	3210	3214	3212	3215
20 mA	QA0	3100	3104	3097	3103	3100	3102	3098	3106	3096	3106	3097	3105
	YQ0	3085	3088	3080	3085	3084	3088	3083	3089	3081	3088	3084	3090
50 mA	QA0	2786	2797	2779	2796	2786	2792	2781	2800	2777	2799	2777	2797
	YQ0	2755	2760	2740	2752	2752	2760	2747	2759	2741	2760	2749	2764
100 mA	QA0	2179	2197	2160	2197	2175	2186	2164	2202	2154	2202	2154	2197
	YQ0	2121	2127	2081	2111	2107	2126	2097	2125	2083	2127	2105	2135

F. Propagation Delay

The propagation delay was measured in-situ, post-irradiation, and post-annealing. The irradiation was temporarily stopped at each total-dose increment of 100 krad for the measurement. Each measurement has a 2-minute wait after a DUT is removed from the chamber. The results are plotted in Figure 8, and listed in Table 8. As shown in Figure 8, the propagation delay initially decreases with the total dose, but the change is small throughout the irradiation. Referring to influx static current plots (Figure 2 through Figure 7), a device probably heats up as the dose increases. The rising temperature could be the root cause of the increasing trend at high doses. The post-annealing data, on the other hand, show decreased delay in every case.

The radiation delta in every case is well within the 10% degradation criterion. User can take the worst case for the design-margin consideration.

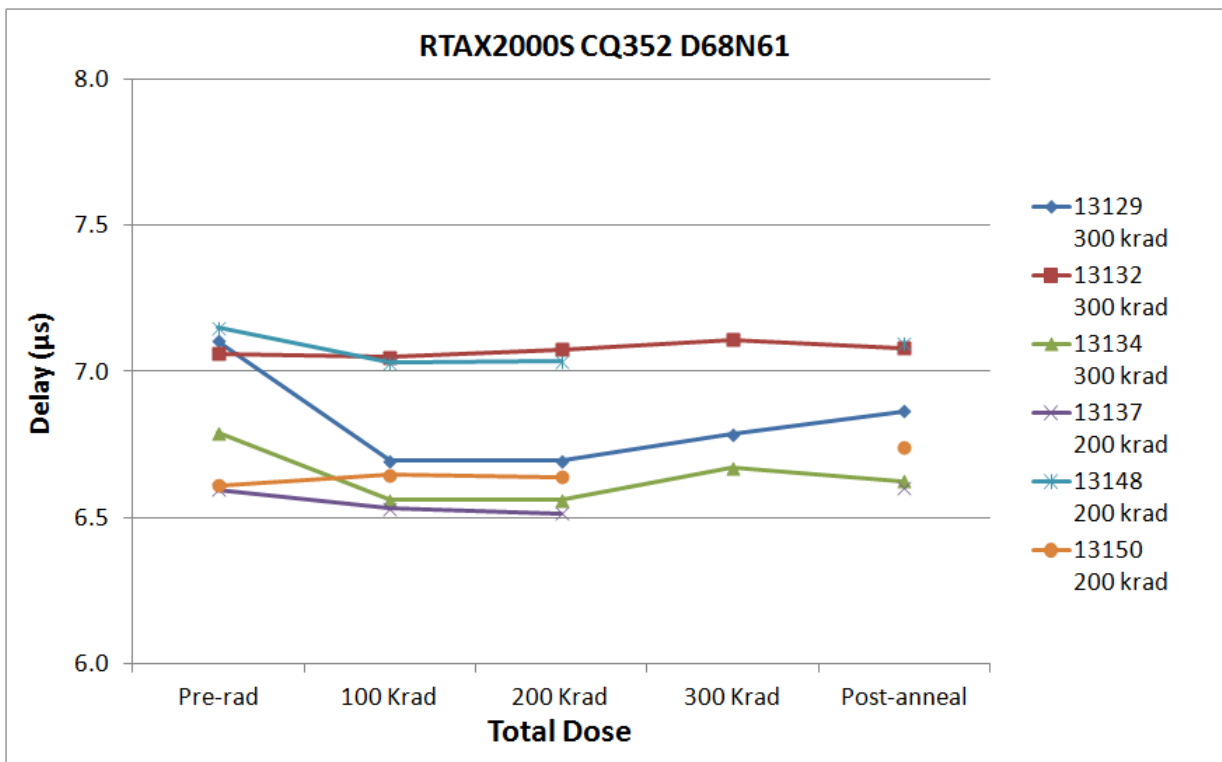

Figure 8 In-Situ Propagation Delay versus Total Dose.
The measurement is performed outside the irradiation chamber.

Table 8 Radiation-Induced Propagation-Delay Degradations

RTAX2000S CQ352 D68N61							
Delay (μs)							
	DUT	Total Dose	Pre-rad	100 krad	200 krad	300 krad	Post-ann
	13129	300 krad	7.11	6.70	6.70	6.79	6.87
	13132	300 krad	7.06	7.05	7.08	7.11	7.08
	13134	300 krad	6.79	6.56	6.56	6.67	6.63
	13137	200 krad	6.60	6.53	6.52	-	6.60
	13148	200 krad	7.15	7.03	7.04	-	7.10
	13150	200 krad	6.61	6.65	6.64	-	6.74
Radiation Δ (%)							
	DUT	Total Dose	Pre-rad	100 krad	200 krad	300 krad	Post-ann
	13129	300 krad	-	-5.77%	-5.77%	-4.50%	-3.38%
	13132	300 krad	-	-0.14%	0.21%	0.71%	0.28%
	13134	300 krad	-	-3.39%	-3.39%	-1.77%	-2.43%
	13137	200 krad	-	-0.99%	-1.21%	-	0.08%
	13148	200 krad	-	-1.68%	-1.61%	-	-0.77%
	13150	200 krad	-	0.53%	0.45%	-	1.97%

G. Transition Characteristics

Figure 9a to Figure 20b show the pre-irradiation and post-annealing transition edges. In each case, the radiation-induced transition-time degradation is insignificant.

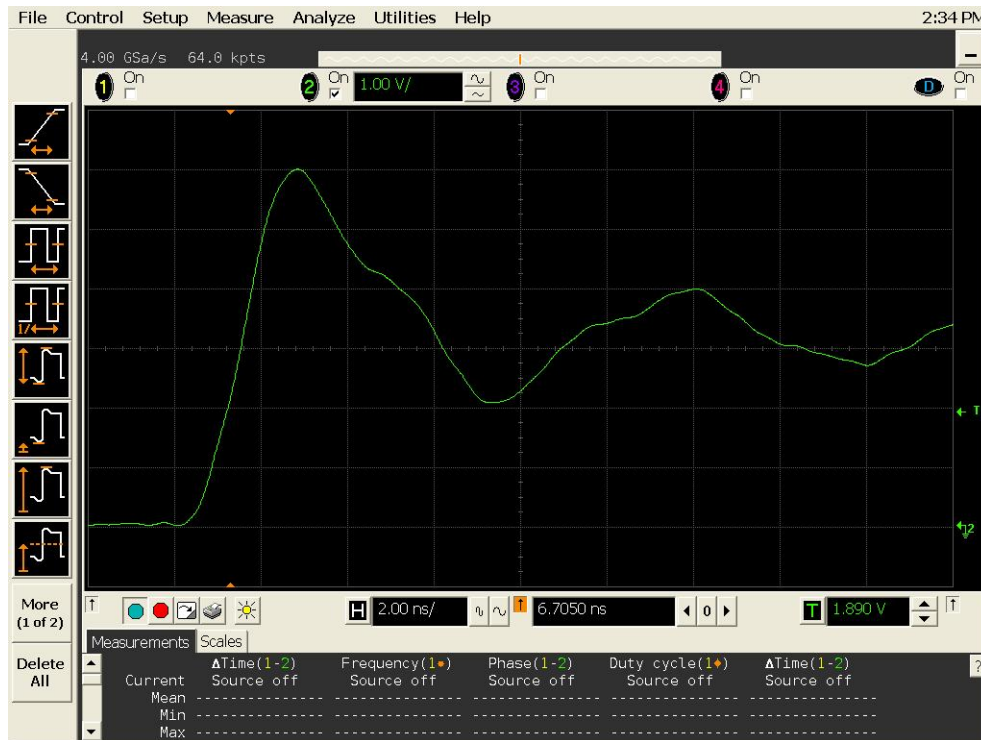

Figure 9a DUT 13129 Pre-Irradiation Rising Edge

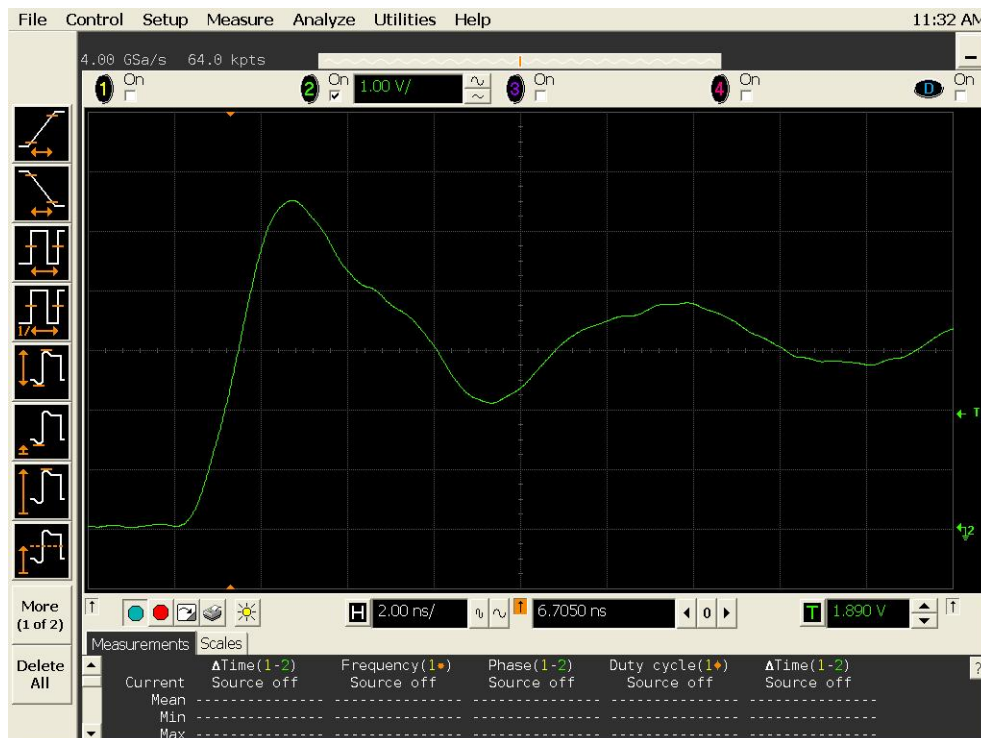

Figure 9b DUT 13129 Post-Annealing Rising Edge

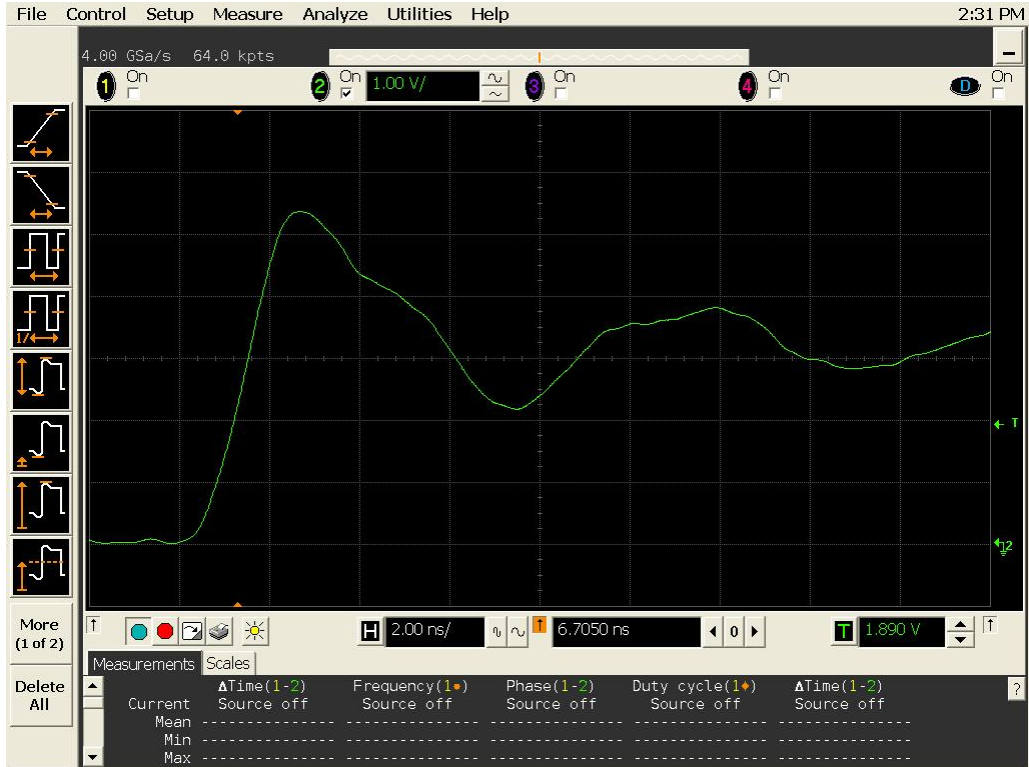

Figure 10a DUT 13132 Pre-Irradiation Rising Edge

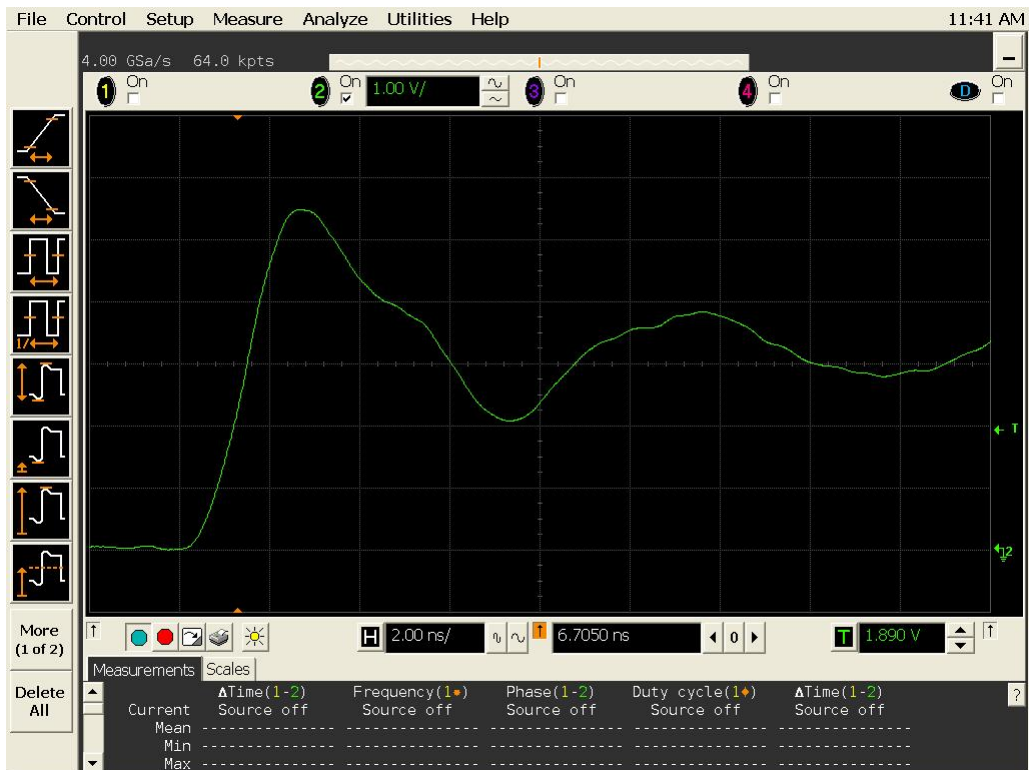

Figure 10b DUT 13132 Post-Annealing Rising Edge

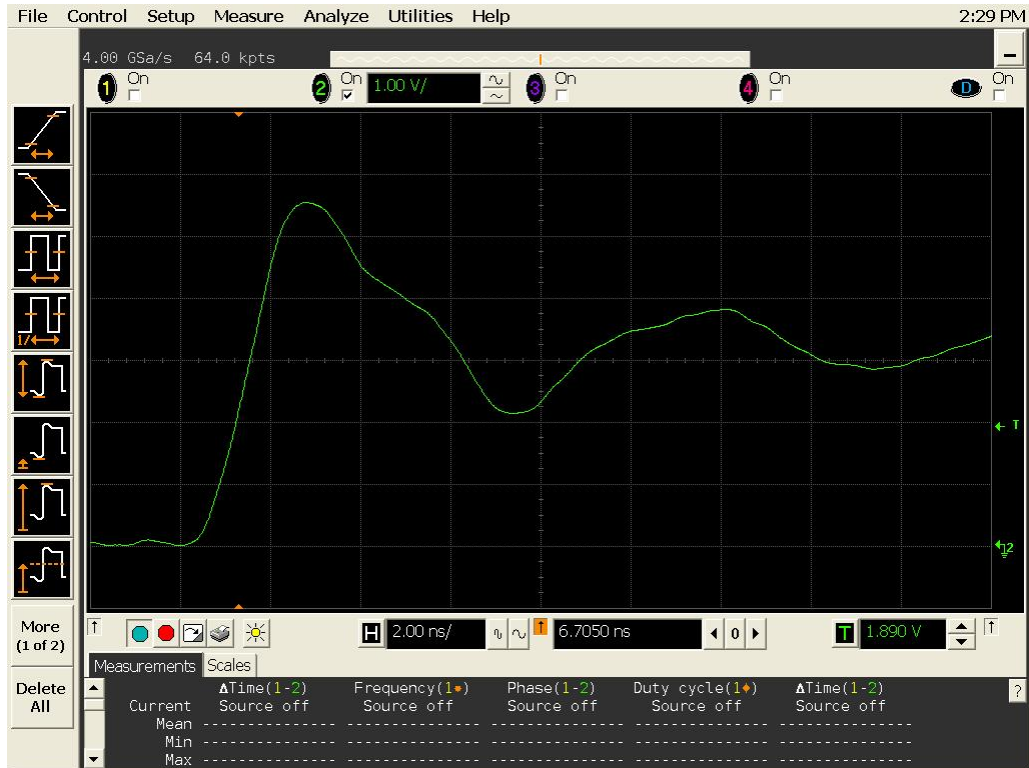

Figure 11a DUT 13134 Pre-Radiation Rising Edge

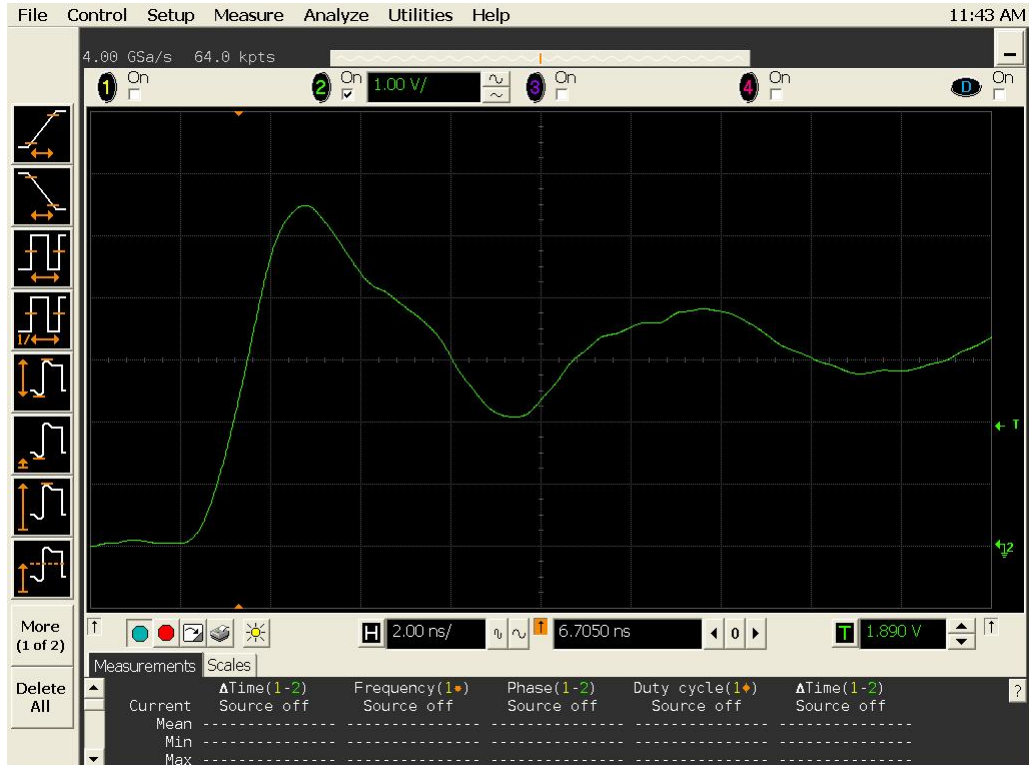

Figure 11b DUT 13134 Post-Annealing Rising edge

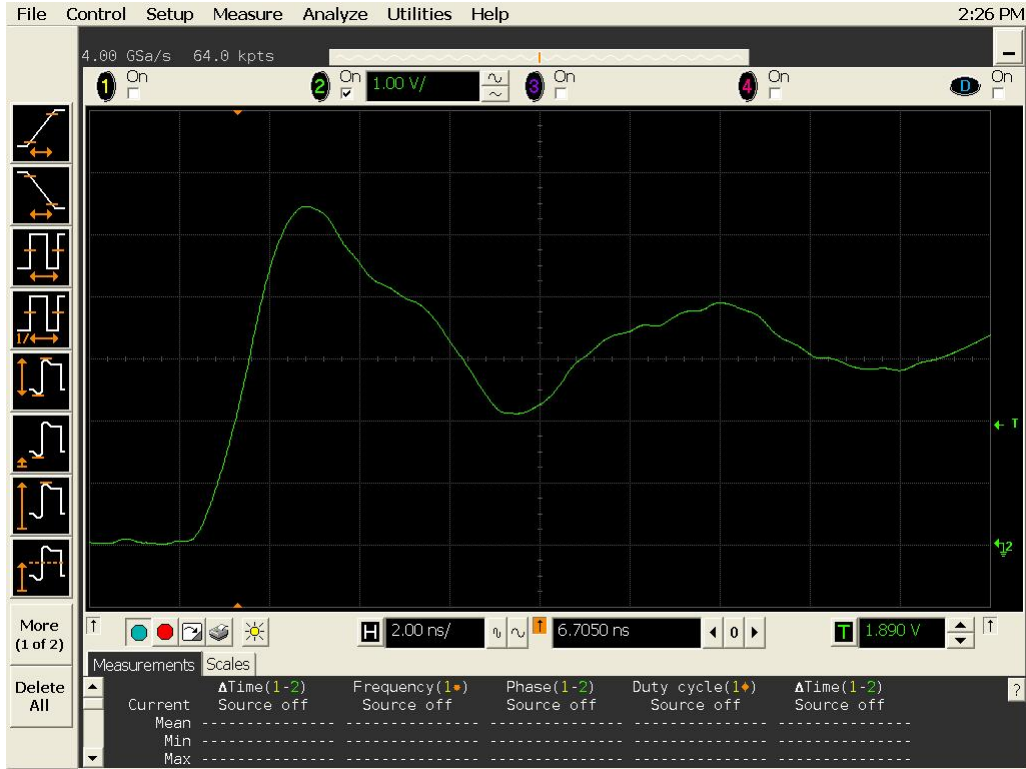

Figure 12a DUT 13137 Pre-Irradiation Rising Edge

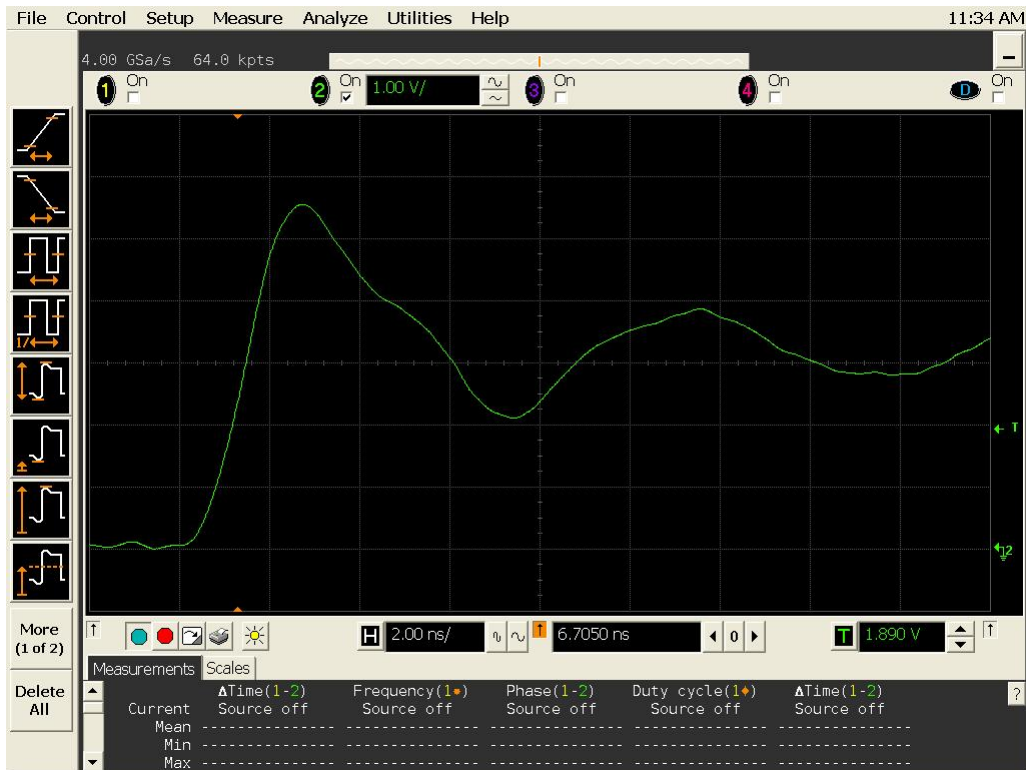

Figure 12b DUT 13137 Post-Annealing Rising Edge

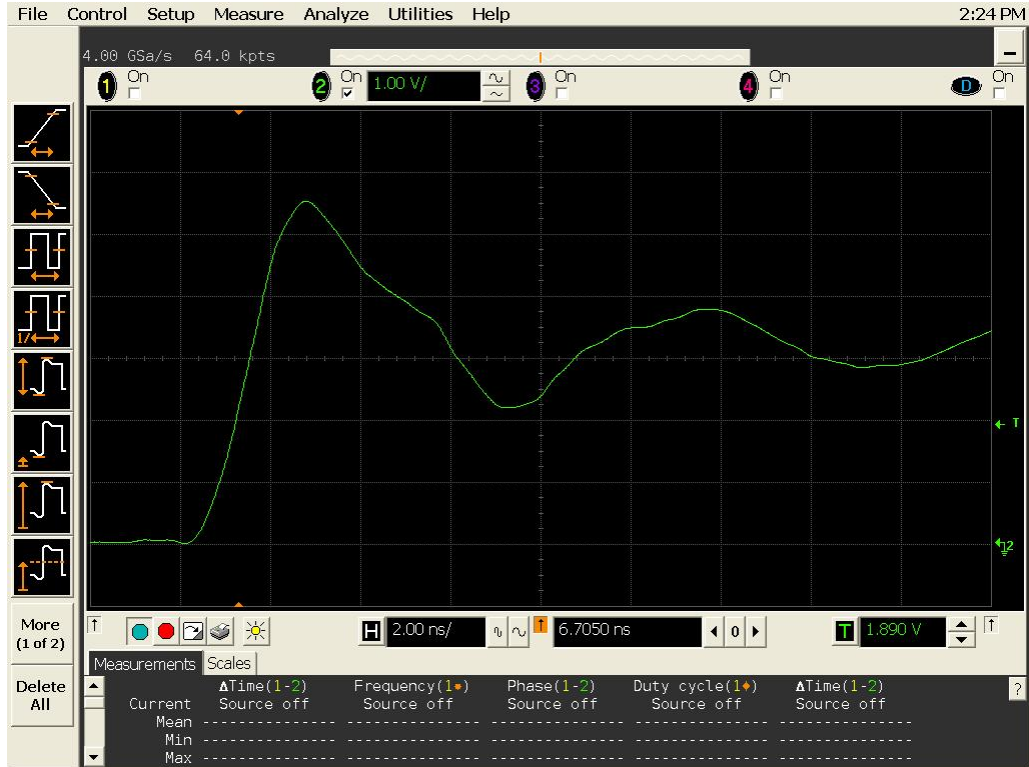

Figure 13a DUT 13148 Pre-Irradiation Rising Edge

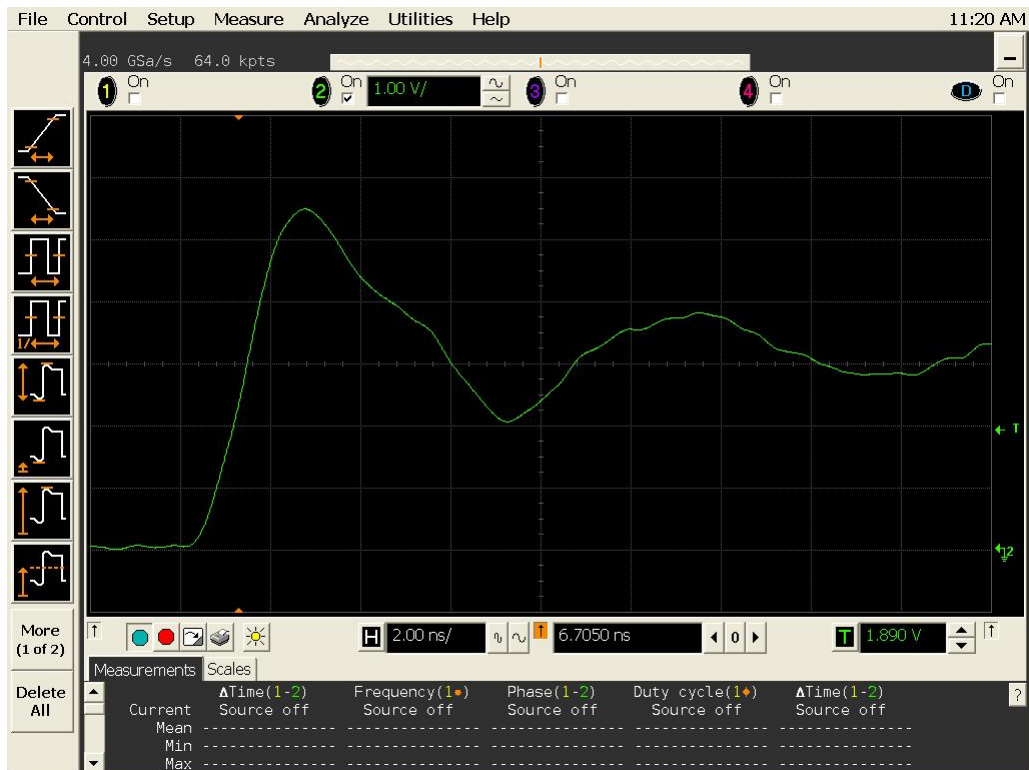

Figure 13b DUT 13148 Post-Annealing Rising Edge

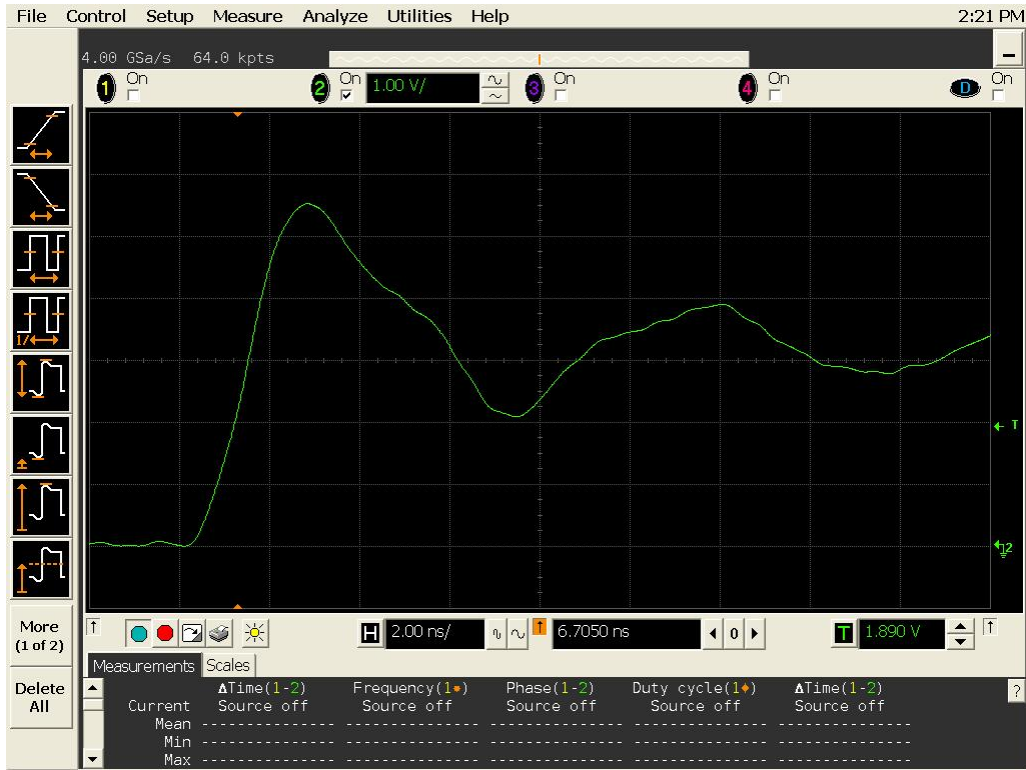

Figure 14a DUT 13150 Pre-Irradiation Rising Edge

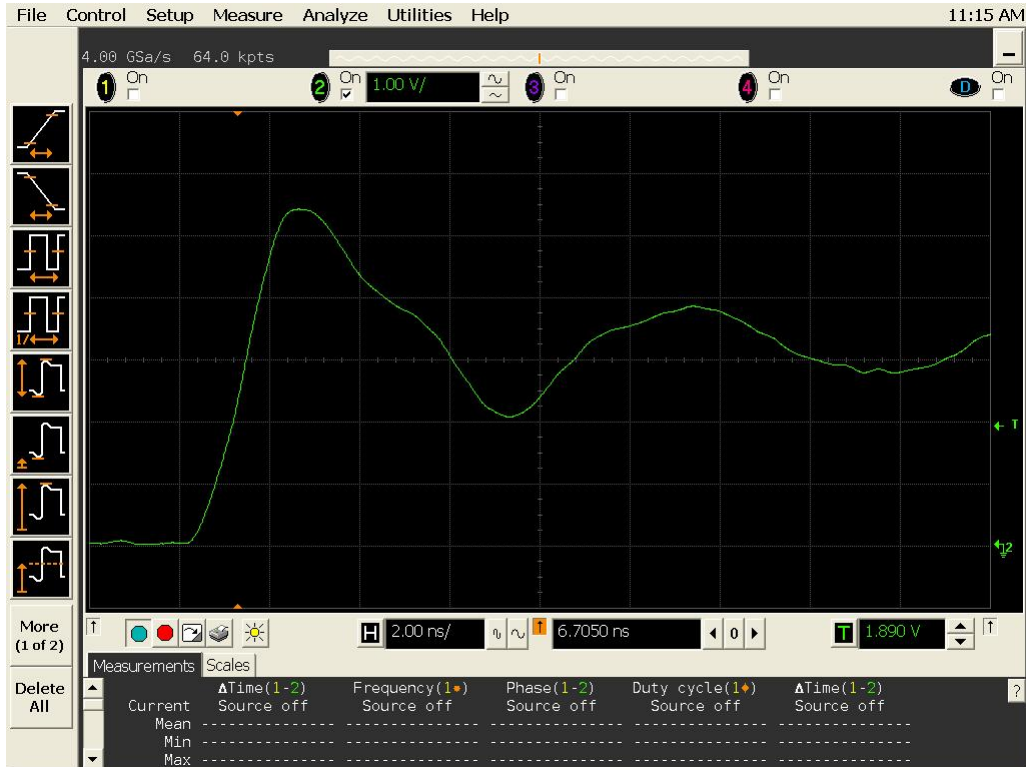

Figure 14b DUT 13150 Post-Annealing Rising Edge

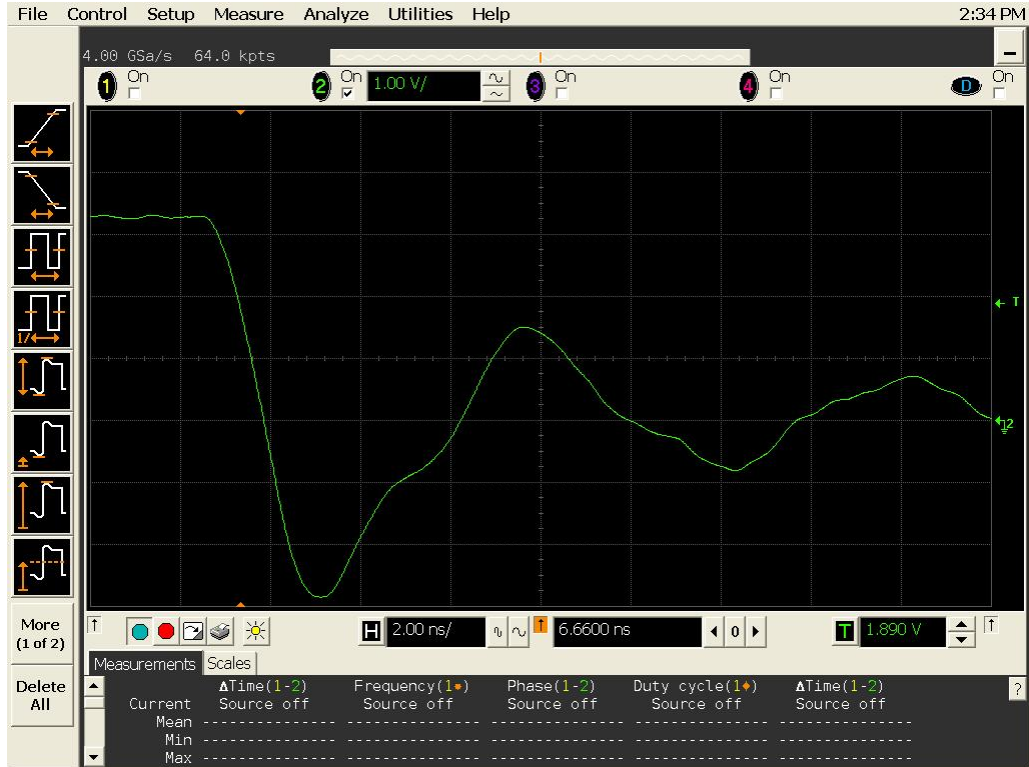

Figure 15a DUT 13129 Pre-Radiation Falling Edge

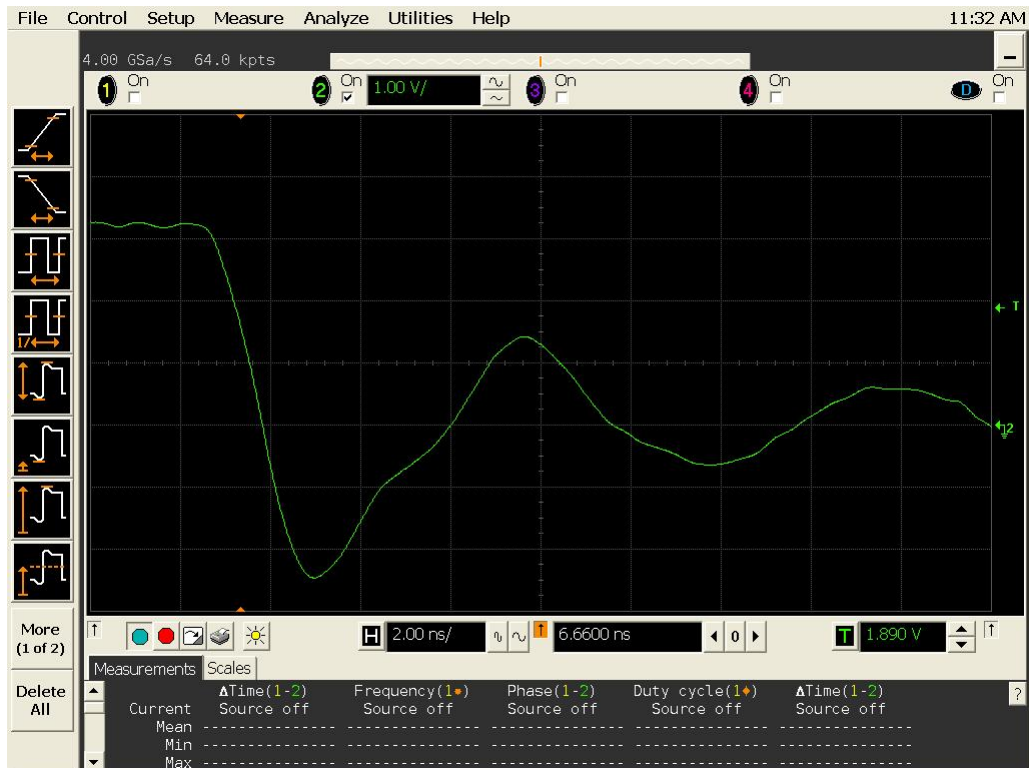

Figure 15b DUT 13129 Post-Annealing Falling Edge

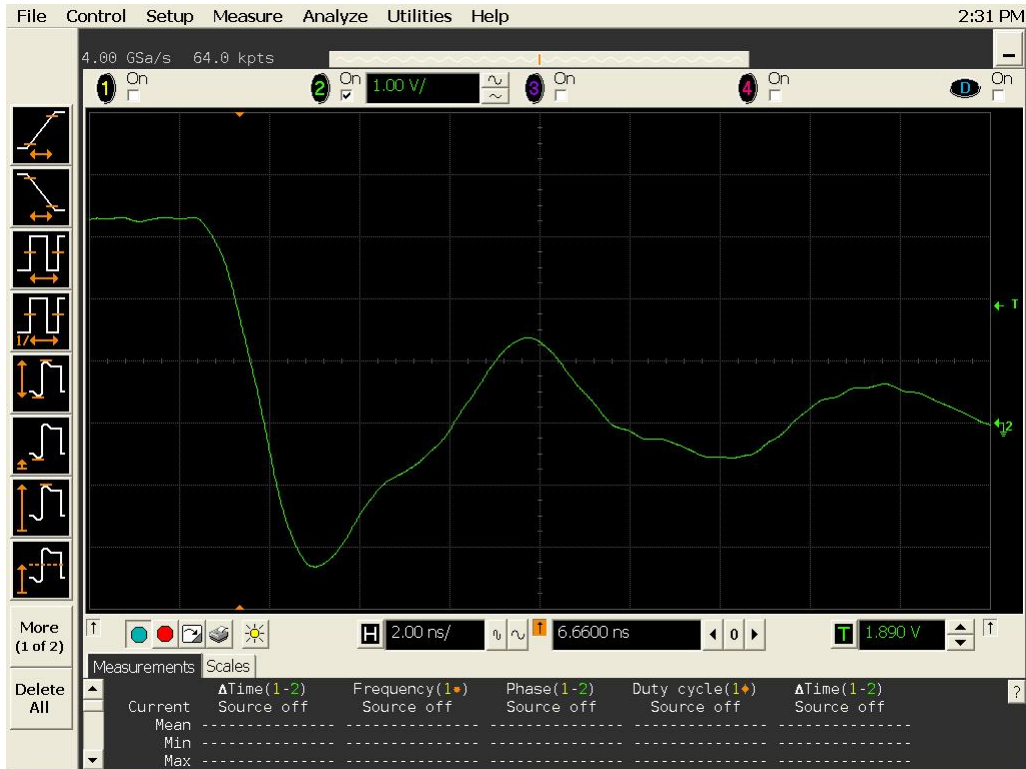

Figure 16a DUT 13132 Pre-Irradiation Falling Edge

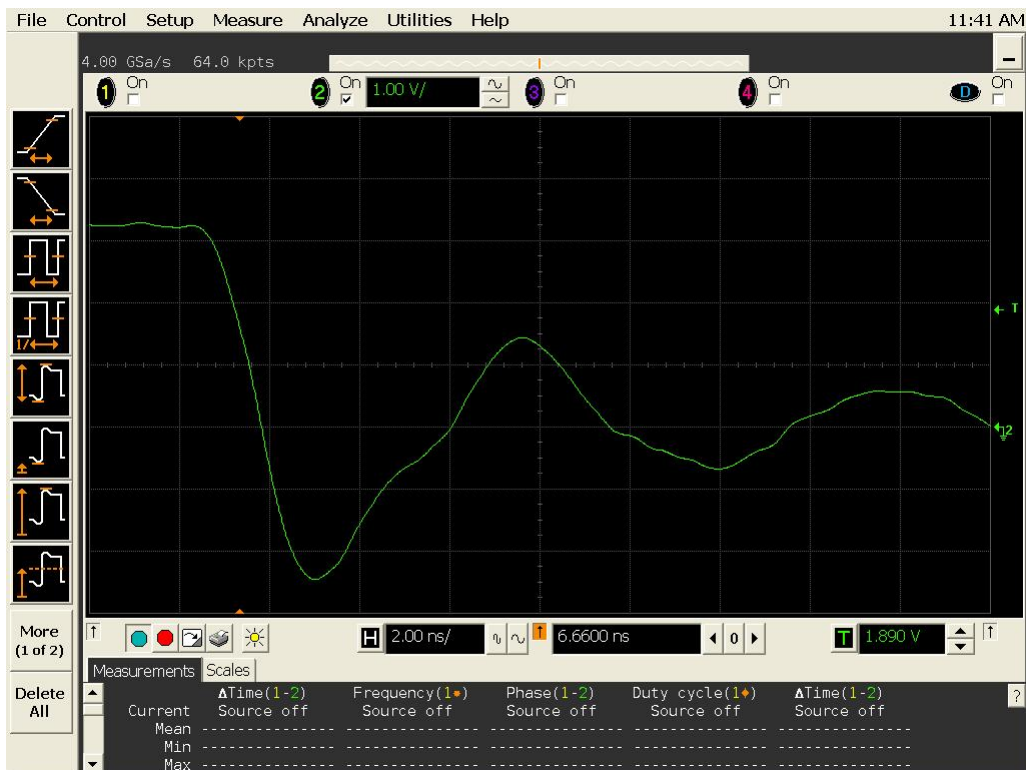

Figure 16b DUT 13132 Post-Annealing Falling Edge

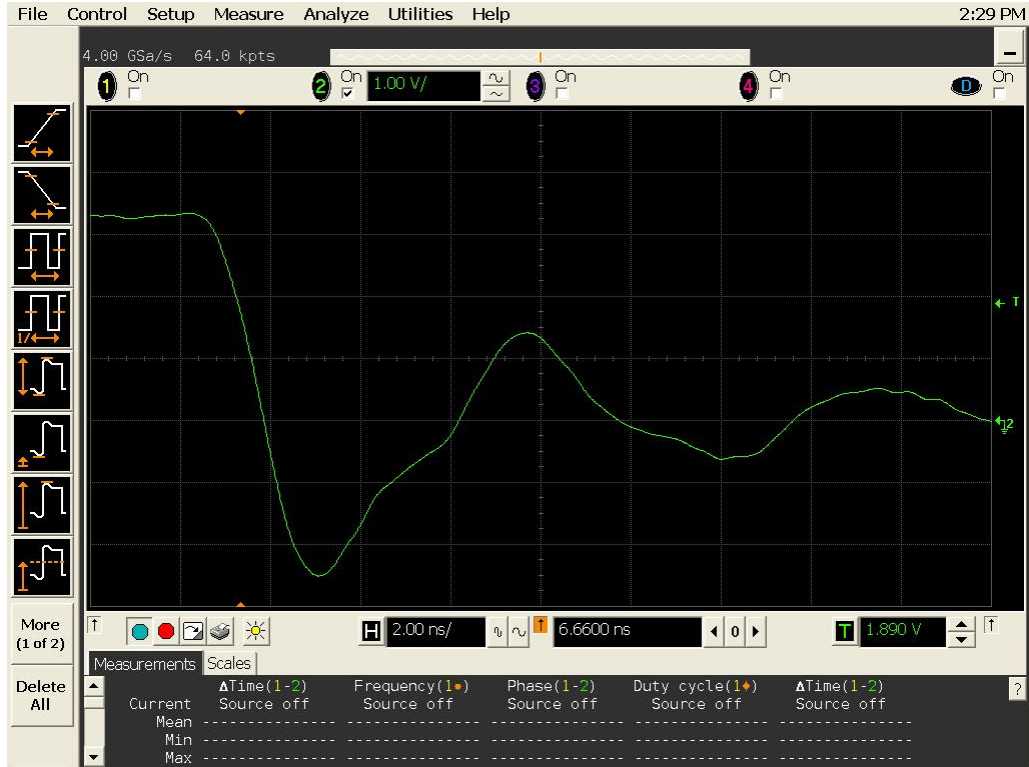

Figure 17a DUT 13134 Pre-Irradiation Falling Edge

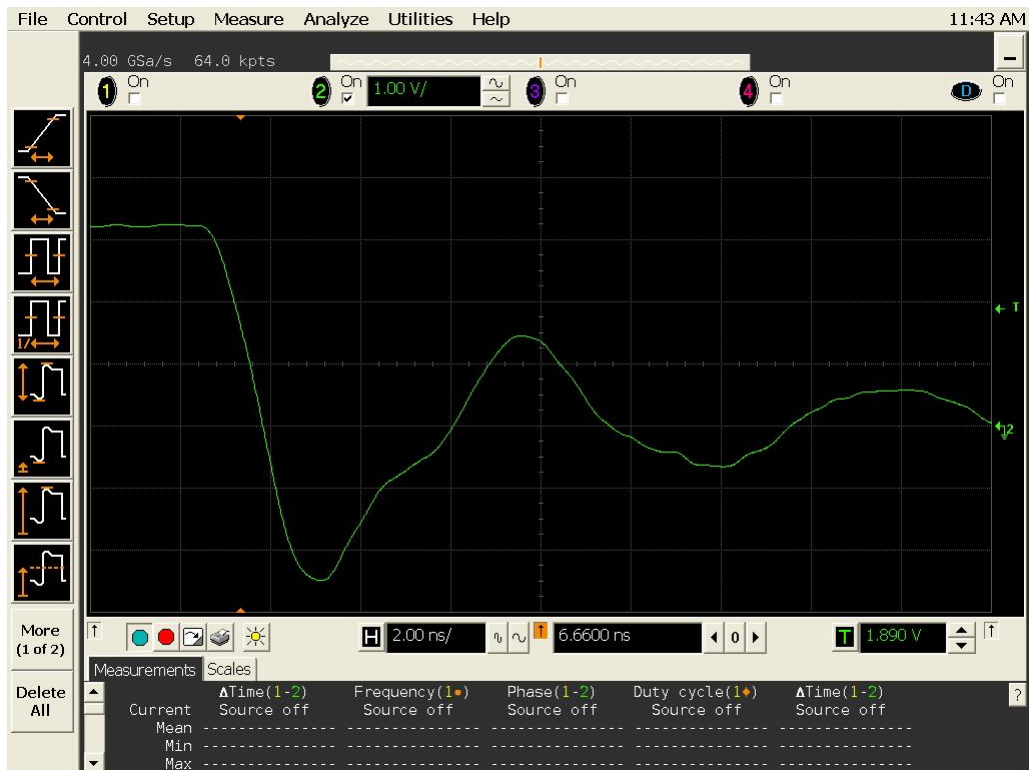

Figure 17b DUT 13134 Post-Annealing Falling Edge

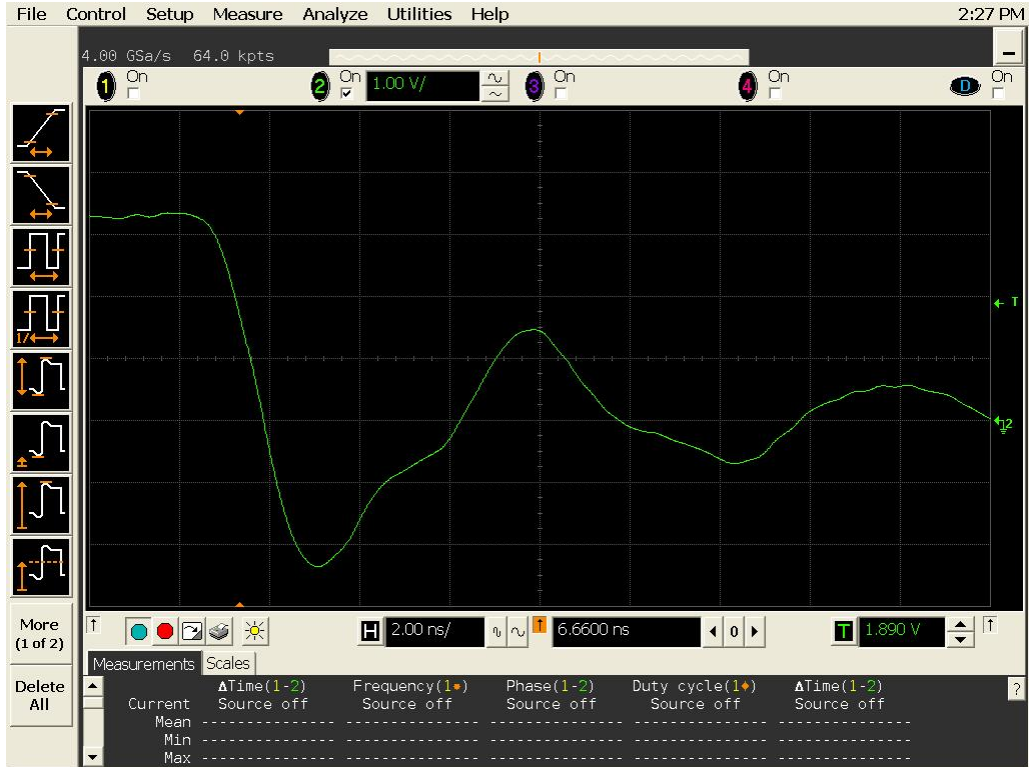

Figure 18a DUT 13137 Pre-Irradiation Falling Edge

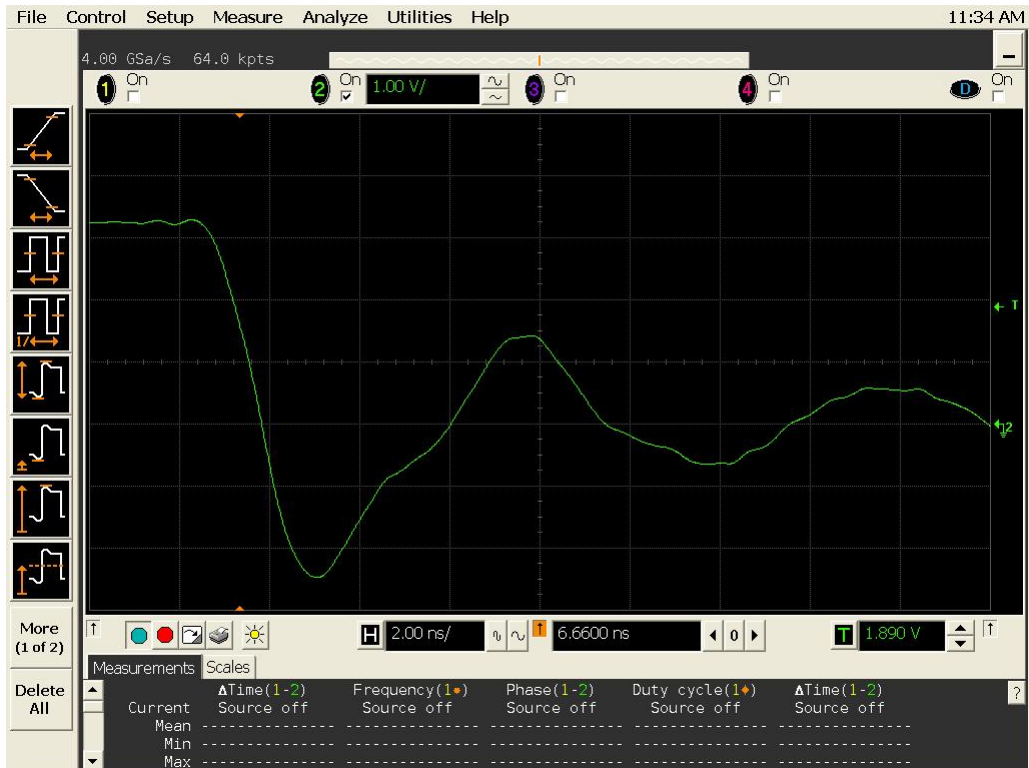

Figure 18b DUT 13137 Post-Annealing Falling Edge

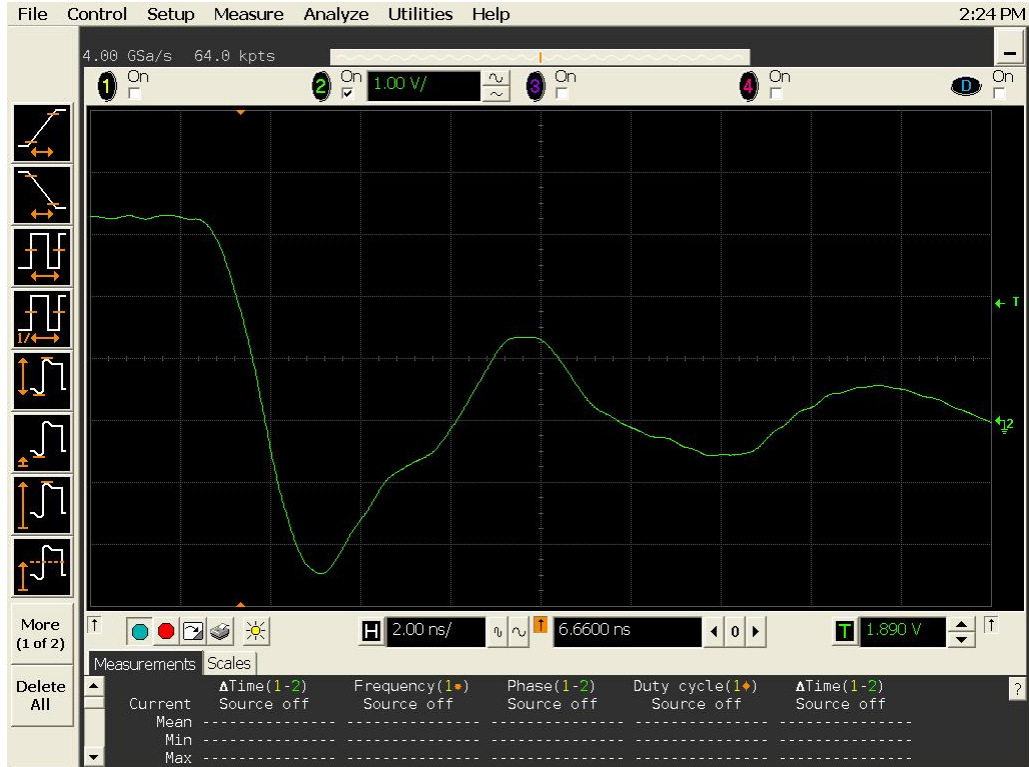

Figure 19a DUT 13148 Pre-Irradiation Falling Edge

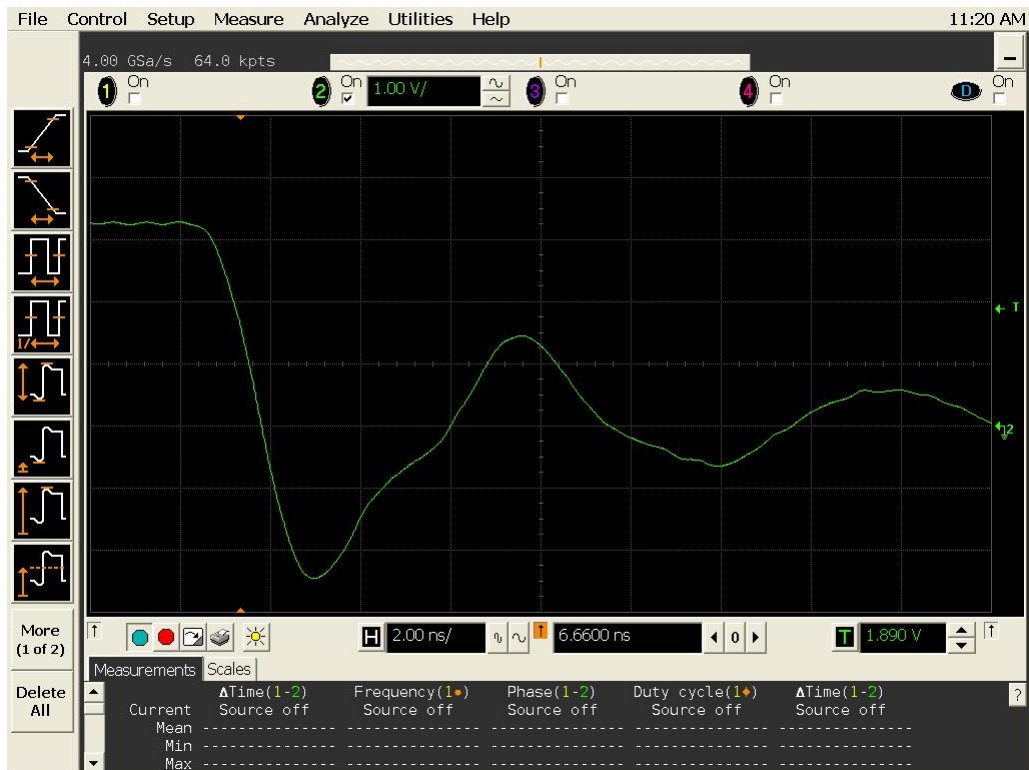

Figure 19b DUT 13148 Post-Annealing Falling Edge

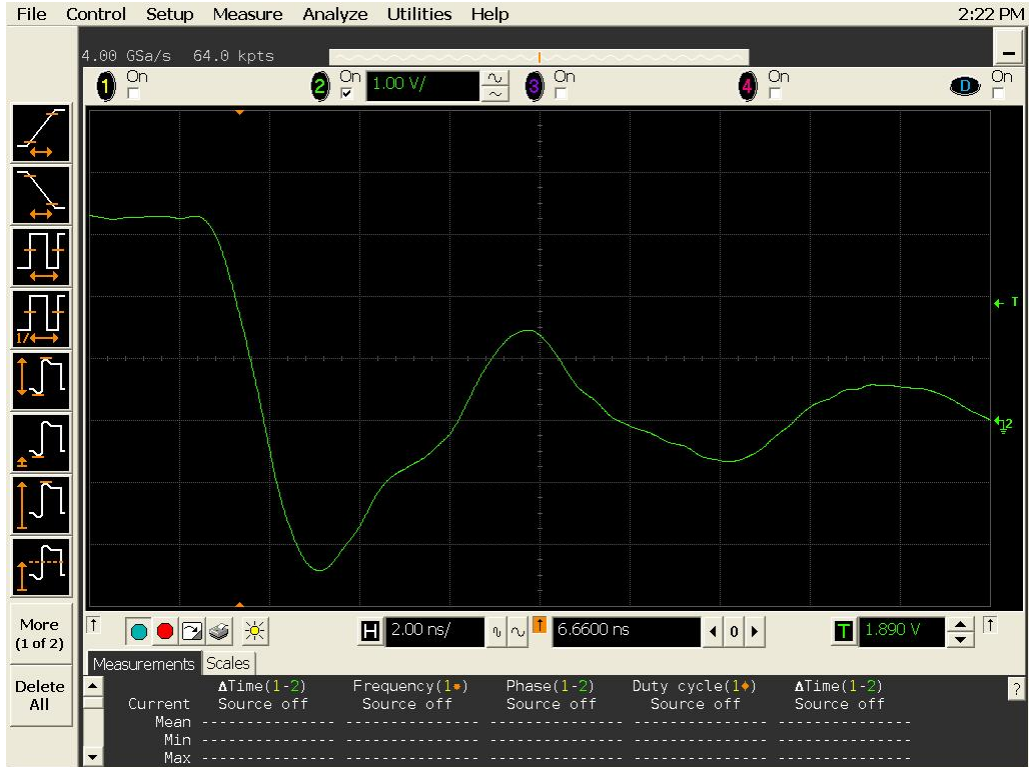

Figure 20a DUT 13150 Pre-Irradiation Falling Edge

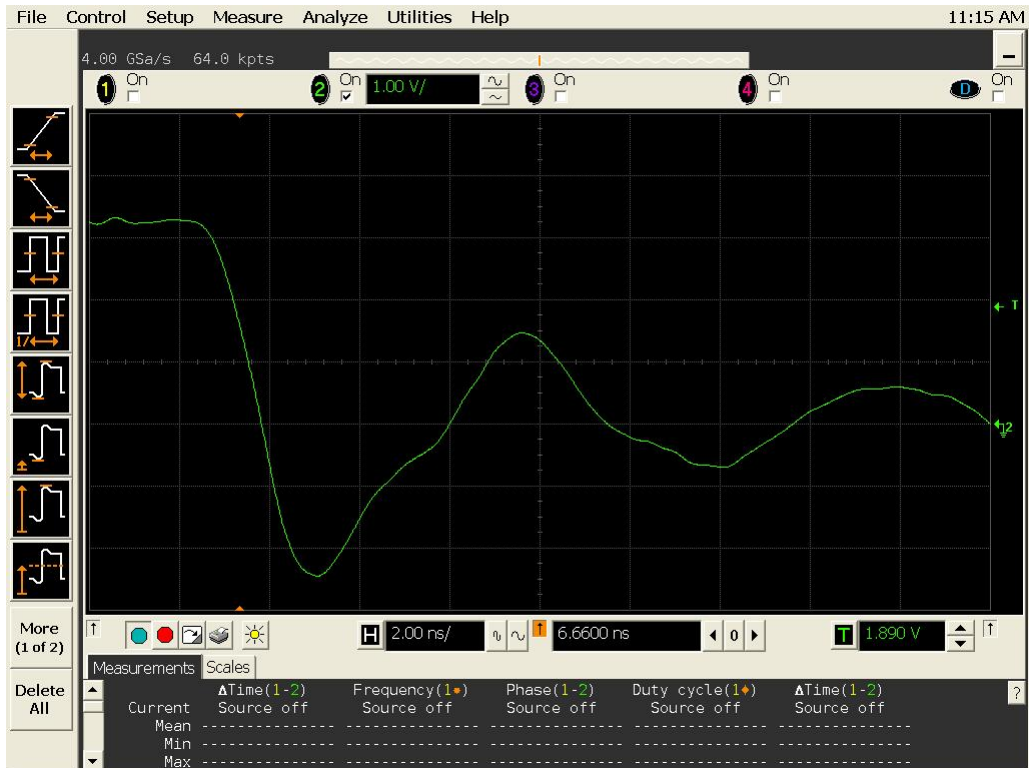

Figure 20b DUT 13150 Post-Annealing Falling Edge

Appendix A: DUT Bias



Figure A1 I/O Bias During Irradiation

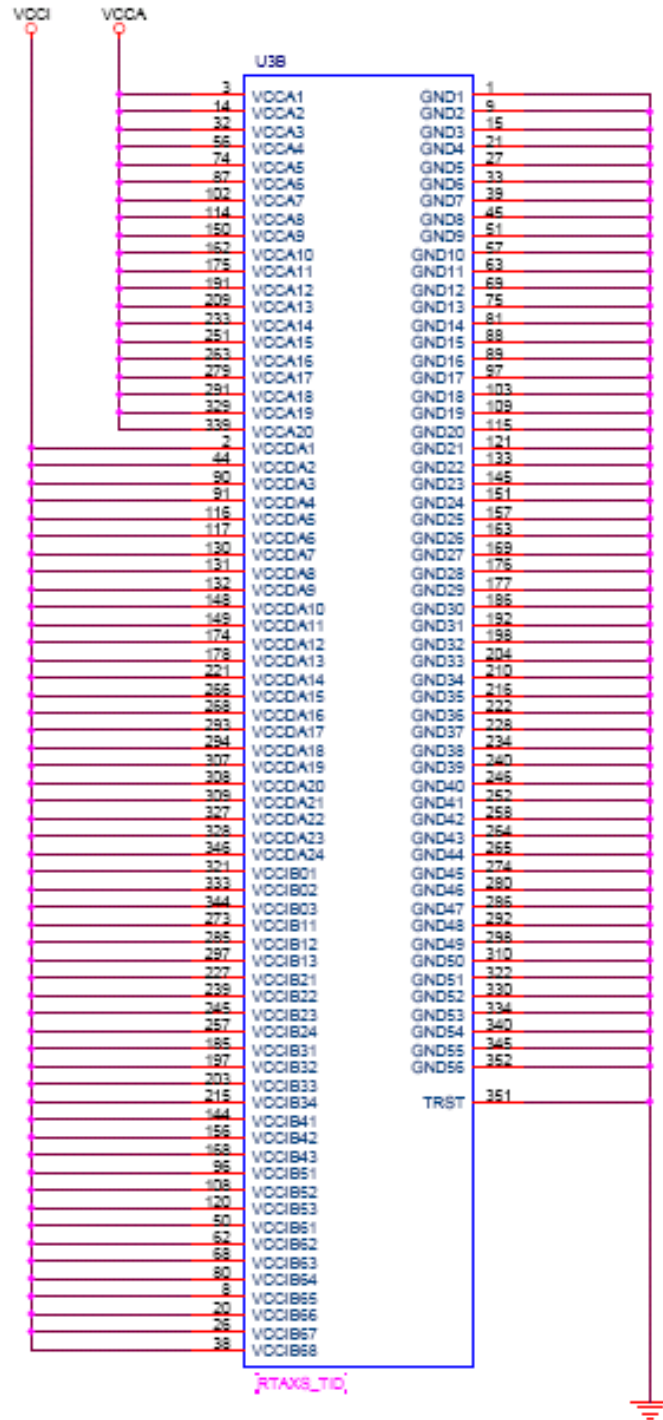
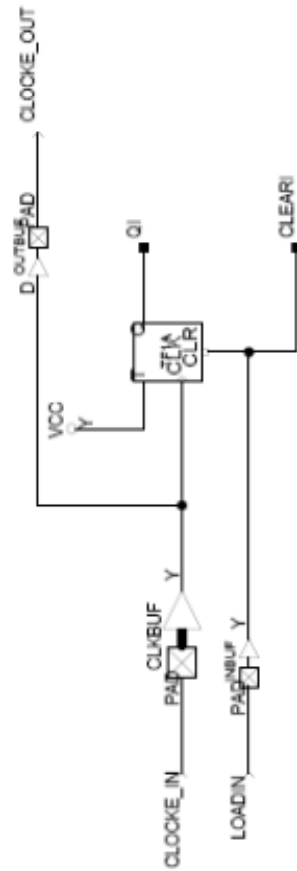
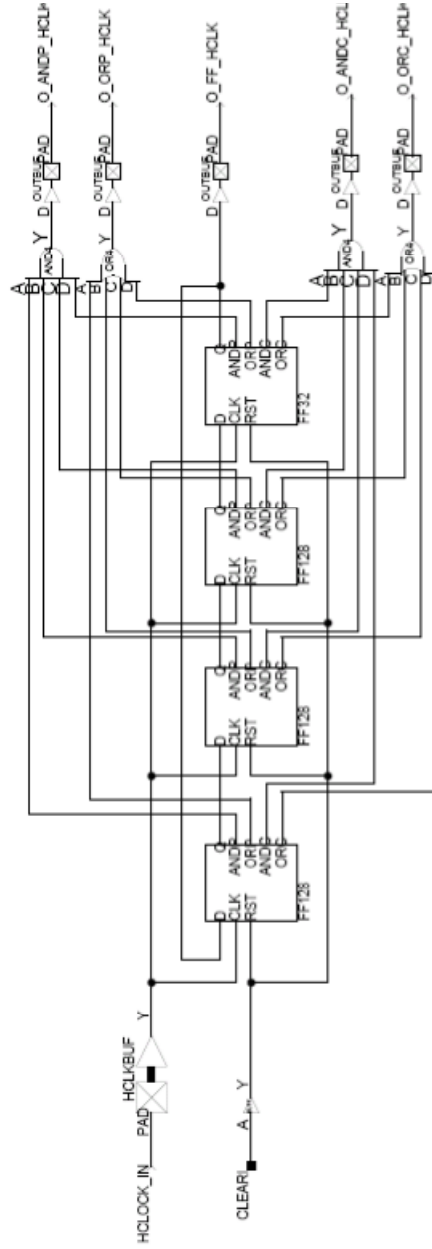

Figure A2 Power Supply, Ground and Special Pins Bias During Irradiation

Appendix B: DUT Design Schematics and Verilog Files







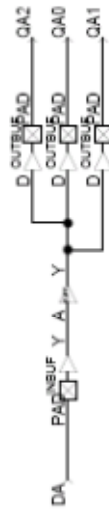
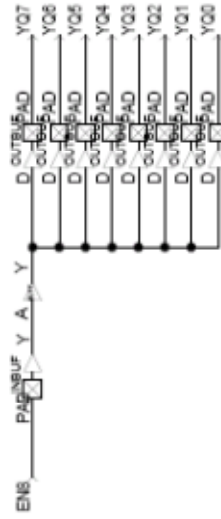

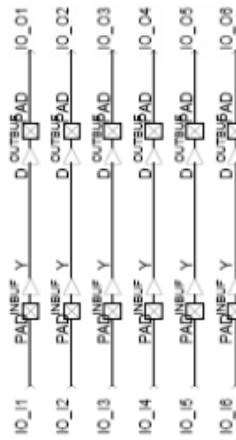
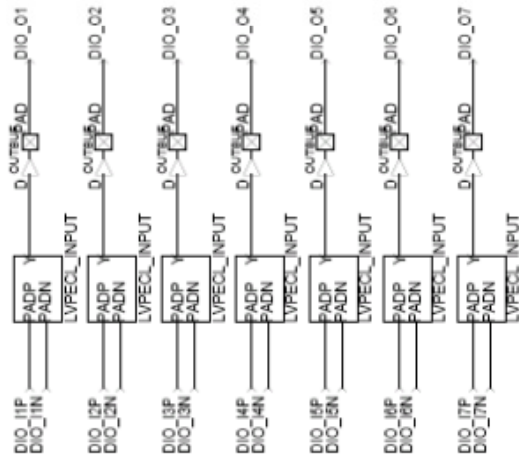

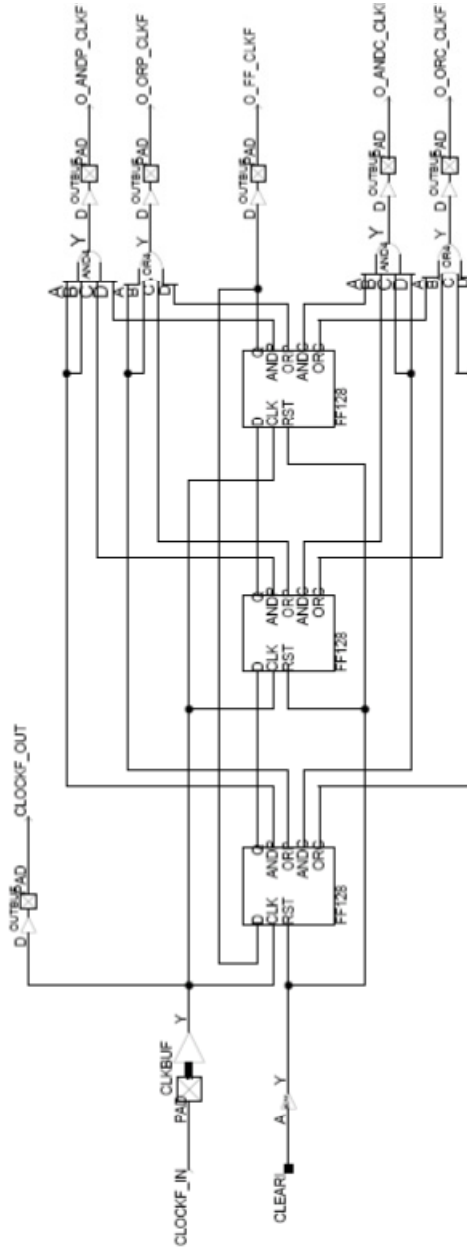

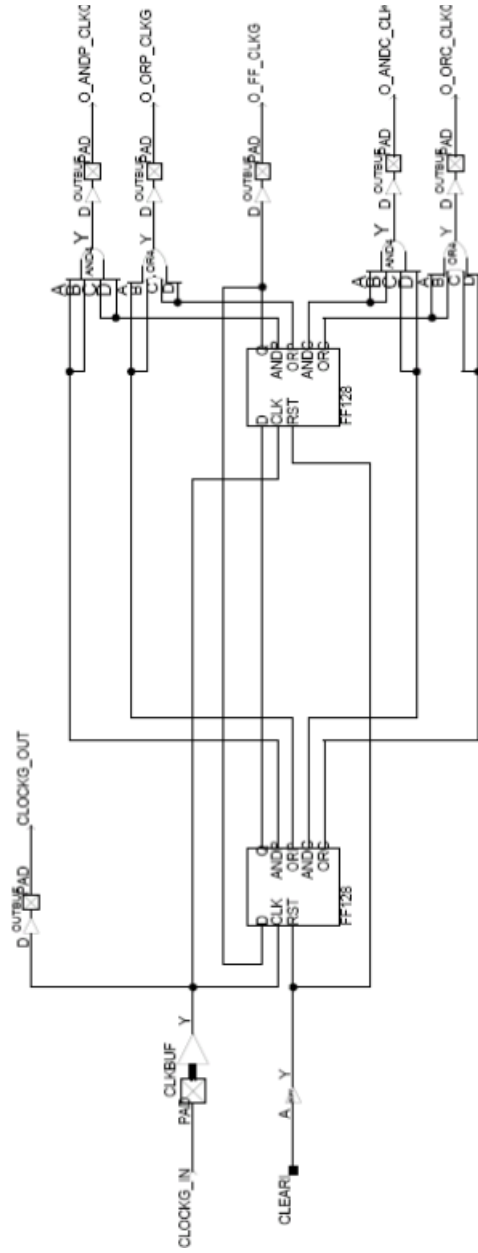

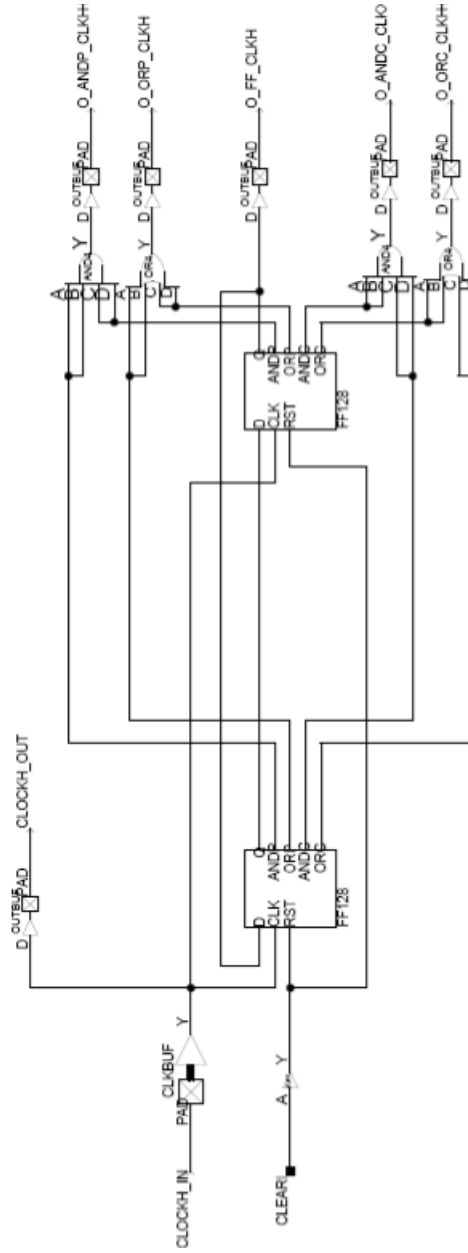

```
// BUFF2p3k.v
`timescale 1 ns/100 ps

module BUFF2p3k (In, Out);

input In;

output Out;

wire x1/*synthesis syn_keep=1 alspreserve=1*/;
wire x2/*synthesis syn_keep=1 alspreserve=1*/;
wire x3/*synthesis syn_keep=1 alspreserve=1*/;
wire x4/*synthesis syn_keep=1 alspreserve=1*/;
wire x5/*synthesis syn_keep=1 alspreserve=1*/;
wire x6/*synthesis syn_keep=1 alspreserve=1*/;
wire x7/*synthesis syn_keep=1 alspreserve=1*/;

BUFF1k buff1k_1 (.In(In), .Out(x1));
BUFF1k buff1k_2 (.In(x1), .Out(x2));
BUFF50 buff3 (.In(x2), .Out(x3));
BUFF50 buff4 (.In(x3), .Out(x4));
BUFF50 buff5 (.In(x4), .Out(x5));
BUFF50 buff6 (.In(x5), .Out(x6));
BUFF50 buff7 (.In(x6), .Out(x7));
BUFF50 buff8 (.In(x7), .Out(Out));

endmodule

// BUFF1k
`timescale 1 ns/100 ps

module BUFF1k (In, Out);

input In;

output Out;

wire x1/*synthesis syn_keep=1 alspreserve=1*/;
wire x2/*synthesis syn_keep=1 alspreserve=1*/;
wire x3/*synthesis syn_keep=1 alspreserve=1*/;
wire x4/*synthesis syn_keep=1 alspreserve=1*/;
wire x5/*synthesis syn_keep=1 alspreserve=1*/;
wire x6/*synthesis syn_keep=1 alspreserve=1*/;
wire x7/*synthesis syn_keep=1 alspreserve=1*/;
wire x8/*synthesis syn_keep=1 alspreserve=1*/;
wire x9/*synthesis syn_keep=1 alspreserve=1*/;
wire x10/*synthesis syn_keep=1 alspreserve=1*/;
wire x11/*synthesis syn_keep=1 alspreserve=1*/;
wire x12/*synthesis syn_keep=1 alspreserve=1*/;
wire x13/*synthesis syn_keep=1 alspreserve=1*/;
wire x14/*synthesis syn_keep=1 alspreserve=1*/;
wire x15/*synthesis syn_keep=1 alspreserve=1*/;
wire x16/*synthesis syn_keep=1 alspreserve=1*/;
wire x17/*synthesis syn_keep=1 alspreserve=1*/;
wire x18/*synthesis syn_keep=1 alspreserve=1*/;
wire x19/*synthesis syn_keep=1 alspreserve=1*/;
```

```
BUFF50 buff1 (.In(In), .Out(x1));
BUFF50 buff2 (.In(x1), .Out(x2));
BUFF50 buff3 (.In(x2), .Out(x3));
BUFF50 buff4 (.In(x3), .Out(x4));
BUFF50 buff5 (.In(x4), .Out(x5));
BUFF50 buff6 (.In(x5), .Out(x6));
BUFF50 buff7 (.In(x6), .Out(x7));
BUFF50 buff8 (.In(x7), .Out(x8));
BUFF50 buff9 (.In(x8), .Out(x9));
BUFF50 buff10 (.In(x9), .Out(x10));
```

```
BUFF50 buff11 (.In(x10), .Out(x11));
BUFF50 buff12 (.In(x11), .Out(x12));
BUFF50 buff13 (.In(x12), .Out(x13));
BUFF50 buff14 (.In(x13), .Out(x14));
BUFF50 buff15 (.In(x14), .Out(x15));
BUFF50 buff16 (.In(x15), .Out(x16));
BUFF50 buff17 (.In(x16), .Out(x17));
BUFF50 buff18 (.In(x17), .Out(x18));
BUFF50 buff19 (.In(x18), .Out(x19));
BUFF50 buff20 (.In(x19), .Out(Out));
```

```
endmodule
```

```
// BUFF50
```

```
`timescale 1 ns/100 ps
```

```
module BUFF50 (In, Out);
```

```
input In;
```

```
output Out;
```

```
wire x1 /*synthesis syn_keep=1 alspreserve=1*/;
wire x2 /*synthesis syn_keep=1 alspreserve=1*/;
wire x3 /*synthesis syn_keep=1 alspreserve=1*/;
wire x4 /*synthesis syn_keep=1 alspreserve=1*/;
wire x5 /*synthesis syn_keep=1 alspreserve=1*/;
wire x6 /*synthesis syn_keep=1 alspreserve=1*/;
wire x7 /*synthesis syn_keep=1 alspreserve=1*/;
wire x8 /*synthesis syn_keep=1 alspreserve=1*/;
wire x9 /*synthesis syn_keep=1 alspreserve=1*/;
wire x10 /*synthesis syn_keep=1 alspreserve=1*/;
wire x11 /*synthesis syn_keep=1 alspreserve=1*/;
wire x12 /*synthesis syn_keep=1 alspreserve=1*/;
wire x13 /*synthesis syn_keep=1 alspreserve=1*/;
wire x14 /*synthesis syn_keep=1 alspreserve=1*/;
wire x15 /*synthesis syn_keep=1 alspreserve=1*/;
wire x16 /*synthesis syn_keep=1 alspreserve=1*/;
wire x17 /*synthesis syn_keep=1 alspreserve=1*/;
wire x18 /*synthesis syn_keep=1 alspreserve=1*/;
wire x19 /*synthesis syn_keep=1 alspreserve=1*/;
wire x20 /*synthesis syn_keep=1 alspreserve=1*/;
wire x21 /*synthesis syn_keep=1 alspreserve=1*/;
wire x22 /*synthesis syn_keep=1 alspreserve=1*/;
```

```
wire x23/*synthesis syn_keep=1 alspreserve=1*/;  
wire x24/*synthesis syn_keep=1 alspreserve=1*/;  
wire x25/*synthesis syn_keep=1 alspreserve=1*/;  
wire x26/*synthesis syn_keep=1 alspreserve=1*/;  
wire x27/*synthesis syn_keep=1 alspreserve=1*/;  
wire x28/*synthesis syn_keep=1 alspreserve=1*/;  
wire x29/*synthesis syn_keep=1 alspreserve=1*/;  
wire x30/*synthesis syn_keep=1 alspreserve=1*/;  
wire x31/*synthesis syn_keep=1 alspreserve=1*/;  
wire x32/*synthesis syn_keep=1 alspreserve=1*/;  
wire x33/*synthesis syn_keep=1 alspreserve=1*/;  
wire x34/*synthesis syn_keep=1 alspreserve=1*/;  
wire x35/*synthesis syn_keep=1 alspreserve=1*/;  
wire x36/*synthesis syn_keep=1 alspreserve=1*/;  
wire x37/*synthesis syn_keep=1 alspreserve=1*/;  
wire x38/*synthesis syn_keep=1 alspreserve=1*/;  
wire x39/*synthesis syn_keep=1 alspreserve=1*/;  
wire x40/*synthesis syn_keep=1 alspreserve=1*/;  
wire x41/*synthesis syn_keep=1 alspreserve=1*/;  
wire x42/*synthesis syn_keep=1 alspreserve=1*/;  
wire x43/*synthesis syn_keep=1 alspreserve=1*/;  
wire x44/*synthesis syn_keep=1 alspreserve=1*/;  
wire x45/*synthesis syn_keep=1 alspreserve=1*/;  
wire x46/*synthesis syn_keep=1 alspreserve=1*/;  
wire x47/*synthesis syn_keep=1 alspreserve=1*/;  
wire x48/*synthesis syn_keep=1 alspreserve=1*/;  
wire x49/*synthesis syn_keep=1 alspreserve=1*/;
```

```
BUFF buff1 (.A(In), .Y(x1));  
BUFF buff2 (.A(x1), .Y(x2));  
BUFF buff3 (.A(x2), .Y(x3));  
BUFF buff4 (.A(x3), .Y(x4));  
BUFF buff5 (.A(x4), .Y(x5));  
BUFF buff6 (.A(x5), .Y(x6));  
BUFF buff7 (.A(x6), .Y(x7));  
BUFF buff8 (.A(x7), .Y(x8));  
BUFF buff9 (.A(x8), .Y(x9));  
BUFF buff10 (.A(x9), .Y(x10));
```

```
BUFF buff11 (.A(x10), .Y(x11));  
BUFF buff12 (.A(x11), .Y(x12));  
BUFF buff13 (.A(x12), .Y(x13));  
BUFF buff14 (.A(x13), .Y(x14));  
BUFF buff15 (.A(x14), .Y(x15));  
BUFF buff16 (.A(x15), .Y(x16));  
BUFF buff17 (.A(x16), .Y(x17));  
BUFF buff18 (.A(x17), .Y(x18));  
BUFF buff19 (.A(x18), .Y(x19));  
BUFF buff20 (.A(x19), .Y(x20));
```

```
BUFF buff21 (.A(x20), .Y(x21));  
BUFF buff22 (.A(x21), .Y(x22));  
BUFF buff23 (.A(x22), .Y(x23));  
BUFF buff24 (.A(x23), .Y(x24));  
BUFF buff25 (.A(x24), .Y(x25));  
BUFF buff26 (.A(x25), .Y(x26));
```

```
BUFF buff27 (.A(x26), .Y(x27));  
BUFF buff28 (.A(x27), .Y(x28));  
BUFF buff29 (.A(x28), .Y(x29));  
BUFF buff30 (.A(x29), .Y(x30));
```

```
BUFF buff31 (.A(x30), .Y(x31));  
BUFF buff32 (.A(x31), .Y(x32));  
BUFF buff33 (.A(x32), .Y(x33));  
BUFF buff34 (.A(x33), .Y(x34));  
BUFF buff35 (.A(x34), .Y(x35));  
BUFF buff36 (.A(x35), .Y(x36));  
BUFF buff37 (.A(x36), .Y(x37));  
BUFF buff38 (.A(x37), .Y(x38));  
BUFF buff39 (.A(x38), .Y(x39));  
BUFF buff40 (.A(x39), .Y(x40));
```

```
BUFF buff41 (.A(x40), .Y(x41));  
BUFF buff42 (.A(x41), .Y(x42));  
BUFF buff43 (.A(x42), .Y(x43));  
BUFF buff44 (.A(x43), .Y(x44));  
BUFF buff45 (.A(x44), .Y(x45));  
BUFF buff46 (.A(x45), .Y(x46));  
BUFF buff47 (.A(x46), .Y(x47));  
BUFF buff48 (.A(x47), .Y(x48));  
BUFF buff49 (.A(x48), .Y(x49));  
BUFF buff50 (.A(x49), .Y(Out));
```

```
endmodule
```

```
// FF128
```

```
`timescale 1 ns/100 ps
```

```
module FF128 (D, Q, CLK, RST, ANDP, ORP, ANDC, ORC);
```

```
input D, CLK, RST;
```

```
output Q, ANDP, ORP, ANDC, ORC;
```

```
wire x1, x2, x3, Q;
```

```
wire andp_a, andp_b, andp_c, andp_d, orp_a, orp_b, orp_c, orp_d;
```

```
wire andc_a, andc_b, andc_c, andc_d, orc_a, orc_b, orc_c, orc_d;
```

```
FF32 dff_a (.D(D), .Q(x1), .CLK(CLK), .RST(RST), .ANDP(andp_a), .ORP(orp_a),  
.ANDC(andc_a), .ORC(orc_a));
```

```
FF32 dff_b (.D(x1), .Q(x2), .CLK(CLK), .RST(RST), .ANDP(andp_b), .ORP(orp_b),  
.ANDC(andc_b), .ORC(orc_b));
```

```
FF32 dff_c (.D(x2), .Q(x3), .CLK(CLK), .RST(RST), .ANDP(andp_c), .ORP(orp_c),  
.ANDC(andc_c), .ORC(orc_c));
```

```
FF32 dff_d (.D(x3), .Q(Q), .CLK(CLK), .RST(RST), .ANDP(andp_d), .ORP(orp_d),  
.ANDC(andc_d), .ORC(orc_d));
```

```
AND4 and4p (.A(andp_a), .B(andp_b), .C(andp_c), .D(andp_d), .Y(ANDP));
```

```
OR4 or4p (.A(orp_a), .B(orp_b), .C(orp_c), .D(orp_d), .Y(ORP));
```

```
AND4 and4c (.A(andc_a), .B(andc_b), .C(andc_c), .D(andc_d), .Y(ANDC));
```



```
OR4 or4c (.A(orc_a), .B(orc_b), .C(orc_c), .D(orc_d), .Y(ORC));

endmodule

// FF32
`timescale 1 ns/100 ps
module FF32 (D, Q, CLK, RST, ANDP, ORP, ANDC, ORC);

input D, CLK, RST;
output Q, ANDP, ORP, ANDC, ORC;

wire x1, x2, x3, Q;
wire andp_a, andp_b, andp_c, andp_d, orp_a, orp_b, orp_c, orp_d;
wire andc_a, andc_b, andc_c, andc_d, orc_a, orc_b, orc_c, orc_d;

FF8 dff_a (.D(D), .Q(x1), .CLK(CLK), .RST(RST), .ANDP(andp_a), .ORP(orp_a),
.ANDC(andc_a), .ORC(orc_a));

FF8 dff_b (.D(x1), .Q(x2), .CLK(CLK), .RST(RST), .ANDP(andp_b), .ORP(orp_b),
.ANDC(andc_b), .ORC(orc_b));

FF8 dff_c (.D(x2), .Q(x3), .CLK(CLK), .RST(RST), .ANDP(andp_c), .ORP(orp_c),
.ANDC(andc_c), .ORC(orc_c));

FF8 dff_d (.D(x3), .Q(Q), .CLK(CLK), .RST(RST), .ANDP(andp_d), .ORP(orp_d),
.ANDC(andc_d), .ORC(orc_d));

AND4 and4p (.A(andp_a), .B(andp_b), .C(andp_c), .D(andp_d), .Y(ANDP));
OR4 or4p (.A(orp_a), .B(orp_b), .C(orp_c), .D(orp_d), .Y(ORP));

AND4 and4c (.A(andc_a), .B(andc_b), .C(andc_c), .D(andc_d), .Y(ANDC));
OR4 or4c (.A(orc_a), .B(orc_b), .C(orc_c), .D(orc_d), .Y(ORC));

endmodule

// FF8
`timescale 1 ns/100 ps

module FF8 (D, Q, CLK, RST, ANDP, ORP, ANDC, ORC);

input D, CLK, RST;
output Q, ANDP, ORP, ANDC, ORC;

wire x1, x2, x3, x4, x5, x6, x7;

DFC1B dff1 (.D(D), .Q(x1), .CLK(CLK), .CLR(RST));
DFP1B dff2 (.D(x1), .Q(x2), .CLK(CLK), .PRE(RST));
DFC1B dff3 (.D(x2), .Q(x3), .CLK(CLK), .CLR(RST));
DFP1B dff4 (.D(x3), .Q(x4), .CLK(CLK), .PRE(RST));
DFC1B dff5 (.D(x4), .Q(x5), .CLK(CLK), .CLR(RST));
DFP1B dff6 (.D(x5), .Q(x6), .CLK(CLK), .PRE(RST));
DFC1B dff7 (.D(x6), .Q(x7), .CLK(CLK), .CLR(RST));
DFP1B dff8 (.D(x7), .Q(Q), .CLK(CLK), .PRE(RST));

AND4 and4p (.A(x2), .B(x4), .C(x6), .D(Q), .Y(ANDP));
OR4 or4p (.A(x2), .B(x4), .C(x6), .D(Q), .Y(ORP));
```

```
AND4 and4c (.A(x1), .B(x3), .C(x5), .D(x7), .Y(ANDC));
OR4 or4c (.A(x1), .B(x3), .C(x5), .D(x7), .Y(ORC));

endmodule

// Top_RAM_Module.v
`timescale 1 ns/100 ps

module Top_RAM_Module(Psel0, Psel1, RC_en, RC_clr, RC_clk, Write, Read, Wclk, Rclk,
    Q_RAM);
input Psel0, Psel1, RC_en, RC_clr, RC_clk, Write, Read, Wclk, Rclk;
output [5:0] Q_RAM;

wire Gnd, Vcc;
wire mx0, mx1;
wire [12:0] rc;
wire [3:0] dec;
wire y_0w, y_0r, y_1w, y_1r, y_2w, y_2r, y_3w, y_3r;
// y_4w, y_4r, y_5w, y_5r, y_6w, y_6r, y_7w, y_7r;
wire [5:0] DIN;
wire [5:0] Q_b0;
wire [5:0] Q_b1;
wire [5:0] Q_b2;
wire [5:0] Q_b3;
//wire [5:0] Q_b4;
//wire [5:0] Q_b5;
//wire [5:0] Q_b6;
//wire [5:0] Q_b7;

GND gnd_0(.Y(Gnd));
VCC vcc_0(.Y(Vcc));

mux_2x1 mux_0(.Data0_port(Gnd), .Data1_port(Vcc), .Sel0(Psel0), .Result(mx0));
mux_2x1 mux_1(.Data0_port(Gnd), .Data1_port(Vcc), .Sel0(Psel1), .Result(mx1));

counter_13 counter_0(.Enable(RC_en), .Aclr(RC_clr), .Clock(RC_clk), .Q(rc));

decoder_2to4 decoder_0(.Data0(rc[11]), .Data1(rc[12]), .Eq(dec));

NAND2 nand_0w(.A(dec[0]), .B(Write), .Y(y_0w));
NAND2 nand_0r(.A(dec[0]), .B(Read), .Y(y_0r));

ram_2048x6 ram_blk0(.Data(DIN), .Q(Q_b0), .WAddress(rc[10:0]), .RAddress(rc[10:0]),
    .WE(y_0w), .RE(y_0r), .WClock(Wclk), .RClock(Rclk));

assign DIN[0]=mx0, DIN[1]=mx1, DIN[2]=mx0, DIN[3]=mx1, DIN[4]=mx0, DIN[5]=mx1;

NAND2 nand_1w(.A(dec[1]), .B(Write), .Y(y_1w));
NAND2 nand_1r(.A(dec[1]), .B(Read), .Y(y_1r));

ram_2048x6 ram_blk1(.Data(DIN), .Q(Q_b1), .WAddress(rc[10:0]), .RAddress(rc[10:0]),
    .WE(y_1w), .RE(y_1r), .WClock(Wclk), .RClock(Rclk));

NAND2 nand_2w(.A(dec[2]), .B(Write), .Y(y_2w));
NAND2 nand_2r(.A(dec[2]), .B(Read), .Y(y_2r));
```

```
ram_2048x6 ram_blk2(.Data(DIN),
    .Q(Q_b2), .WAddress(rc[10:0]), .RAddress(rc[10:0]),
    .WE(y_2w), .RE(y_2r), .WClock(Wclk), .RClock(Rclk));

NAND2 nand_3w(.A(dec[3]), .B(Write), .Y(y_3w));
NAND2 nand_3r(.A(dec[3]), .B(Read), .Y(y_3r));

ram_2048x6 ram_blk3(.Data(DIN),
    .Q(Q_b3), .WAddress(rc[10:0]), .RAddress(rc[10:0]),
    .WE(y_3w), .RE(y_3r), .WClock(Wclk), .RClock(Rclk));

/* NAND2 nand_4w(.A(dec[4]), .B(Write), .Y(y_4w));
NAND2 nand_4r(.A(dec[4]), .B(Read), .Y(y_4r));

ram_2048x3 ram_blk4(.Data(DIN),
    .Q(Q_b4), .WAddress(rc[10:0]), .RAddress(rc[10:0]),
    .WE(y_4w), .RE(y_4r), .WClock(Wclk), .RClock(Rclk));

NAND2 nand_5w(.A(dec[5]), .B(Write), .Y(y_5w));
NAND2 nand_5r(.A(dec[5]), .B(Read), .Y(y_5r));

ram_2048x3 ram_blk5(.Data(DIN),
    .Q(Q_b5), .WAddress(rc[10:0]), .RAddress(rc[10:0]),
    .WE(y_5w), .RE(y_5r), .WClock(Wclk), .RClock(Rclk));

NAND2 nand_6w(.A(dec[6]), .B(Write), .Y(y_6w));
NAND2 nand_6r(.A(dec[6]), .B(Read), .Y(y_6r));

ram_2048x3 ram_blk6(.Data(DIN),
    .Q(Q_b6), .WAddress(rc[10:0]), .RAddress(rc[10:0]),
    .WE(y_6w), .RE(y_6r), .WClock(Wclk), .RClock(Rclk));

NAND2 nand_7w(.A(dec[7]), .B(Write), .Y(y_7w));
NAND2 nand_7r(.A(dec[7]), .B(Read), .Y(y_7r));

ram_2048x3 ram_blk7(.Data(DIN),
    .Q(Q_b7), .WAddress(rc[10:0]), .RAddress(rc[10:0]),
    .WE(y_7w), .RE(y_7r), .WClock(Wclk), .RClock(Rclk)); */

mux_6x4 mux_6x4_0(.Data0_port(Q_b0), .Data1_port(Q_b1), .Data2_port(Q_b2),
    .Data3_port(Q_b3), .Sel0(rc[11]),
    .Sel1(rc[12]), .Result(Q_RAM));

endmodule
```

```
`timescale 1 ns/100 ps
// Version: 6.0 SP3 6.0.30.3
```

```
module mux_2x1(Data0_port,Data1_port,Sel0,Result);
input Data0_port, Data1_port, Sel0;
output Result;

    MX2 MX2_Result(.A(Data0_port), .B(Data1_port), .S(Sel0), .Y(
        Result));
```

```
endmodule
```

```
`timescale 1 ns/100 ps
// Version: 6.2 SP2 6.2.52.7
```

```
module counter_13(Enable,Aclr,Clock,Q);
input Enable, Aclr, Clock;
output [12:0] Q;

    wire ClrAux_0_net, ClrAux_7_net, MX2_1_Y, MX2_7_Y, MX2_4_Y,
        CM8_0_Y, MX2_10_Y, MX2_9_Y, MX2_3_Y, MX2_5_Y, MX2_6_Y,
        MX2_0_Y, MX2_8_Y, MX2_2_Y, MX2_11_Y, VCC, GND;

    VCC VCC_1_net(.Y(VCC));
    GND GND_1_net(.Y(GND));
    DFC1D DFC1D_Q_7_inst(.D(MX2_1_Y), .CLK(Q[6]), .CLR(
        ClrAux_7_net), .Q(Q[7]));
    DFC1D DFC1D_Q_1_inst(.D(MX2_7_Y), .CLK(Q[0]), .CLR(
        ClrAux_0_net), .Q(Q[1]));
    BUFF BUFF_ClrAux_0_inst(.A(Aclr), .Y(ClrAux_0_net));
    MX2 MX2_9(.A(VCC), .B(GND), .S(Q[5]), .Y(MX2_9_Y));
    DFC1D DFC1D_Q_2_inst(.D(MX2_6_Y), .CLK(Q[1]), .CLR(
        ClrAux_0_net), .Q(Q[2]));
    MX2 MX2_0(.A(VCC), .B(GND), .S(Q[8]), .Y(MX2_0_Y));
    DFC1D DFC1D_Q_12_inst(.D(MX2_4_Y), .CLK(Q[11]), .CLR(
        ClrAux_7_net), .Q(Q[12]));
    DFC1D DFC1D_Q_3_inst(.D(MX2_11_Y), .CLK(Q[2]), .CLR(
        ClrAux_0_net), .Q(Q[3]));
    DFC1D DFC1D_Q_4_inst(.D(MX2_5_Y), .CLK(Q[3]), .CLR(
        ClrAux_0_net), .Q(Q[4]));
    CM8 CM8_0(.D0(GND), .D1(VCC), .D2(VCC), .D3(GND), .S00(Q[0]),
        .S01(VCC), .S10(Enable), .S11(GND), .Y(CM8_0_Y));
    MX2 MX2_11(.A(VCC), .B(GND), .S(Q[3]), .Y(MX2_11_Y));
    DFC1B DFC1B_Q_0_inst(.D(CM8_0_Y), .CLK(Clock), .CLR(
        ClrAux_0_net), .Q(Q[0]));
    MX2 MX2_6(.A(VCC), .B(GND), .S(Q[2]), .Y(MX2_6_Y));
    MX2 MX2_3(.A(VCC), .B(GND), .S(Q[10]), .Y(MX2_3_Y));
    DFC1D DFC1D_Q_11_inst(.D(MX2_10_Y), .CLK(Q[10]), .CLR(
        ClrAux_7_net), .Q(Q[11]));
    MX2 MX2_10(.A(VCC), .B(GND), .S(Q[11]), .Y(MX2_10_Y));
    BUFF BUFF_ClrAux_7_inst(.A(Aclr), .Y(ClrAux_7_net));
    MX2 MX2_4(.A(VCC), .B(GND), .S(Q[12]), .Y(MX2_4_Y));
    DFC1D DFC1D_Q_5_inst(.D(MX2_9_Y), .CLK(Q[4]), .CLR(
```

```

    ClrAux_0_net), .Q(Q[5]));
DFC1D DFC1D_Q_9_inst(.D(MX2_8_Y), .CLK(Q[8]), .CLR(
    ClrAux_7_net), .Q(Q[9]));
MX2 MX2_5(.A(VCC), .B(GND), .S(Q[4]), .Y(MX2_5_Y));
MX2 MX2_8(.A(VCC), .B(GND), .S(Q[9]), .Y(MX2_8_Y));
DFC1D DFC1D_Q_8_inst(.D(MX2_0_Y), .CLK(Q[7]), .CLR(
    ClrAux_7_net), .Q(Q[8]));
MX2 MX2_2(.A(VCC), .B(GND), .S(Q[6]), .Y(MX2_2_Y));
MX2 MX2_7(.A(VCC), .B(GND), .S(Q[1]), .Y(MX2_7_Y));
MX2 MX2_1(.A(VCC), .B(GND), .S(Q[7]), .Y(MX2_1_Y));
DFC1D DFC1D_Q_6_inst(.D(MX2_2_Y), .CLK(Q[5]), .CLR(
    ClrAux_0_net), .Q(Q[6]));
DFC1D DFC1D_Q_10_inst(.D(MX2_3_Y), .CLK(Q[9]), .CLR(
    ClrAux_7_net), .Q(Q[10]));

endmodule

`timescale 1 ns/100 ps
// Version: 6.2 SP2 6.2.52.7

module decoder_2to4(Data0,Data1,Eq);
input Data0, Data1;
output [3:0] Eq;

    AND2A AND2A_Eq_1_inst(.A(Data1), .B(Data0), .Y(Eq[1]));
    AND2 AND2_Eq_3_inst(.A(Data0), .B(Data1), .Y(Eq[3]));
    AND2A AND2A_Eq_2_inst(.A(Data0), .B(Data1), .Y(Eq[2]));
    AND2B AND2B_Eq_0_inst(.A(Data0), .B(Data1), .Y(Eq[0]));

endmodule

`timescale 1 ns/100 ps
// Version: 6.2 SP2 6.2.52.7

module ram_2048x6(Data,Q,WAddress,RAddress,WE,RE,WClock,RClock);
input [5:0] Data;
output [5:0] Q;
input [10:0] WAddress, RAddress;
input WE, RE, WClock, RClock;

    wire WEP, REP, VCC, GND;

    VCC VCC_1_net(.Y(VCC));
    GND GND_1_net(.Y(GND));
    RAM64K36P ram_2048x6_R0C2(.WCLK(WClock), .RCLK(RClock),
        .DEPTH0(GND), .DEPTH1(GND), .DEPTH2(GND), .DEPTH3(GND),
        .WEN(WEP), .WW0(VCC), .WW1(GND), .WW2(GND), .WRAD0(
        WAddress[0]), .WRAD1(WAddress[1]), .WRAD2(WAddress[2]),
        .WRAD3(WAddress[3]), .WRAD4(WAddress[4]), .WRAD5(
        WAddress[5]), .WRAD6(WAddress[6]), .WRAD7(WAddress[7]),
        .WRAD8(WAddress[8]), .WRAD9(WAddress[9]), .WRAD10(
        WAddress[10]), .WRAD11(GND), .WRAD12(GND), .WRAD13(GND),
        .WRAD14(GND), .WRAD15(GND), .WD0(Data[4]), .WD1(Data[5]),

```

```
.WD2(GND), .WD3(GND), .WD4(GND), .WD5(GND), .WD6(GND),  
.WD7(GND), .WD8(GND), .WD9(GND), .WD10(GND), .WD11(GND),  
.WD12(GND), .WD13(GND), .WD14(GND), .WD15(GND), .WD16(GND)  
, .WD17(GND), .WD18(GND), .WD19(GND), .WD20(GND), .WD21(  
GND), .WD22(GND), .WD23(GND), .WD24(GND), .WD25(GND),  
.WD26(GND), .WD27(GND), .WD28(GND), .WD29(GND), .WD30(GND)  
, .WD31(GND), .WD32(GND), .WD33(GND), .WD34(GND), .WD35(  
GND), .REN(REP), .RW0(VCC), .RW1(GND), .RW2(GND), .RDAD0(  
RAddress[0]), .RDAD1(RAddress[1]), .RDAD2(RAddress[2]),  
.RDAD3(RAddress[3]), .RDAD4(RAddress[4]), .RDAD5(  
RAddress[5]), .RDAD6(RAddress[6]), .RDAD7(RAddress[7]),  
.RDAD8(RAddress[8]), .RDAD9(RAddress[9]), .RDAD10(  
RAddress[10]), .RDAD11(GND), .RDAD12(GND), .RDAD13(GND),  
.RDAD14(GND), .RDAD15(GND), .RD0(Q[4]), .RD1(Q[5]), .RD2(  
, .RD3(), .RD4(), .RD5(), .RD6(), .RD7(), .RD8(), .RD9(),  
.RD10(), .RD11(), .RD12(), .RD13(), .RD14(), .RD15(),  
.RD16(), .RD17(), .RD18(), .RD19(), .RD20(), .RD21(),  
.RD22(), .RD23(), .RD24(), .RD25(), .RD26(), .RD27(),  
.RD28(), .RD29(), .RD30(), .RD31(), .RD32(), .RD33(),  
.RD34(), .RD35());  
INV REBUBBLE(.A(RE), .Y(REP));  
INV WEBUBBLE(.A(WE), .Y(WEP));  
RAM64K36P ram_2048x6_R0C1(.WCLK(WClock), .RCLK(RClock),  
.DEPTH0(GND), .DEPTH1(GND), .DEPTH2(GND), .DEPTH3(GND),  
.WEN(WEP), .WW0(VCC), .WW1(GND), .WW2(GND), .WRAD0(  
WAddress[0]), .WRAD1(WAddress[1]), .WRAD2(WAddress[2]),  
.WRAD3(WAddress[3]), .WRAD4(WAddress[4]), .WRAD5(  
WAddress[5]), .WRAD6(WAddress[6]), .WRAD7(WAddress[7]),  
.WRAD8(WAddress[8]), .WRAD9(WAddress[9]), .WRAD10(  
WAddress[10]), .WRAD11(GND), .WRAD12(GND), .WRAD13(GND),  
.WRAD14(GND), .WRAD15(GND), .WD0(Data[2]), .WD1(Data[3]),  
.WD2(GND), .WD3(GND), .WD4(GND), .WD5(GND), .WD6(GND),  
.WD7(GND), .WD8(GND), .WD9(GND), .WD10(GND), .WD11(GND),  
.WD12(GND), .WD13(GND), .WD14(GND), .WD15(GND), .WD16(GND)  
, .WD17(GND), .WD18(GND), .WD19(GND), .WD20(GND), .WD21(  
GND), .WD22(GND), .WD23(GND), .WD24(GND), .WD25(GND),  
.WD26(GND), .WD27(GND), .WD28(GND), .WD29(GND), .WD30(GND)  
, .WD31(GND), .WD32(GND), .WD33(GND), .WD34(GND), .WD35(  
GND), .REN(REP), .RW0(VCC), .RW1(GND), .RW2(GND), .RDAD0(  
RAddress[0]), .RDAD1(RAddress[1]), .RDAD2(RAddress[2]),  
.RDAD3(RAddress[3]), .RDAD4(RAddress[4]), .RDAD5(  
RAddress[5]), .RDAD6(RAddress[6]), .RDAD7(RAddress[7]),  
.RDAD8(RAddress[8]), .RDAD9(RAddress[9]), .RDAD10(  
RAddress[10]), .RDAD11(GND), .RDAD12(GND), .RDAD13(GND),  
.RDAD14(GND), .RDAD15(GND), .RD0(Q[2]), .RD1(Q[3]), .RD2(  
, .RD3(), .RD4(), .RD5(), .RD6(), .RD7(), .RD8(), .RD9(),  
.RD10(), .RD11(), .RD12(), .RD13(), .RD14(), .RD15(),  
.RD16(), .RD17(), .RD18(), .RD19(), .RD20(), .RD21(),  
.RD22(), .RD23(), .RD24(), .RD25(), .RD26(), .RD27(),  
.RD28(), .RD29(), .RD30(), .RD31(), .RD32(), .RD33(),  
.RD34(), .RD35());  
RAM64K36P ram_2048x6_R0C0(.WCLK(WClock), .RCLK(RClock),  
.DEPTH0(GND), .DEPTH1(GND), .DEPTH2(GND), .DEPTH3(GND),  
.WEN(WEP), .WW0(VCC), .WW1(GND), .WW2(GND), .WRAD0(  
WAddress[0]), .WRAD1(WAddress[1]), .WRAD2(WAddress[2]),  
.WRAD3(WAddress[3]), .WRAD4(WAddress[4]), .WRAD5(  
WAddress[5]), .WRAD6(WAddress[6]), .WRAD7(WAddress[7]),  
.WRAD8(WAddress[8]), .WRAD9(WAddress[9]), .WRAD10(  
WAddress[10]), .WRAD11(GND), .WRAD12(GND), .WRAD13(GND),  
.WRAD14(GND), .WRAD15(GND), .WD0(Data[2]), .WD1(Data[3]),  
.WD2(GND), .WD3(GND), .WD4(GND), .WD5(GND), .WD6(GND),  
.WD7(GND), .WD8(GND), .WD9(GND), .WD10(GND), .WD11(GND),  
.WD12(GND), .WD13(GND), .WD14(GND), .WD15(GND), .WD16(GND)  
, .WD17(GND), .WD18(GND), .WD19(GND), .WD20(GND), .WD21(  
GND), .WD22(GND), .WD23(GND), .WD24(GND), .WD25(GND),  
.WD26(GND), .WD27(GND), .WD28(GND), .WD29(GND), .WD30(GND)  
, .WD31(GND), .WD32(GND), .WD33(GND), .WD34(GND), .WD35(  
GND), .REN(REP), .RW0(VCC), .RW1(GND), .RW2(GND), .RDAD0(  
RAddress[0]), .RDAD1(RAddress[1]), .RDAD2(RAddress[2]),  
.RDAD3(RAddress[3]), .RDAD4(RAddress[4]), .RDAD5(  
RAddress[5]), .RDAD6(RAddress[6]), .RDAD7(RAddress[7]),  
.RDAD8(RAddress[8]), .RDAD9(RAddress[9]), .RDAD10(  
RAddress[10]), .RDAD11(GND), .RDAD12(GND), .RDAD13(GND),  
.RDAD14(GND), .RDAD15(GND), .RD0(Q[2]), .RD1(Q[3]), .RD2(  
, .RD3(), .RD4(), .RD5(), .RD6(), .RD7(), .RD8(), .RD9(),  
.RD10(), .RD11(), .RD12(), .RD13(), .RD14(), .RD15(),  
.RD16(), .RD17(), .RD18(), .RD19(), .RD20(), .RD21(),  
.RD22(), .RD23(), .RD24(), .RD25(), .RD26(), .RD27(),  
.RD28(), .RD29(), .RD30(), .RD31(), .RD32(), .RD33(),  
.RD34(), .RD35());
```

```
WAddress[5]), .WRAD6(WAddress[6]), .WRAD7(WAddress[7]),
.WRAD8(WAddress[8]), .WRAD9(WAddress[9]), .WRAD10(
WAddress[10]), .WRAD11(GND), .WRAD12(GND), .WRAD13(GND),
.WRAD14(GND), .WRAD15(GND), .WD0(Data[0]), .WD1(Data[1]),
.WD2(GND), .WD3(GND), .WD4(GND), .WD5(GND), .WD6(GND),
.WD7(GND), .WD8(GND), .WD9(GND), .WD10(GND), .WD11(GND),
.WD12(GND), .WD13(GND), .WD14(GND), .WD15(GND), .WD16(GND)
, .WD17(GND), .WD18(GND), .WD19(GND), .WD20(GND), .WD21(
GND), .WD22(GND), .WD23(GND), .WD24(GND), .WD25(GND),
.WD26(GND), .WD27(GND), .WD28(GND), .WD29(GND), .WD30(GND)
, .WD31(GND), .WD32(GND), .WD33(GND), .WD34(GND), .WD35(
GND), .REN(REP), .RW0(VCC), .RW1(GND), .RW2(GND), .RDAD0(
RAddress[0]), .RDAD1(RAddress[1]), .RDAD2(RAddress[2]),
.RDAD3(RAddress[3]), .RDAD4(RAddress[4]), .RDAD5(
RAddress[5]), .RDAD6(RAddress[6]), .RDAD7(RAddress[7]),
.RDAD8(RAddress[8]), .RDAD9(RAddress[9]), .RDAD10(
RAddress[10]), .RDAD11(GND), .RDAD12(GND), .RDAD13(GND),
.RDAD14(GND), .RDAD15(GND), .RD0(Q[0]), .RD1(Q[1]), .RD2()
, .RD3(), .RD4(), .RD5(), .RD6(), .RD7(), .RD8(), .RD9(),
.RD10(), .RD11(), .RD12(), .RD13(), .RD14(), .RD15(),
.RD16(), .RD17(), .RD18(), .RD19(), .RD20(), .RD21(),
.RD22(), .RD23(), .RD24(), .RD25(), .RD26(), .RD27(),
.RD28(), .RD29(), .RD30(), .RD31(), .RD32(), .RD33(),
.RD34(), .RD35());
```

```
endmodule
```

```
`timescale 1 ns/100 ps
```

```
// Version: 6.2 SP2 6.2.52.7
```

```
module mux_6x4(Data0_port,Data1_port,Data2_port,Data3_port,Sel0,
Sel1,Result);
```

```
input [5:0] Data0_port, Data1_port, Data2_port, Data3_port;
```

```
input Sel0, Sel1;
```

```
output [5:0] Result;
```

```
MX4 MX4_Result_0_inst(.D0(Data0_port[0]), .D1(Data1_port[0]),
.D2(Data2_port[0]), .D3(Data3_port[0]), .S0(Sel0), .S1(
Sel1), .Y(Result[0]));
```

```
MX4 MX4_Result_2_inst(.D0(Data0_port[2]), .D1(Data1_port[2]),
.D2(Data2_port[2]), .D3(Data3_port[2]), .S0(Sel0), .S1(
Sel1), .Y(Result[2]));
```

```
MX4 MX4_Result_5_inst(.D0(Data0_port[5]), .D1(Data1_port[5]),
.D2(Data2_port[5]), .D3(Data3_port[5]), .S0(Sel0), .S1(
Sel1), .Y(Result[5]));
```

```
MX4 MX4_Result_1_inst(.D0(Data0_port[1]), .D1(Data1_port[1]),
.D2(Data2_port[1]), .D3(Data3_port[1]), .S0(Sel0), .S1(
Sel1), .Y(Result[1]));
```

```
MX4 MX4_Result_4_inst(.D0(Data0_port[4]), .D1(Data1_port[4]),
.D2(Data2_port[4]), .D3(Data3_port[4]), .S0(Sel0), .S1(
Sel1), .Y(Result[4]));
```

```
MX4 MX4_Result_3_inst(.D0(Data0_port[3]), .D1(Data1_port[3]),
.D2(Data2_port[3]), .D3(Data3_port[3]), .S0(Sel0), .S1(
Sel1), .Y(Result[3]));
```

```
endmodule
```



Microsemi Corporate Headquarters
One Enterprise, Aliso Viejo CA 92656 USA
Within the USA: +1 (949) 380-6100
Sales: +1 (949) 380-6136
Fax: +1 (949) 215-4996

Microsemi Corporation (NASDAQ: MSCC) offers a comprehensive portfolio of semiconductor solutions for: aerospace, defense and security; enterprise and communications; and industrial and alternative energy markets. Products include high-performance, high-reliability analog and RF devices, mixed signal and RF integrated circuits, customizable SoCs, FPGAs, and complete subsystems. Microsemi is headquartered in Aliso Viejo, Calif. Learn more at www.microsemi.com.

© 2013 Microsemi Corporation. All rights reserved. Microsemi and the Microsemi logo are trademarks of Microsemi Corporation. All other trademarks and service marks are the property of their respective owners.