

## TOTAL IONIZING DOSE TEST REPORT

No. 10T-RTAX2000S-D477A1

May 28, 2010

J.J. Wang

(650) 318-4576

[jih-jong.wang@actel.com](mailto:jih-jong.wang@actel.com)

### I. SUMMARY TABLE

Parameter	Tolerance
1. Gross Functionality	Passed 300 krad(SiO <sub>2</sub> )
2. Power Supply Current (I <sub>CCA</sub> /I <sub>CCI</sub> )	Passed 200 krad(SiO <sub>2</sub> )
3. Input Threshold (V <sub>TH</sub> /V <sub>IH</sub> )	Passed 300 krad(SiO <sub>2</sub> )
4. Output Drive (V <sub>OL</sub> /V <sub>OH</sub> )	Passed 300 krad(SiO <sub>2</sub> )
5. Propagation Delay	Passed 300 krad(SiO <sub>2</sub> ) for 10% degradation criterion
6. Transition Characteristics	Passed 300 krad(SiO <sub>2</sub> )

### II. TOTAL IONIZING DOSE (TID) TESTING

This testing is designed on the base of an extensive database (see TID data of antifuse-based FPGA in <http://www.klabs.org/> and <http://www.actel.com/>) accumulated from the TID testing of many generations of antifuse-based FPGAs.

#### A. Device-Under-Test (DUT) and Irradiation Parameters

Table 1 lists the DUT and irradiation parameters. During irradiation each input and most of the output is grounded through a 100k-ohm resistor; during annealing each input or output is tied to the ground or V<sub>CC1</sub> with a 2.7 k ohm resistor. Appendix A and B contains the schematics of the irradiation-bias circuit.

Table 1 DUT and Irradiation Parameters

Part Number	RTAX2000S
Package	CQFP352
Foundry	United Microelectronics Corp.
Technology	0.15 μm CMOS
DUT Design	TOP_AX2000S_TID
Die Lot Number	D477A1
Quantity Tested	6
Serial Number	100 krad(SiO <sub>2</sub> ): 4148,4149 200 krad(SiO <sub>2</sub> ): 4142,4146 300 krad(SiO <sub>2</sub> ): 4139, 4140
Radiation Facility	Defense Microelectronics Activity
Radiation Source	Co-60
Dose Rate (±5%)	5 krad(SiO <sub>2</sub> )/min
Irradiation Temperature	Room
Irradiation and Measurement Bias (V <sub>CC1</sub> /V <sub>CCA</sub> )	Static at 3.3 V/1.5 V
IO Configuration	Single ended: LVTTTL Differential pair: LVPECL

## B. Test Method

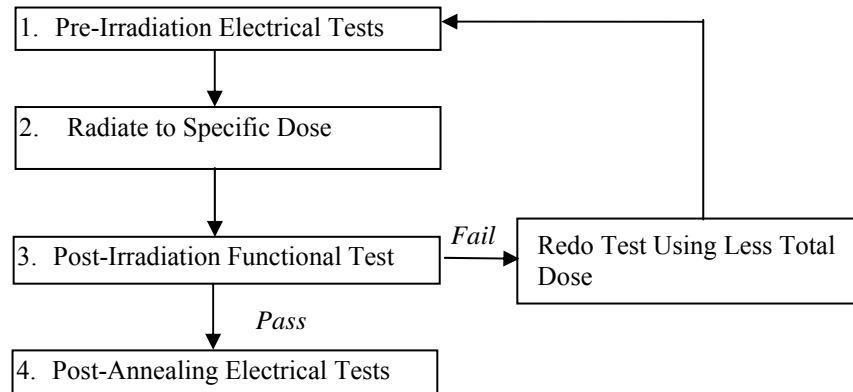

Figure 1 Parametric test flow chart

The test method generally follows the guidelines in the military standard TM1019. Figure 1 is the flow chart describing the steps for functional and parametric tests, irradiation, and post-irradiation annealing.

The accelerated aging, or rebound test mentioned in TM1019 is unnecessary because there is no adverse time-dependent effect (TDE) in Actel products manufactured by deep sub-micron CMOS technologies. Elevated temperature annealing basically reduces the effects originating from radiation-induced leakage currents. As indicated by test data in the following sections, the predominant radiation effects in RTAX2000S are due to radiation-induced leakage currents.

Room temperature annealing is performed in this test; the duration is approximately 6 days.

## C. Design and Parametric Measurements

The DUT uses a high utilization, generic design (TOP\_AX2000S\_TID) to evaluate total dose effects for typical space applications. Appendix B contains the schematics and Verilog files of this design.

Table 2 lists measured electrical parameters and the corresponding logic design. The functionality is measured on the output pin (O\_BS) of a combinational buffer-string with 14,000 buffers, output pins (O\_ANDP\_CLKF, O\_ORP\_CLKF, O\_FF\_CLKF, O\_ANDC\_CLKF, O\_ORC\_CLKF, O\_ANDP\_CLKG, O\_ORP\_CLKG, O\_FF\_CLKG, O\_ANDC\_CLKG, O\_ORC\_CLKG, O\_ANDP\_CLKH, O\_ORP\_CLKH, O\_FF\_CLKH, O\_ANDC\_CLKH, O\_ORC\_CLKH, O\_ANDP\_HCLKA, O\_ORP\_HCLKA, O\_FF\_HCLKA, O\_ANDC\_HCLKA, and O\_ORC\_HCLKA) of four (4) shift registers with 10,728 bits total, and half of the output pins (OUTX0, OUTX1, OUTX2, OUTX3, OUTX4, OUTX5, OUTX6 and OUTX7) of the embedded RAM configured as 16K×16.

$I_{CC}$  is measured on the power supply of the logic-array ( $I_{CCA}$ ) and I/O ( $I_{CCI}$ ) respectively. The input logic threshold ( $V_{IL}/V_{IH}$ ) is measured on single-ended inputs EN8, DA, IO\_I1, IO\_I2, IO\_I3, IO\_I4, IO\_I5 and IO\_I6, and also on differential inputs DIO\_I1P, DIO\_I2P, DIO\_I3P, DIO\_I4P, DIO\_I5P, DIO\_I6P and DIO\_I7P. The differential inputs are configured as LVPECL instead of LVDS because LVPECL, using 3.3 VDC, is worse than LVDS, which uses 2.5 VDC. During the measurement on the differential inputs, the N (negative) side of the differential pair is biased at 1.8 V. The output-drive voltage ( $V_{OL}/V_{OH}$ ) is measured on QA0 and YQ0. The propagation delay is measured on the output (O\_BS) of the buffer string; the definition is the time delay from the triggering edge at the CLOCK input to the switching edge at the output O\_BS. Both the delays of low-to-high and high-to-low output transitions are measured; the reported delay is the average of these two measurements. The transition characteristics, measured on the output O\_BS, are shown as oscilloscope captures.

Table 2 Logic Design for Parametric Measurements

Parameters	Logic Design
1. Functionality	All key logic functions (O_BS, O_ANDP_CLKF, O_ORP_CLKF, O_FF_CLKF, O_ANDC_CLKF, O_ORC_CLKF, O_ANDP_CLKG, O_ORP_CLKG, O_FF_CLKG, O_ANDC_CLKG, O_ORC_CLKG, O_ANDP_CLKH, O_ORP_CLKH, O_FF_CLKH, O_ANDC_CLKH, O_ORC_CLKH, O_ANDP_HCLKA, O_ORP_HCLKA, O_FF_HCLKA, O_ANDC_HCLKA, and O_ORC_HCLKA), and outputs of embedded RAM (OUTX0, OUTX1, OUTX2, OUTX3, OUTX4, OUTX5, OUTX6 and OUTX7)
2. $I_{CC}$ ( $I_{CCA}/I_{CCI}$ )	DUT power supply
3. Input Threshold ( $V_{IL}/V_{IH}$ )	Single ended inputs (EN8/YQ0, DA/QA0, IO_I1/IO_O1, IO_I2/IO_O2, IO_I3/IO_O3, IO_I4/IO_O4, IO_I5/IO_O5, IO_I6/IO_O6), and differential inputs (DIO_I1P/DIO_O1, DIO_I2P/DIO_O2, DIO_I3P/DIO_O3, DIO_I4P/DIO_O4, DIO_I5P/DIO_O5, DIO_I6P/DIO_O6, DIO_I7P/DIO_O7)
4. Output Drive ( $V_{OL}/V_{OH}$ )	Output buffer (EN8/YQ0, DA/QA0)
5. Propagation Delay	String of buffers (CLOCK to O_BS)
6. Transition Characteristic	String of buffers output (O_BS)

### III. TEST RESULTS

#### A. Functionality

Every DUT passed the pre-irradiation and post-annealing functional tests. The as-irradiated DUT is functionally tested on the output (O\_FF\_HCLKA) of the largest shift register.

#### B. Power Supply Current ( $I_{CCA}$ and $I_{CCI}$ )

Figures 2-7 plots the in-flux standby  $I_{CCA}$  and  $I_{CCI}$  versus total dose for each DUT. Table 3 summarizes the pre-irradiation, post-irradiation and post-annealing  $I_{CC}$ . The post-annealing  $I_{CC}$  for four different bit patterns, all '0', all '1', checkerboard and inverted-checkerboard, in the RAM are basically the same.

Table 3 Pre-irradiation, Post Irradiation and Post-Annealing  $I_{CC}$

DUT	Total Dose krad(SiO <sub>2</sub> )	$I_{CCA}$ (mA)			$I_{CCI}$ (mA)		
		Pre-irrad	Post-irrad	Post-ann	Pre-irrad	Post-irrad	Post-ann
4139	300krad	10.5	60.6	11	27.8	162	70
4140	300krad	8.2	63.4	16	27.7	151	65
4142	200krad	10	14.1	12	29	65.7	47
4146	200krad	9.2	8.5	10	26.7	70.8	44
4148	100krad	5.5	4.8	4	26	27.8	27
4149	100krad	9.5	10.4	10	27.4	29	28

In compliance with TM1019.6 subsection 3.11.2.c, the post-irradiation-parametric limit (PIPL) for the post-annealing  $I_{CCI}$  in this test is defined as the addition of highest  $I_{CCI}$ ,  $I_{CCDA}$  and  $I_{CCDIFFA}$  values in Table 2-4 of the RTAXS spec sheet:

[http://www.actel.com/documents/RTAXS\\_DS.pdf](http://www.actel.com/documents/RTAXS_DS.pdf)

For  $I_{CCA}$ , the PIPL is 500 mA; the PIPL of  $I_{CCI}$  equals to  $35+10+3.13 \times 7 = 66.91$ (mA). Note that there are 7 pairs of differential LVPECL inputs in each DUT. Based on these PIPL, post-annealed DUT passes both the  $I_{CCA}$  and  $I_{CCI}$  spec for 200 krad(SiO<sub>2</sub>).

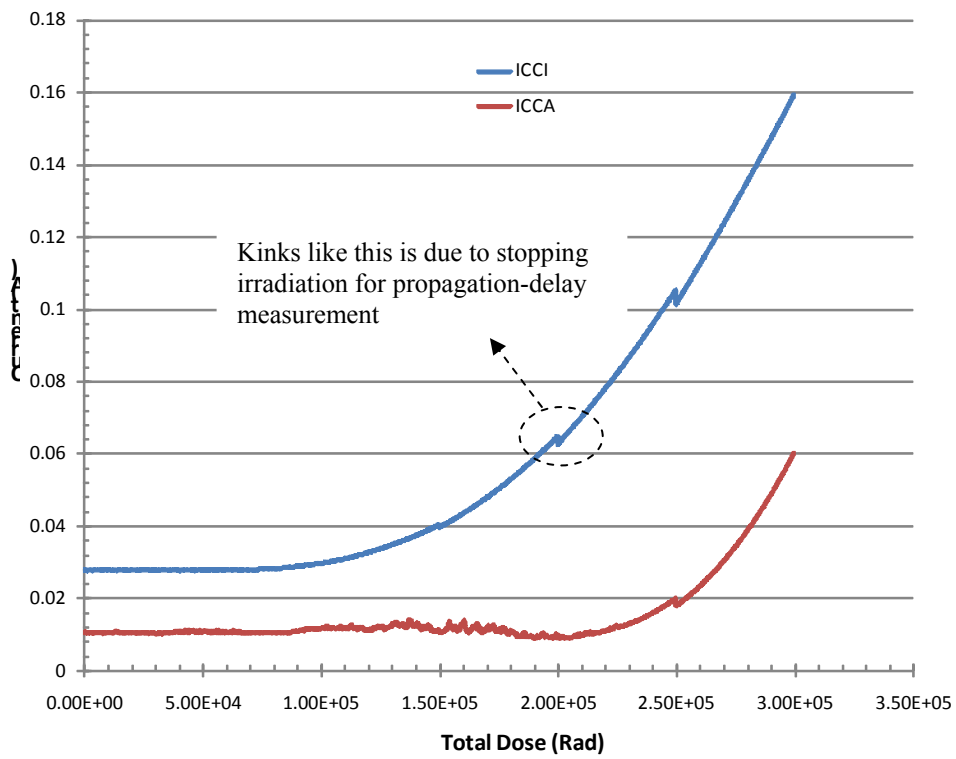

Figure 2 DUT 4139 in-flux  $I_{CCA}$  and  $I_{CCI}$ .

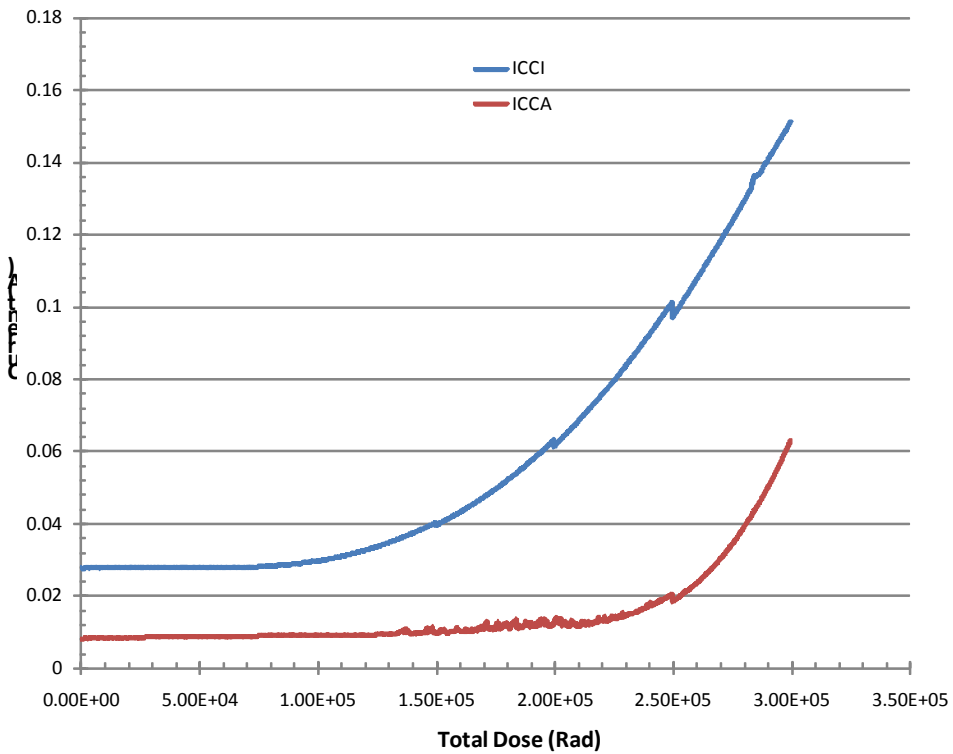

Figure 3 DUT 4140 in-flux  $I_{CCA}$  and  $I_{CCI}$ .

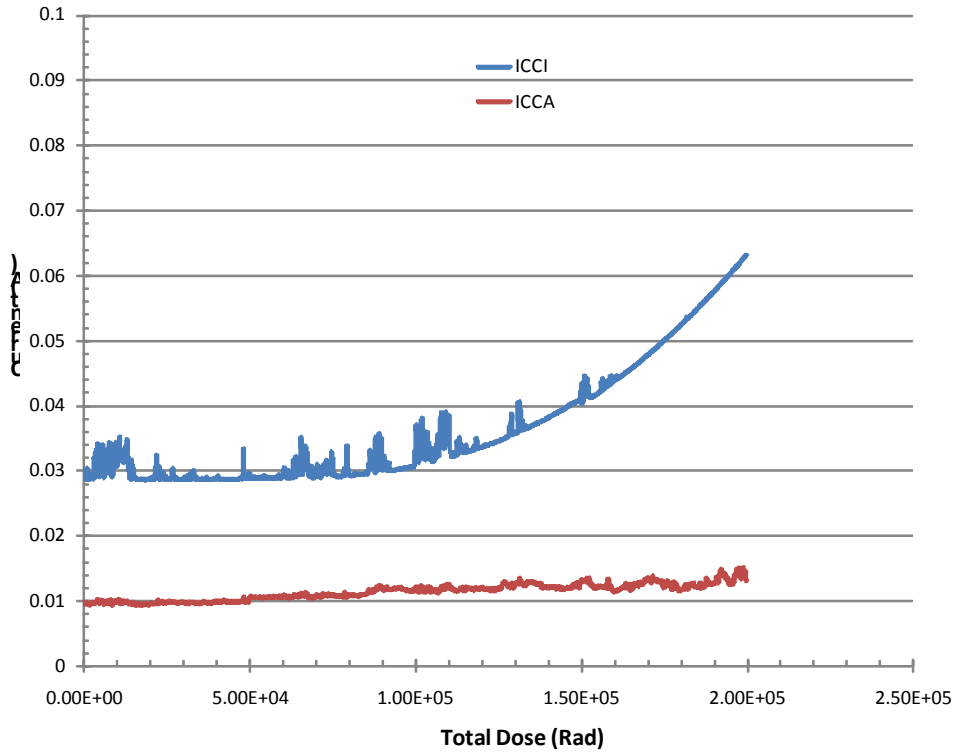

Figure 4 DUT 4142 in-flux  $I_{CCA}$  and  $I_{CCI}$ .

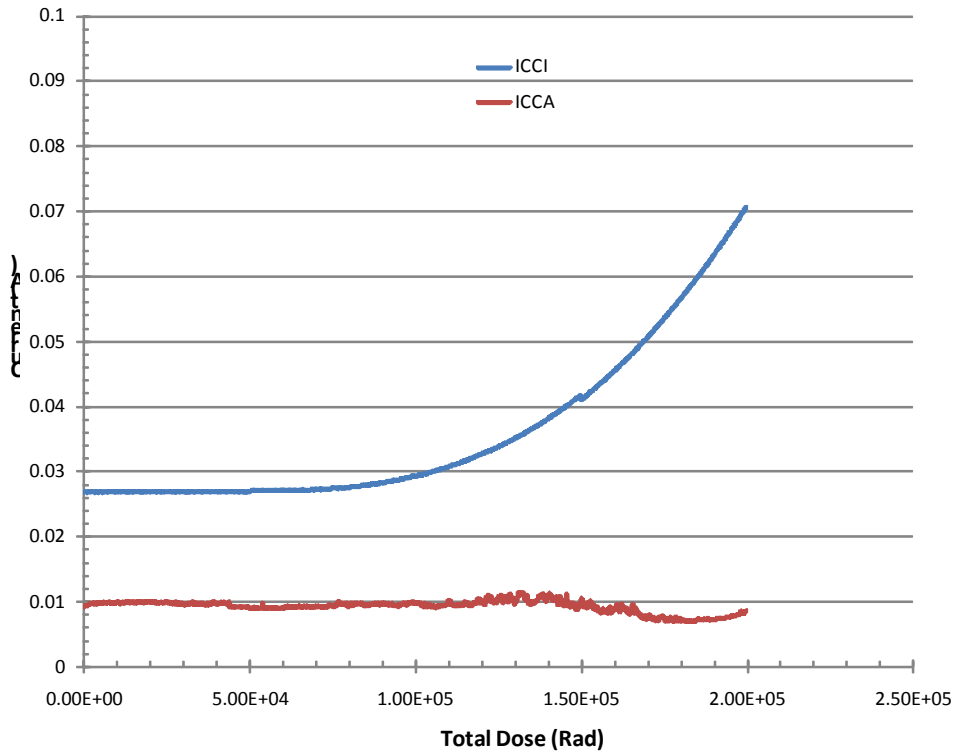

Figure 5 DUT 4146 in-flux  $I_{CCA}$  and  $I_{CCI}$ .

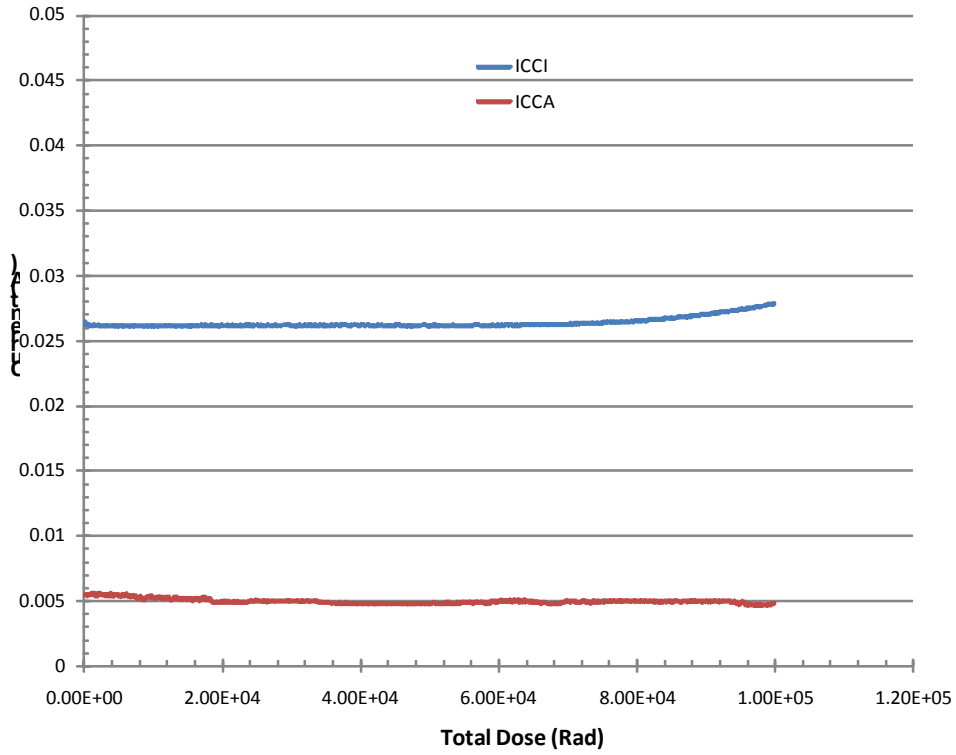

Figure 6 DUT 4148 in-flux  $I_{CCA}$  and  $I_{CCI}$ .

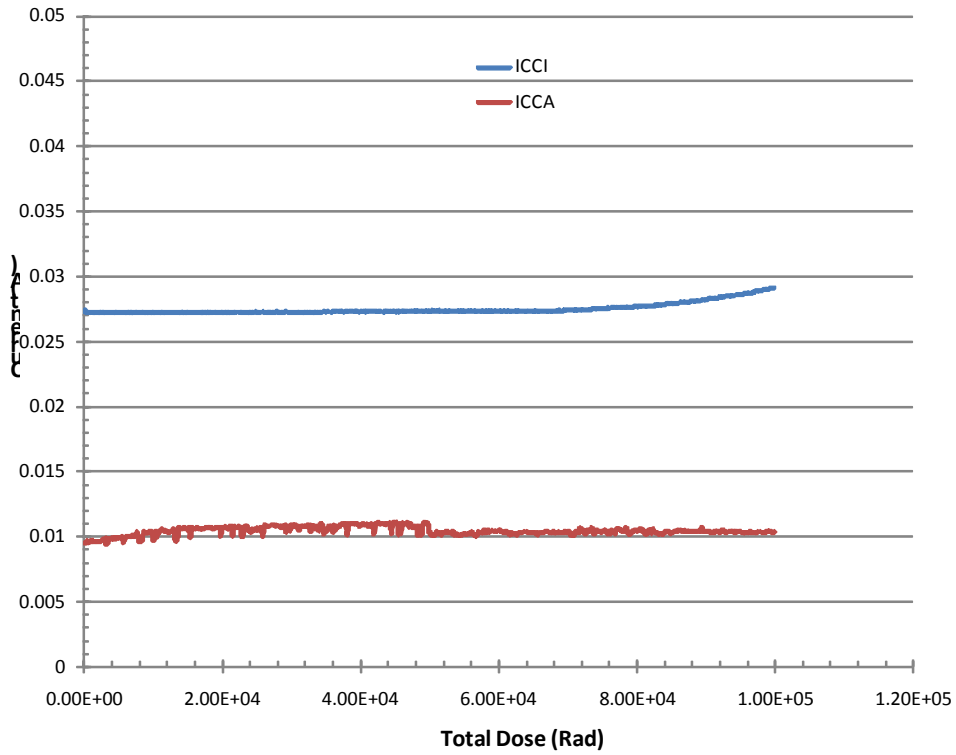

Figure 7 DUT 4149 in-flux  $I_{CCA}$  and  $I_{CCI}$ .

### C. Single-Ended Input Logic Threshold ( $V_{IL}/V_{IH}$ )

Table 4 lists the pre-irradiation and post-annealing single-ended input logic threshold. All data are within the spec limits. The post-annealing shift in every case is less than 10%.

Table 4a Pre-Irradiation and Post-Annealing Input Thresholds

DUT	4139(300krad)				4140 (300krad)			
	Pre-Irrad	Post-Ann	Pre-Irrad	Post-Ann	Pre-Irrad	Post-Ann	Pre-Irrad	Post-Ann
	$V_{IL}$ (mV)		$V_{IH}$ (V)		$V_{IL}$ (V)		$V_{IH}$ (V)	
DA	1515	1505	1490	1485	1520	1505	1490	1490
EN8	1520	1485	1480	1495	1520	1490	1500	1495
IO_I6	1520	1510	1495	1485	1520	1505	1495	1480
IO_I5	1530	1520	1480	1495	1515	1515	1480	1485
IO_I4	1505	1500	1505	1490	1500	1505	1505	1500
IO_I3	1475	1465	1520	1475	1475	1465	1515	1505
IO_I2	1515	1510	1495	1490	1510	1515	1530	1480
IO_I1	1520	1500	1500	1485	1510	1505	1530	1485

Table 4b Pre-Irradiation and Post-Annealing Input Thresholds

DUT	4142 (200krad)				4146 (200krad)			
	Pre-Irrad	Post-Ann	Pre-Irrad	Post-Ann	Pre-Irrad	Post-Ann	Pre-Irrad	Post-Ann
	$V_{IL}$ (mV)		$V_{IH}$ (V)		$V_{IL}$ (V)		$V_{IH}$ (V)	
DA	1520	1520	1490	1485	1520	1505	1505	1500
EN8	1525	1520	1480	1495	1535	1495	1500	1495
IO_I6	1520	1520	1495	1485	1520	1520	1495	1480
IO_I5	1530	1525	1480	1495	1530	1525	1480	1495
IO_I4	1505	1505	1490	1500	1505	1500	1525	1490
IO_I3	1510	1475	1520	1475	1525	1475	1520	1475
IO_I2	1525	1515	1505	1495	1525	1515	1505	1495
IO_I1	1515	1515	1500	1475	1530	1520	1500	1475

Table 4c Pre-Irradiation and Post-Annealing Input Thresholds

DUT	4148 (100krad)				4149 (100krad)			
	Pre-Irrad	Post-Ann	Pre-Irrad	Post-Ann	Pre-Irrad	Post-Ann	Pre-Irrad	Post-Ann
	$V_{IL}$ (mV)		$V_{IH}$ (V)		$V_{IL}$ (V)		$V_{IH}$ (V)	
DA	1520	1520	1495	1485	1520	1520	1490	1490
EN8	1505	1525	1485	1480	1525	1510	1480	1495
IO_I6	1520	1515	1495	1485	1520	1520	1495	1485
IO_I5	1510	1510	1510	1480	1525	1500	1480	1495
IO_I4	1515	1505	1505	1500	1505	1505	1505	1500
IO_I3	1525	1475	1540	1535	1475	1475	1520	1475
IO_I2	1525	1515	1505	1495	1525	1515	1525	1525
IO_I1	1515	1505	1515	1505	1505	1515	1490	1480

### D. Differential Input (LVPECL) Threshold Voltage ( $V_{IL}/V_{IH}$ )

Table 5 lists the LVPECL differential input threshold voltage changes due to irradiations. All pins show negligible changes, and all the data are within the specification.



Table 5a Pre-Irradiation and Post-Annealing Differential Input Thresholds

DUT	4139(300krad)				4140 (300krad)			
	Pre-Irrad	Post-Ann	Pre-Irrad	Post-Ann	Pre-Irrad	Post-Ann	Pre-Irrad	Post-Ann
	$V_{IL}$ (mV)		$V_{IH}$ (mV)		$V_{IL}$ (mV)		$V_{IH}$ (mV)	
DIO_I7P	1795	1795	1780	1780	1785	1785	1785	1780
DIO_I6P	1795	1780	1790	1795	1780	1780	1795	1795
DIO_I5P	1790	1785	1775	1775	1785	1800	1775	1775
DIO_I4P	1810	1785	1780	1785	1780	1810	1780	1780
DIO_I3P	1790	1790	1780	1785	1785	1790	1780	1780
DIO_I2P	1790	1795	1780	1780	1785	1785	1770	1770
DIO_I1P	1785	1785	1770	1770	1780	1780	1770	1770

Table 5b Pre-Irradiation and Post-Annealing Differential Input Thresholds

DUT	4142 (200krad)				4146 (200krad)			
	Pre-Irrad	Post-Ann	Pre-Irrad	Post-Ann	Pre-Irrad	Post-Ann	Pre-Irrad	Post-Ann
	$V_{IL}$ (mV)		$V_{IH}$ (mV)		$V_{IL}$ (mV)		$V_{IH}$ (mV)	
DIO_I7P	1800	1800	1795	1795	1785	1785	1785	1780
DIO_I6P	1780	1810	1795	1795	1775	1805	1795	1795
DIO_I5P	1790	1800	1775	1785	1800	1795	1775	1770
DIO_I4P	1780	1785	1780	1780	1785	1795	1785	1780
DIO_I3P	1785	1785	1770	1770	1785	1790	1775	1780
DIO_I2P	1790	1790	1775	1775	1790	1795	1780	1780
DIO_I1P	1785	1790	1780	1780	1780	1780	1765	1770

Table 5c Pre-Irradiation and Post-Annealing Differential Input Thresholds

DUT	4148 (100krad)				4149 (100krad)			
	Pre-Irrad	Post-Ann	Pre-Irrad	Post-Ann	Pre-Irrad	Post-Ann	Pre-Irrad	Post-Ann
	$V_{IL}$ (mV)		$V_{IH}$ (mV)		$V_{IL}$ (mV)		$V_{IH}$ (mV)	
DIO_I7P	1795	1795	1785	1780	1800	1795	1795	1790
DIO_I6P	1780	1805	1780	1780	1805	1805	1785	1785
DIO_I5P	1790	1785	1775	1775	1785	1790	1775	1775
DIO_I4P	1780	1775	1780	1780	1790	1785	1770	1775
DIO_I3P	1795	1790	1785	1785	1785	1785	1780	1775
DIO_I2P	1775	1790	1765	1765	1785	1795	1780	1775
DIO_I1P	1785	1785	1780	1780	1780	1790	1770	1770

### E. Output-Drive Voltage ( $V_{OL}/V_{OH}$ )

The pre-irradiation and post-annealing  $V_{OL}/V_{OH}$  are listed in Tables 6 and 7. The post-annealing data are within the spec limits.

Table 6 Pre-Irradiation and Post-Annealing  $V_{OL}$  (mV) at Various Sinking Current

DUT	Pin	1mA		12mA		20mA		50mA		100mA	
		Pre-rad	Post-an	Pre-rad	Post-an	Pre-rad	Post-an	Pre-rad	Post-an	Pre-rad	Post-an
4139 (300krad)	QA0	6.01	6.01	81.07	78.06	136.11	130.10	344.28	329.26	721.58	689.55
	YQ0	7.00	7.00	92.97	89.97	154.95	149.96	393.88	378.89	821.75	787.76
4140 (300krad)	QA0	6.01	6.01	80.06	77.06	135.11	129.10	341.27	327.26	715.57	685.55
	YQ0	7.00	6.00	90.97	87.97	152.95	146.96	387.88	370.89	808.76	772.77
4142 (200krad)	QA0	6.01	6.01	82.07	80.06	138.11	133.11	350.28	338.27	734.59	708.57
	YQ0	7.00	7.00	88.97	85.97	149.96	144.96	380.89	367.89	795.76	767.77
4146 (200krad)	QA0	6.01	6.01	82.07	79.06	137.11	132.11	348.28	334.27	730.58	701.56
	YQ0	7.00	7.00	91.97	88.97	154.95	148.96	392.88	376.89	820.75	786.76
4148 (100krad)	QA0	6.01	6.01	82.07	81.07	138.11	134.11	351.28	341.27	739.59	718.57
	YQ0	7.00	7.00	92.97	90.97	155.95	152.95	396.88	386.88	829.75	808.76
4149 (100krad)	QA0	6.01	6.01	81.07	79.06	135.11	132.11	343.27	334.27	720.58	701.56
	YQ0	7.00	7.00	91.97	89.97	153.95	149.96	389.88	380.89	813.76	792.76

Table 7 Pre-Irradiation and Post-Annealing  $V_{OH}$  (mV) at Various Sourcing Current

DUT	Pin	1mA		8mA		20mA		50mA		100mA	
		Pre-rad	Post-an	Pre-rad	Post-an	Pre-rad	Post-an	Pre-rad	Post-an	Pre-rad	Post-an
4139 (300krad)	QA0	3285.53	3280.53	3220.52	3220.52	3110.50	3110.50	2825.45	2820.45	2265.36	2260.36
	YQ0	3283.56	3278.56	3213.59	3208.59	3093.64	3093.64	2783.78	2783.78	2189.04	2184.04
4140 (300krad)	QA0	3285.53	3280.53	3220.52	3215.51	3115.50	3110.50	2830.45	2825.45	2280.37	2270.36
	YQ0	3283.56	3278.56	3213.59	3213.59	3098.64	3093.64	2788.77	2783.78	2199.03	2199.03
4142 (200krad)	QA0	3285.53	3280.53	3220.52	3220.52	3110.50	3105.50	2820.45	2815.45	2255.36	2250.36
	YQ0	3283.56	3278.56	3213.59	3213.59	3098.64	3098.64	2793.77	2788.77	2204.03	2199.03
4146 (200krad)	QA0	3285.53	3280.53	3220.52	3220.52	3110.50	3110.50	2825.45	2820.45	2265.36	2260.36
	YQ0	3283.56	3278.56	3213.59	3213.59	3093.64	3093.64	2788.77	2783.78	2194.03	2189.04
4148 (100krad)	QA0	3285.53	3285.53	3220.52	3220.52	3110.50	3110.50	2820.45	2820.45	2245.36	2245.36
	YQ0	3283.56	3283.56	3213.59	3213.59	3093.64	3093.64	2773.78	2773.78	2159.05	2164.05
4149 (100krad)	QA0	3285.53	3285.53	3220.52	3220.52	3110.50	3115.50	2830.45	2830.45	2270.36	2275.36
	YQ0	3283.56	3283.56	3218.58	3213.59	3093.64	3098.64	2783.78	2788.77	2189.04	2194.03

### F. Propagation Delay

The propagation delay was measured in-situ, post-irradiation, and post-annealing. The irradiation was temporarily stopped at each total-dose increment of 50 krad for the measurement. Each measurement has a 2-minutes wait following the irradiation shut-down. The results are plotted in Figure 8, and also listed in Table 8. As shown in Figure 8, the propagation delay initially decreases with the total dose, dips to a minimum when the total dose is around 150 krad, and then increases above 200 krad. However, as listed in Table 8, the change is small throughout the irradiation. Referring to in-flux static current plots (Figure 2-7), the device might heat up as the dose increases. The rising temperature could be the root cause of the increasing trend above 200 krad.

The post-annealing data, on the other hand, show decreased delay in every case.

The radiation delta in every case is well within the 10% degradation criterion. User can take the worst case for the design-margin consideration.

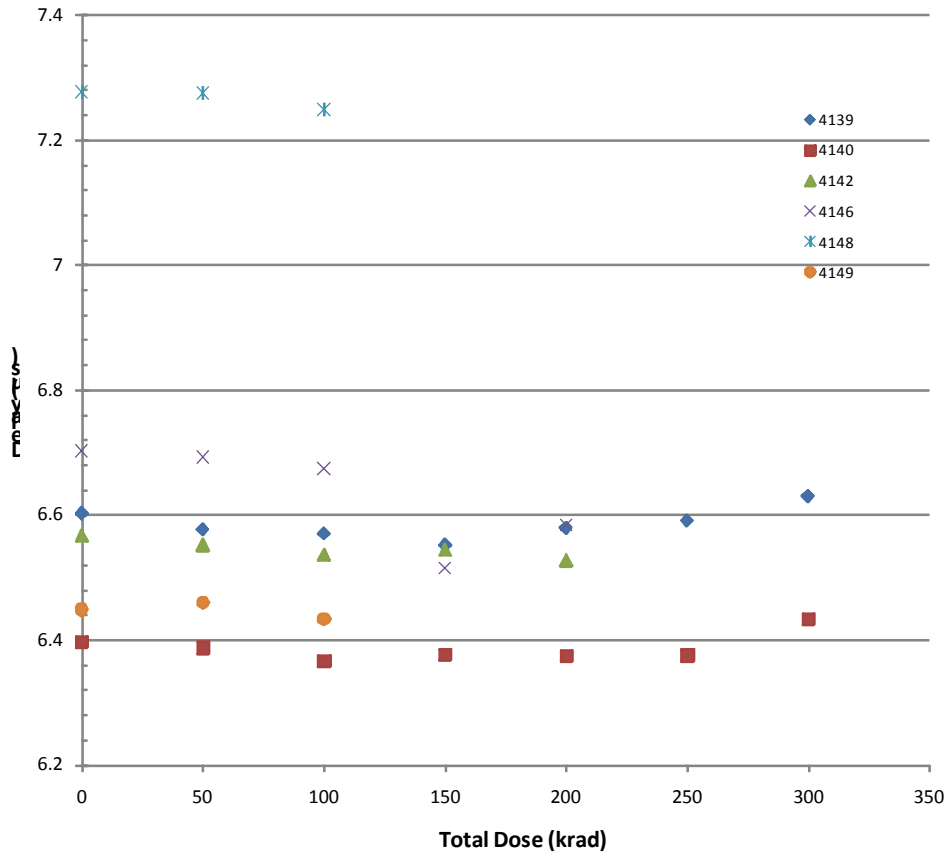

Figure 8 In-situ propagation delay versus total dose. The measurement was performed when irradiation was temporarily stopped.

Table 8 Radiation-Induced Propagation-Delay Degradations

DUT		Pre-rad	50 krad	100 krad	150 krad	200 krad	250 krad	300 krad	Post-ann
4139	Delay ( $\mu$ s)	6.603	6.5775	6.571	6.5525	6.58	6.5915	6.6305	6.505
	Radiation $\Delta$	—	-0.39%	-0.48%	-0.76%	-0.35%	-0.17%	0.42%	-1.48%
4140	Delay ( $\mu$ s)	6.3975	6.388	6.367	6.3765	6.374	6.3755	6.4335	6.3
	Radiation $\Delta$	—	-0.15%	-0.48%	-0.33%	-0.37%	-0.34%	0.56%	-1.52%
4142	Delay ( $\mu$ s)	6.568	6.5525	6.537	6.5445	6.528	—	—	6.466
	Radiation $\Delta$	—	-0.24%	-0.47%	-0.36%	-0.61%	—	—	-1.55%
4146	Delay ( $\mu$ s)	6.7025	6.692	6.674	6.514	6.583	—	—	6.5925
	Radiation $\Delta$	—	-0.16%	-0.43%	-2.81%	-1.78%	—	—	-1.64%
4148	Delay ( $\mu$ s)	7.277	7.275	7.2485	—	—	—	—	7.185
	Radiation $\Delta$	—	-0.03%	-0.39%	—	—	—	—	-1.26%
4149	Delay ( $\mu$ s)	6.449	6.46	6.4335	—	—	—	—	6.375
	Radiation $\Delta$	—	0.17%	-0.24%	—	—	—	—	-1.15%

### G. Transition Characteristics

Figures 9 to 16 show the pre-irradiation and post-annealing transition edges. In each case, the radiation-induced transition-time degradation is insignificant. The data for DUT 4148 and 4149 are missing because of an operator error.

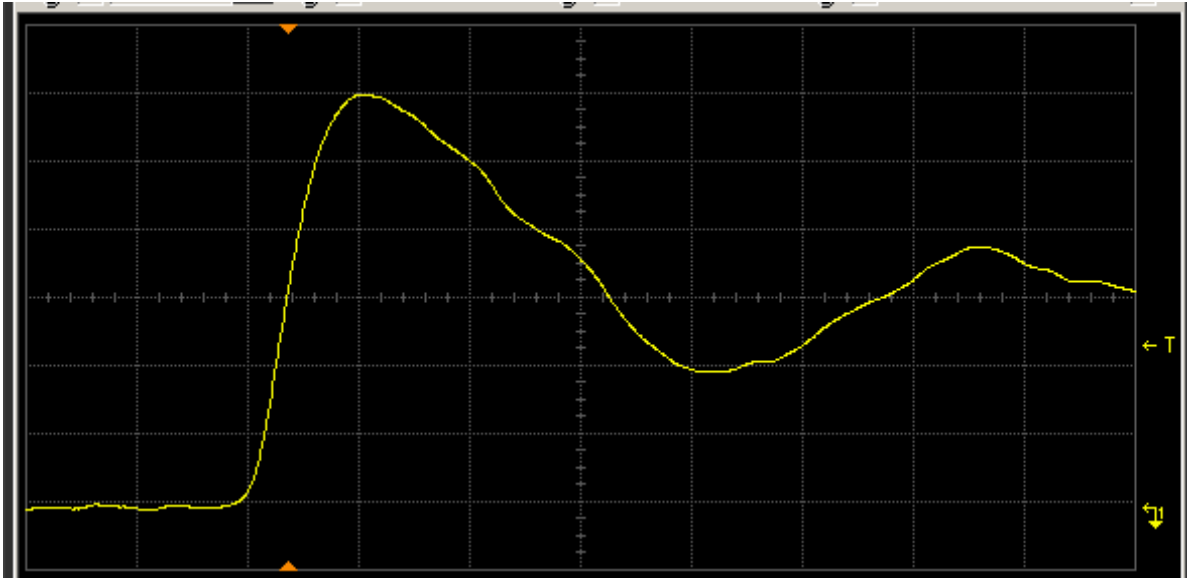

Figure 9(a) DUT 4139 pre-irradiation rising edge. The ordinate is 1 V/div, and abscissa 2 ns/div.

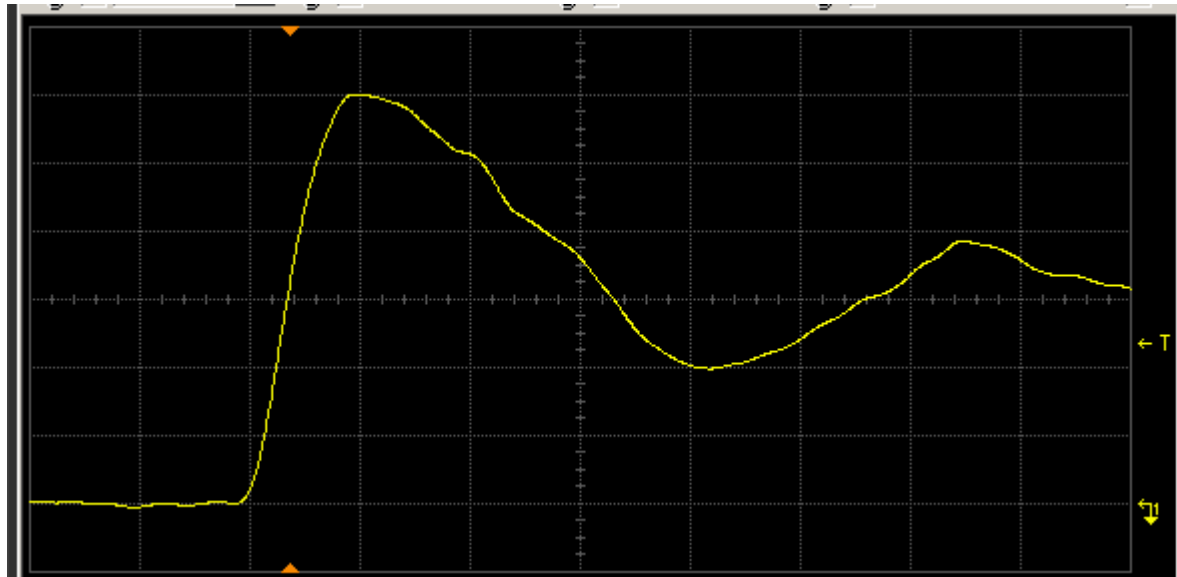

Figure 9(b) DUT 4139 post-annealing rising edge. The ordinate is 1 V/div, and abscissa 2 ns/div.

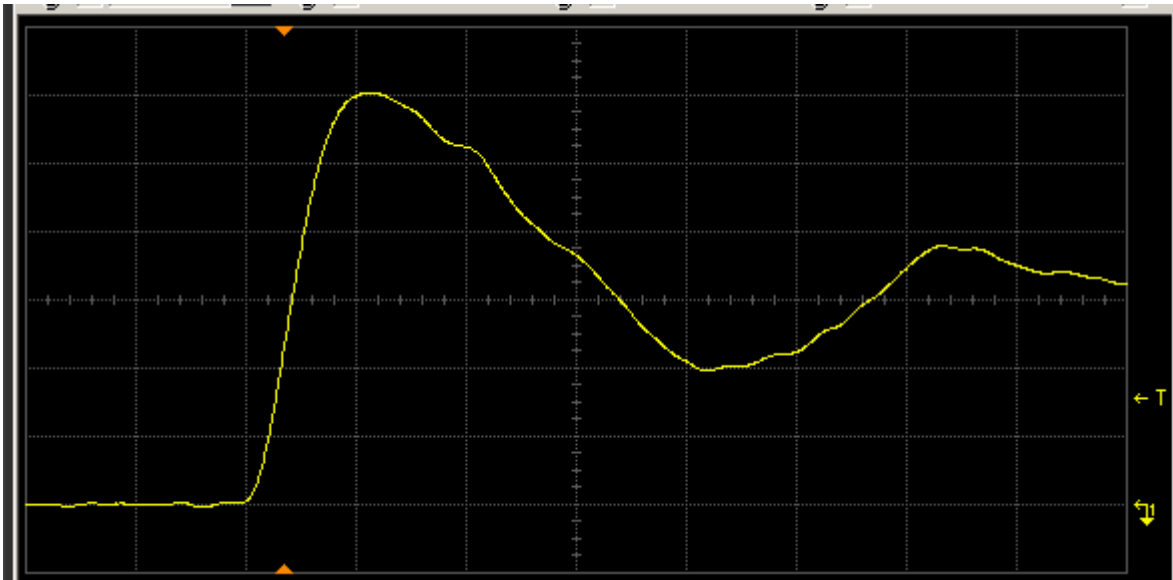

Figure 10(a) DUT 4140 pre-irradiation rising edge. The ordinate is 1 V/div, and abscissa 2 ns/div.

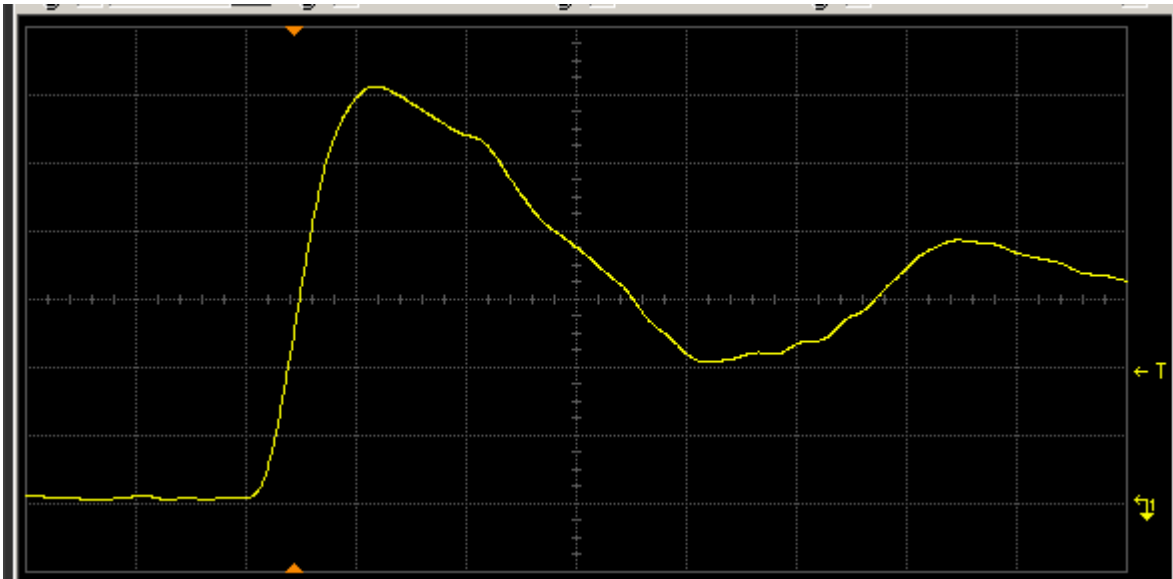

Figure 10(b) DUT 4140 post-annealing rising edge. The ordinate is 1 V/div, and abscissa 2 ns/div.

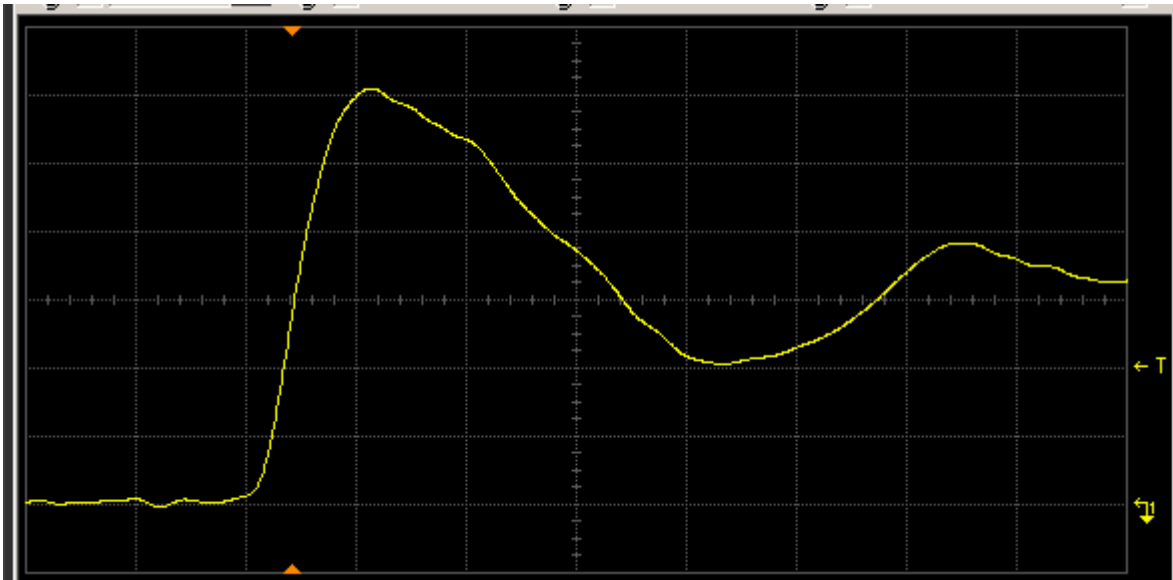

Figure 11(a) DUT 4142 pre-radiation rising edge. The ordinate is 1 V/div, and abscissa 2 ns/div.

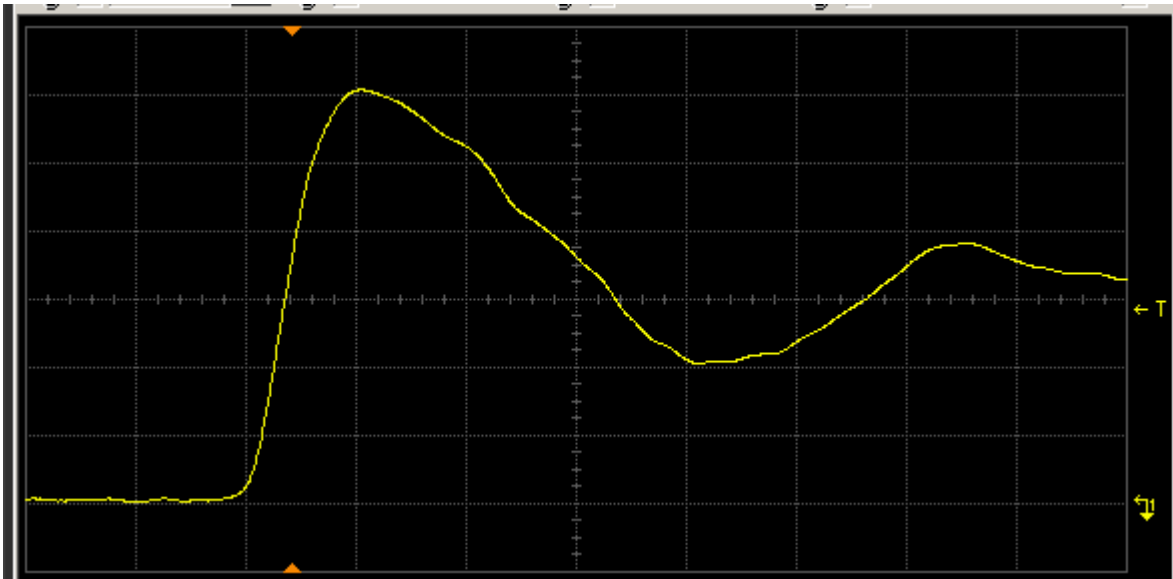

Figure 11(b) DUT 4142 post-annealing rising edge. The ordinate is 1 V/div, and abscissa 2 ns/div.

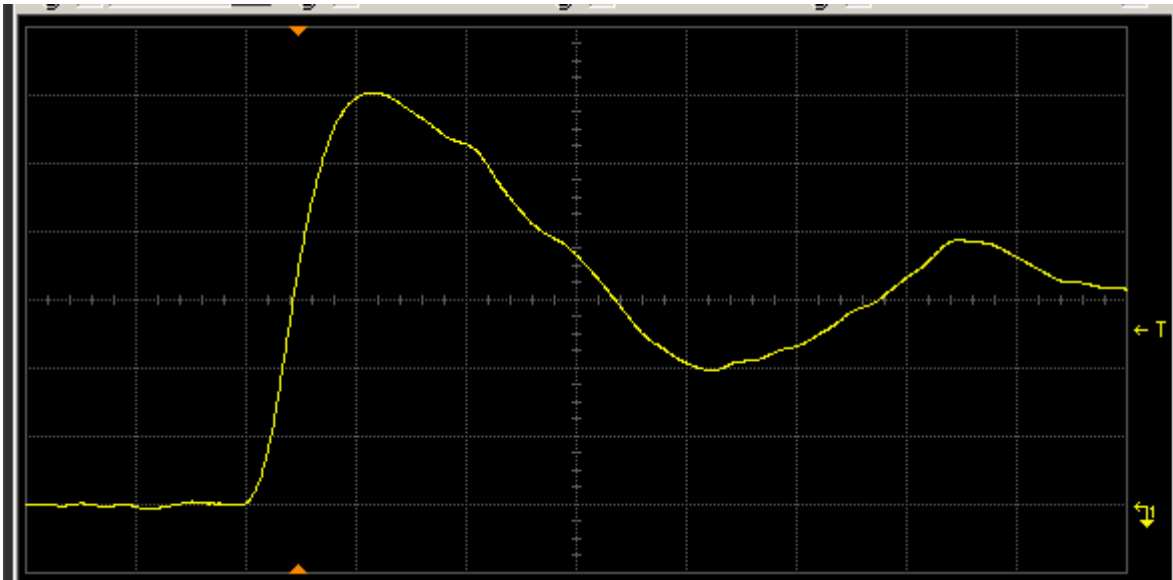

Figure 12(a) DUT 4146 pre-irradiation rising edge. The ordinate is 1 V/div, and abscissa 2 ns/div.

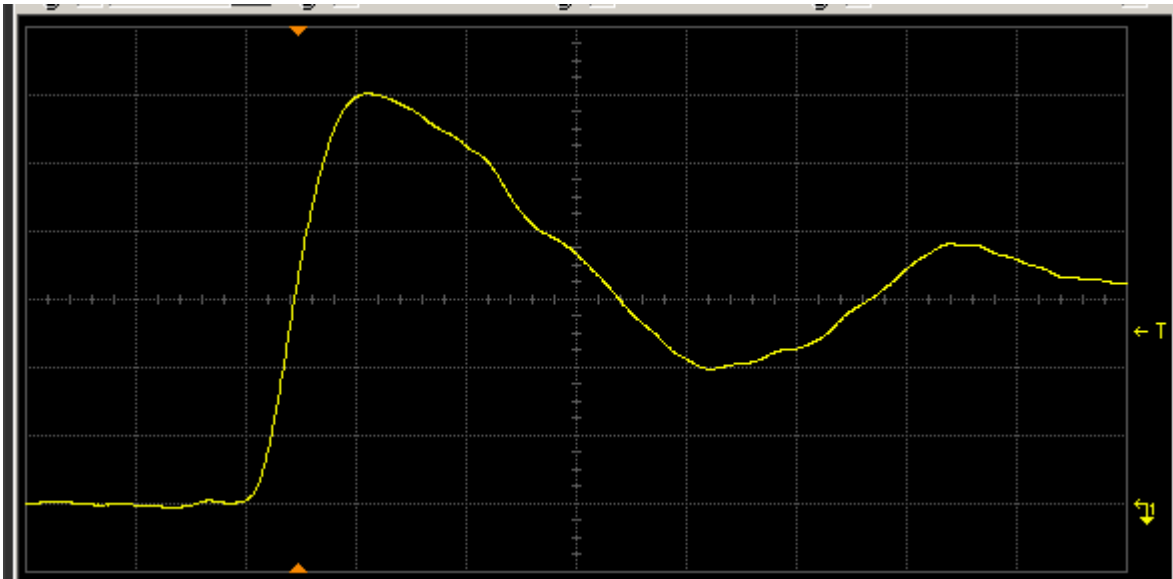

Figure 12(b) DUT 4146 post-annealing rising edge. The ordinate is 1 V/div, and abscissa 2 ns/div.



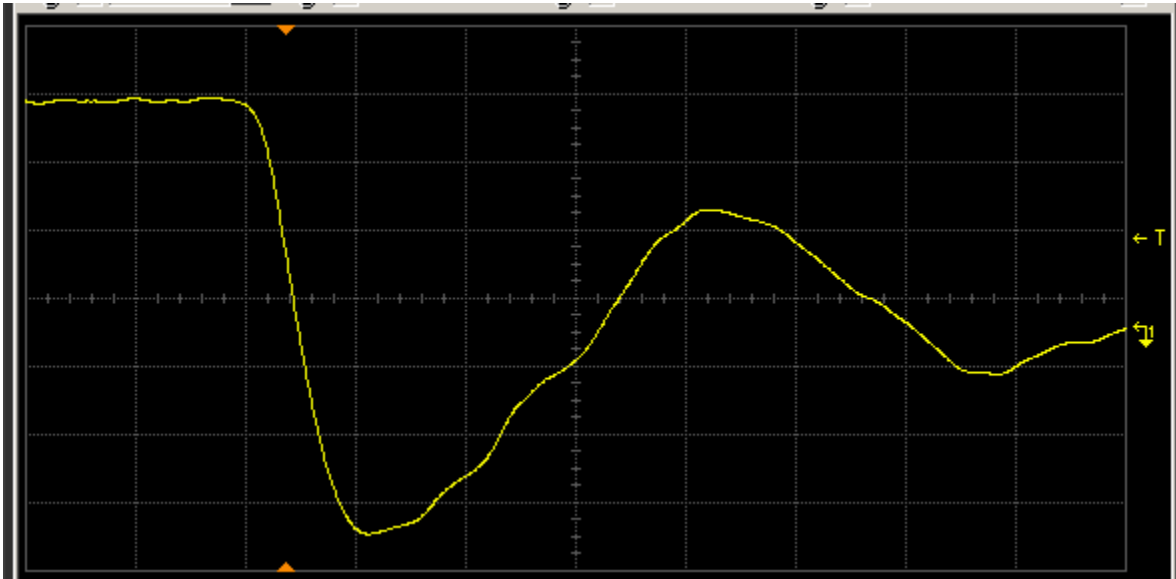

Figure 13(a) DUT 4139 pre-irradiation falling edge. The ordinate is 1 V/div, and abscissa 2 ns/div.

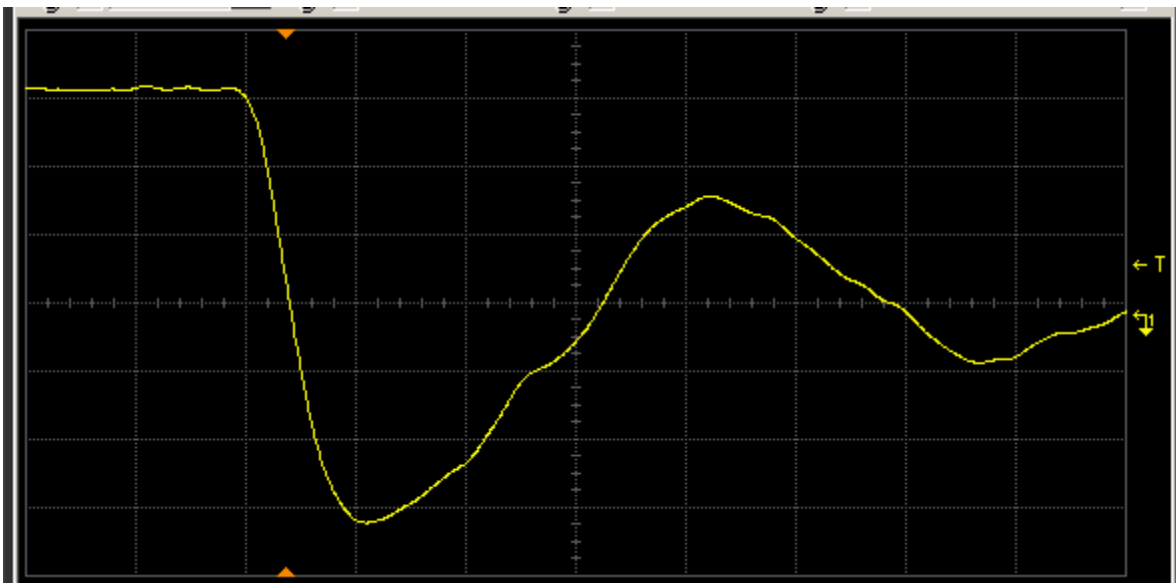

Figure 13(b) DUT 4139 post-annealing falling edge. The ordinate is 1 V/div, and abscissa 2 ns/div.

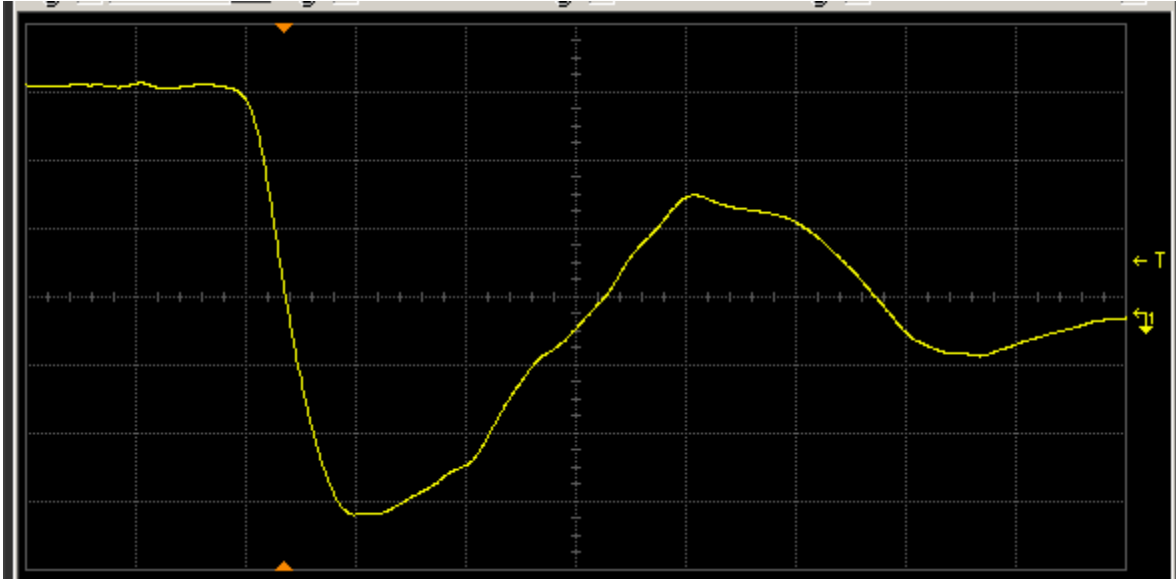

Figure 14(a) DUT 4140 pre-irradiation falling edge. The ordinate is 1 V/div, and abscissa 2 ns/div.

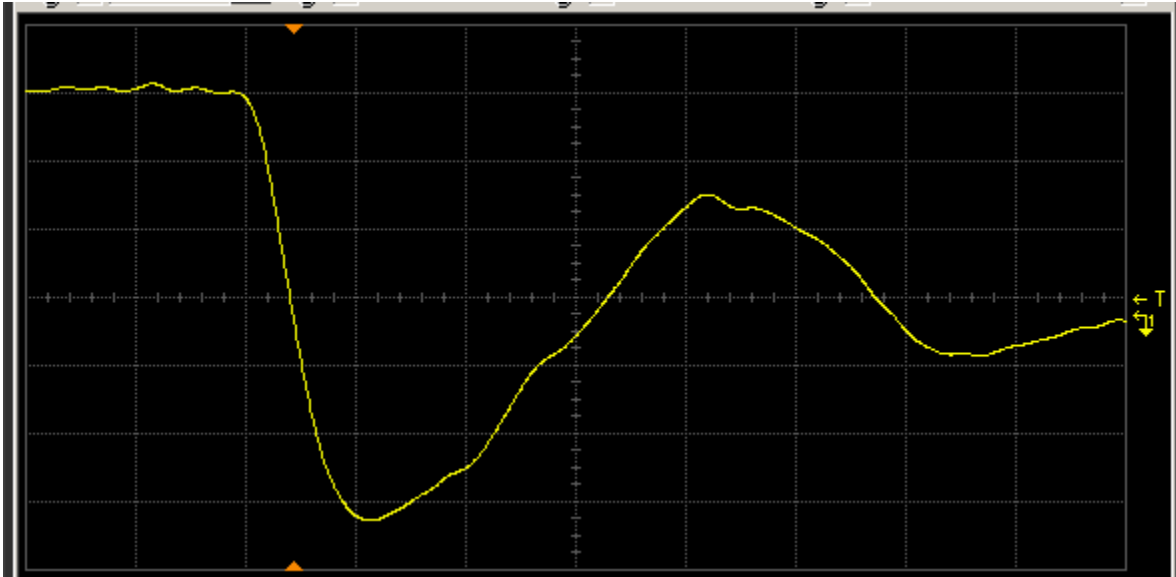

Figure 14(b) DUT 4140 post-annealing falling edge. The ordinate is 1 V/div, and abscissa 2 ns/div.

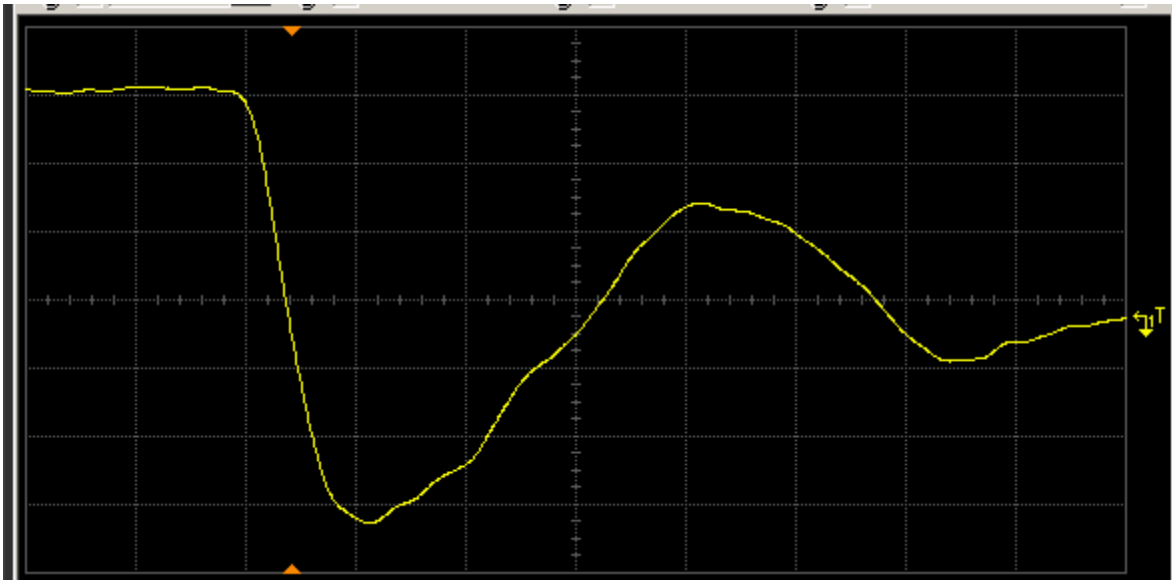

Figure 15(a) DUT 4142 pre-radiation falling edge. The ordinate is 1 V/div, and abscissa 2 ns/div.

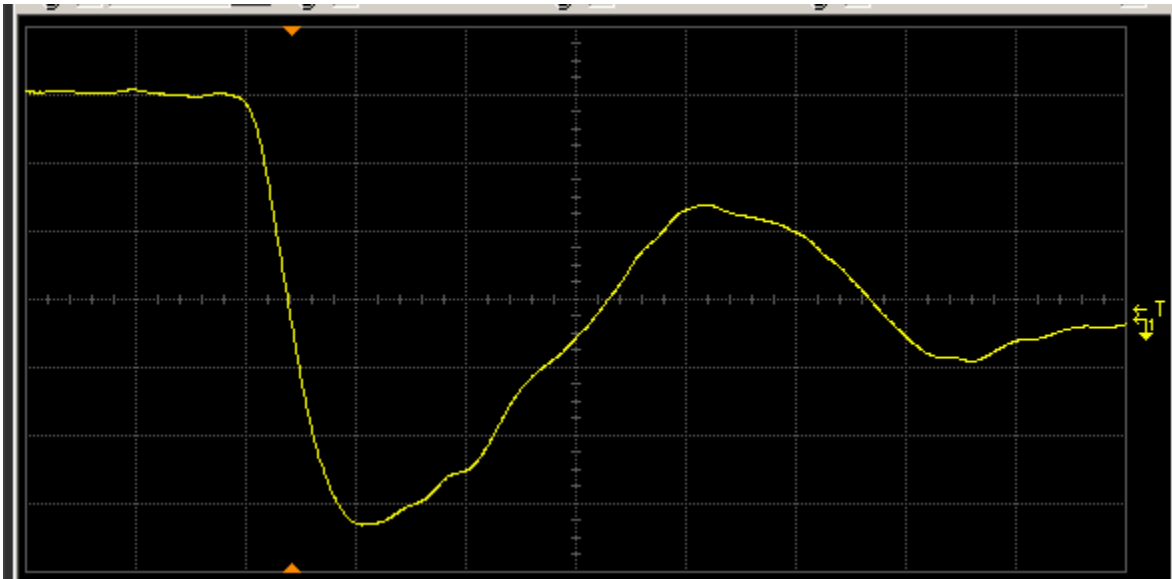

Figure 15(b) DUT 4142 post-annealing falling edge. The ordinate is 1 V/div, and abscissa 2 ns/div.

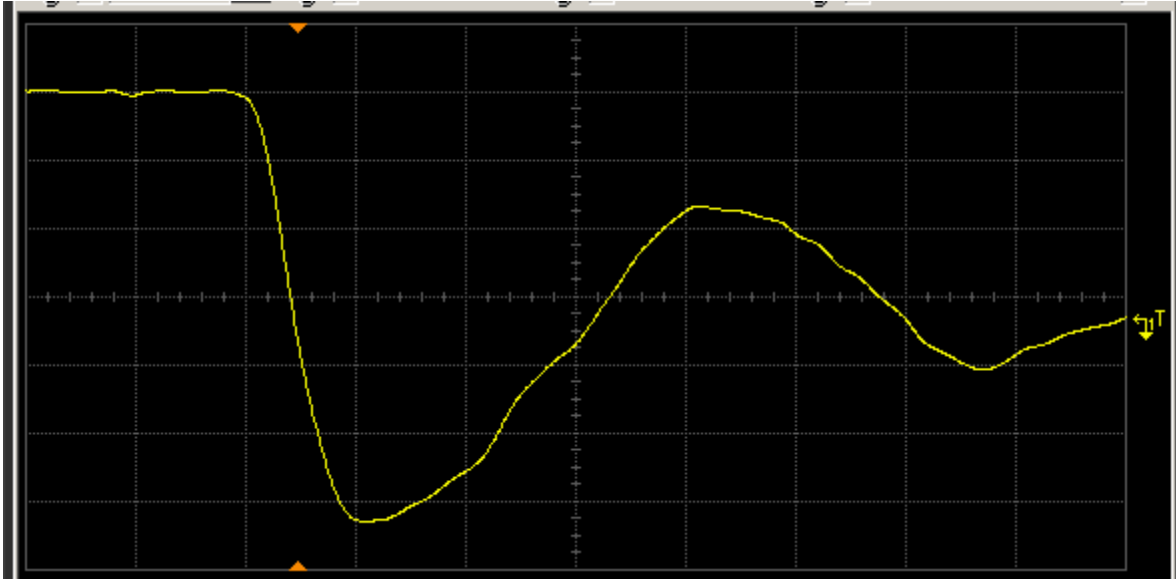

Figure 16(a) DUT 4146 pre-irradiation falling edge. The ordinate is 1 V/div, and abscissa 2 ns/div.

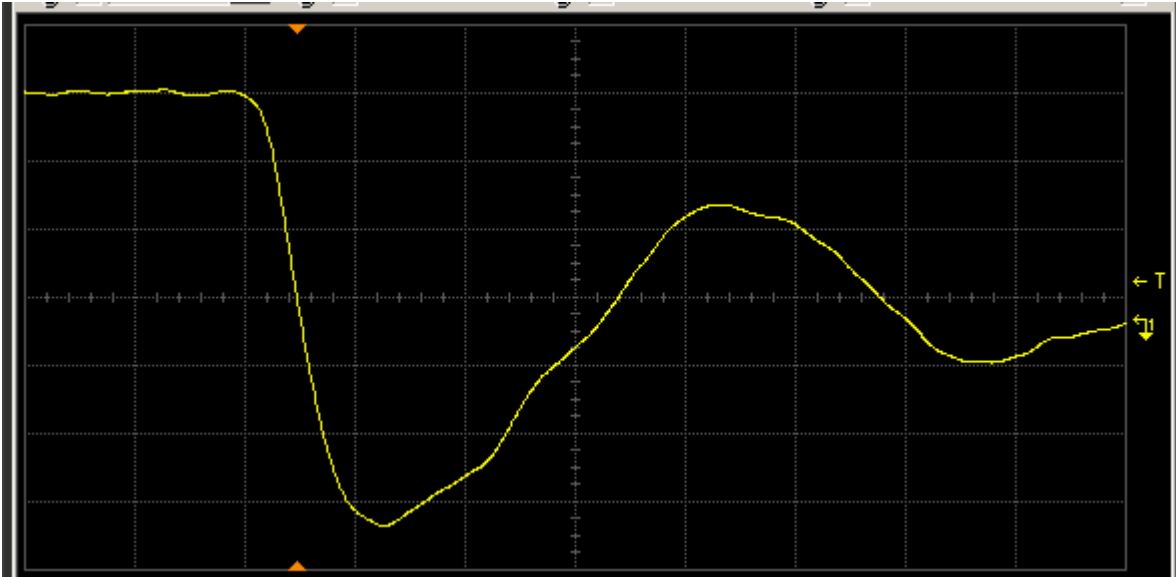

Figure 16(b) DUT 4146 post-annealing falling edge. The ordinate is 1 V/div, and abscissa 2 ns/div.



Figure A1 IO bias during irradiation

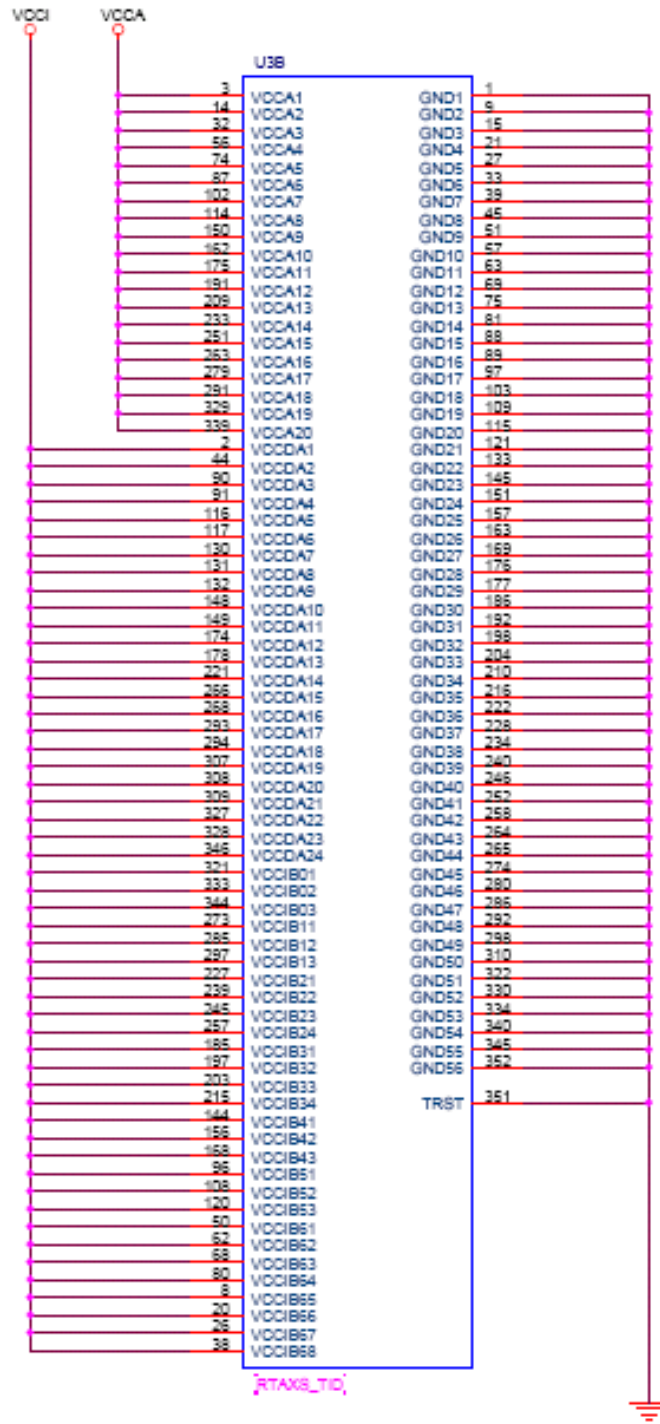
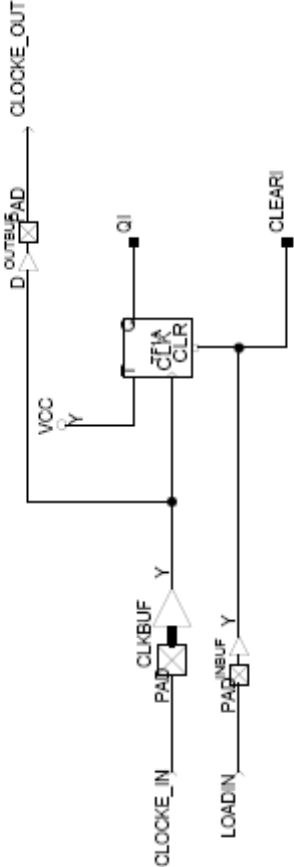
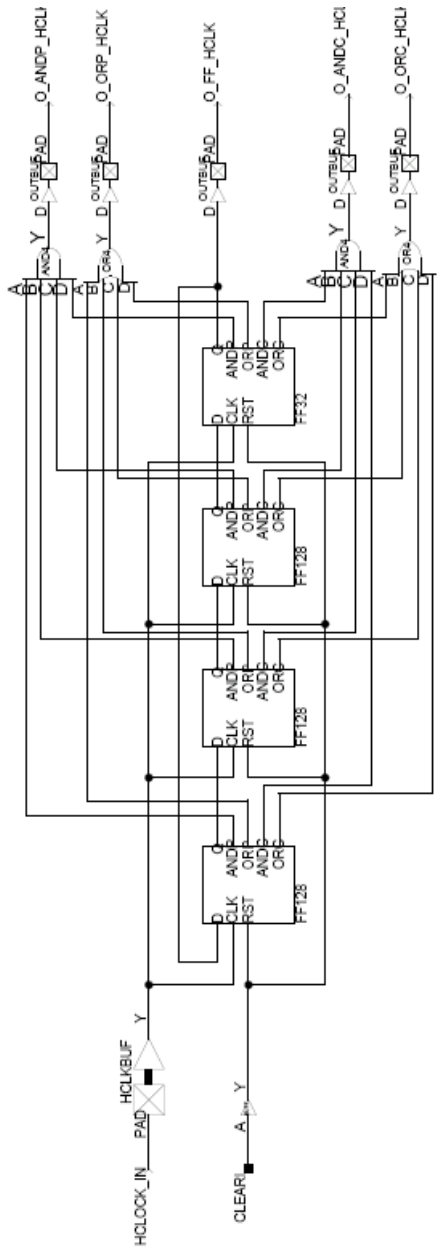

Figure A2 Power supply, ground and special pins bias during irradiation

APPENDIX B DUT DESIGN SCHEMATICS AND VERILOG FILES







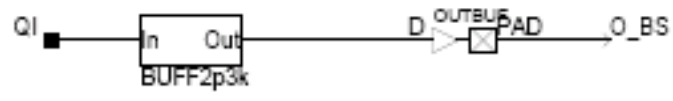

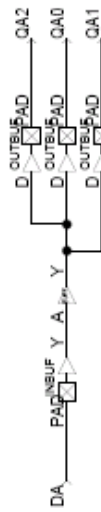
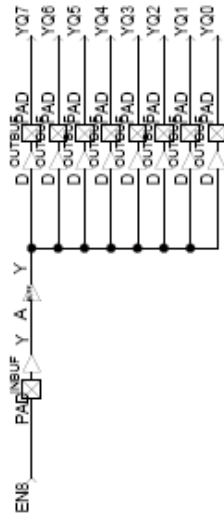

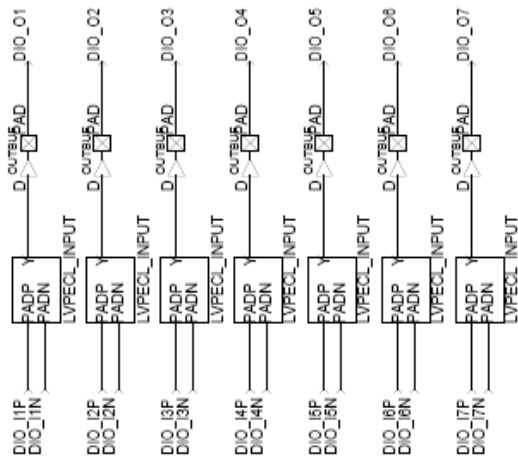
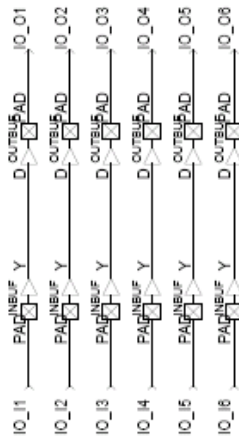

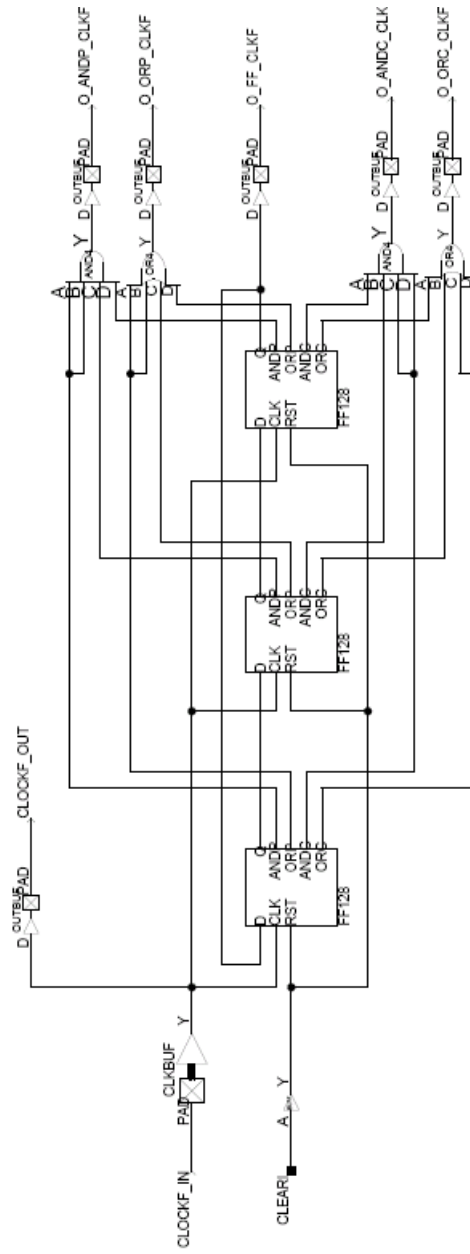

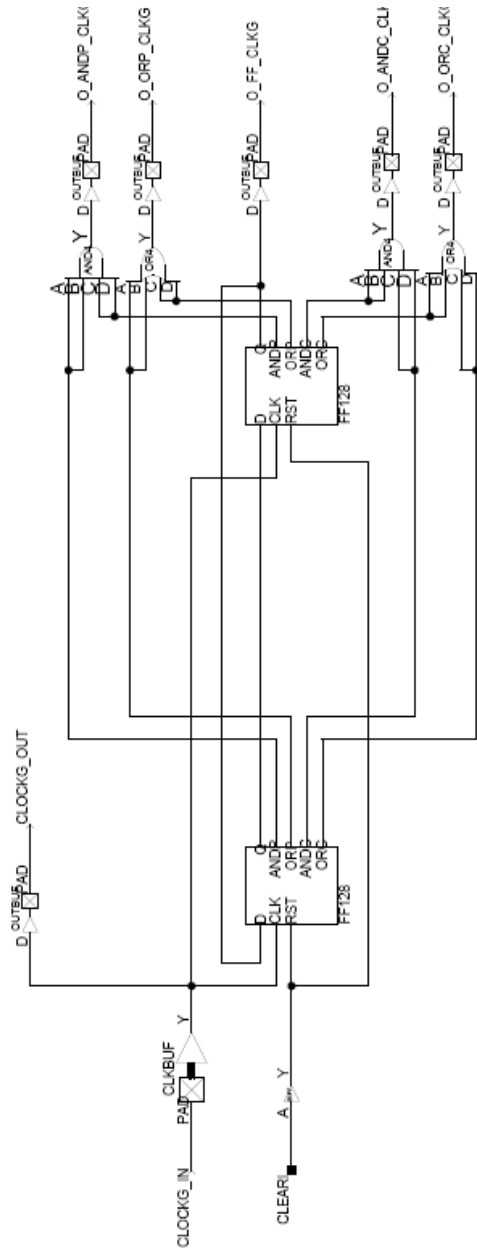

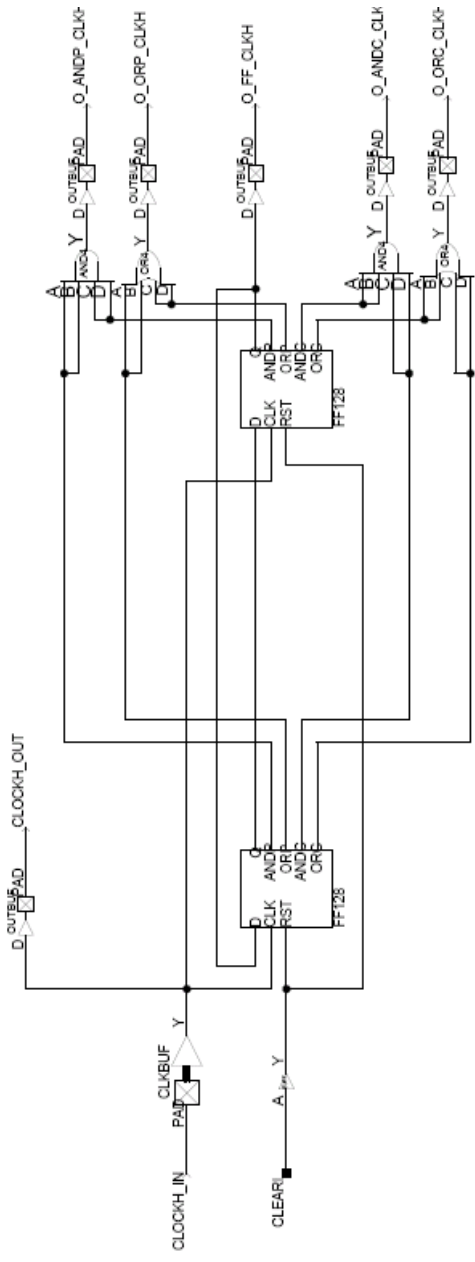

```

// BUFF2p3k.v
`timescale 1 ns/100 ps

module BUFF2p3k (In, Out);

input In;

output Out;

wire x1/*synthesis syn_keep=1 alspreserve=1*/;
wire x2/*synthesis syn_keep=1 alspreserve=1*/;
wire x3/*synthesis syn_keep=1 alspreserve=1*/;
wire x4/*synthesis syn_keep=1 alspreserve=1*/;
wire x5/*synthesis syn_keep=1 alspreserve=1*/;
wire x6/*synthesis syn_keep=1 alspreserve=1*/;
wire x7/*synthesis syn_keep=1 alspreserve=1*/;

BUFF1k buff1k_1 (.In(In), .Out(x1));
BUFF1k buff1k_2 (.In(x1), .Out(x2));
BUFF50 buff3 (.In(x2), .Out(x3));
BUFF50 buff4 (.In(x3), .Out(x4));
BUFF50 buff5 (.In(x4), .Out(x5));
BUFF50 buff6 (.In(x5), .Out(x6));
BUFF50 buff7 (.In(x6), .Out(x7));
BUFF50 buff8 (.In(x7), .Out(Out));

endmodule

// BUFF1k
`timescale 1 ns/100 ps

module BUFF1k (In, Out);

input In;

output Out;

wire x1/*synthesis syn_keep=1 alspreserve=1*/;
wire x2/*synthesis syn_keep=1 alspreserve=1*/;
wire x3/*synthesis syn_keep=1 alspreserve=1*/;
wire x4/*synthesis syn_keep=1 alspreserve=1*/;
wire x5/*synthesis syn_keep=1 alspreserve=1*/;
wire x6/*synthesis syn_keep=1 alspreserve=1*/;
wire x7/*synthesis syn_keep=1 alspreserve=1*/;
wire x8/*synthesis syn_keep=1 alspreserve=1*/;
wire x9/*synthesis syn_keep=1 alspreserve=1*/;
wire x10/*synthesis syn_keep=1 alspreserve=1*/;
wire x11/*synthesis syn_keep=1 alspreserve=1*/;
wire x12/*synthesis syn_keep=1 alspreserve=1*/;
wire x13/*synthesis syn_keep=1 alspreserve=1*/;
wire x14/*synthesis syn_keep=1 alspreserve=1*/;
wire x15/*synthesis syn_keep=1 alspreserve=1*/;
wire x16/*synthesis syn_keep=1 alspreserve=1*/;
wire x17/*synthesis syn_keep=1 alspreserve=1*/;
wire x18/*synthesis syn_keep=1 alspreserve=1*/;
wire x19/*synthesis syn_keep=1 alspreserve=1*/;

```

```

BUFF50 buff1 (.In(In), .Out(x1));
BUFF50 buff2 (.In(x1), .Out(x2));
BUFF50 buff3 (.In(x2), .Out(x3));
BUFF50 buff4 (.In(x3), .Out(x4));
BUFF50 buff5 (.In(x4), .Out(x5));
BUFF50 buff6 (.In(x5), .Out(x6));
BUFF50 buff7 (.In(x6), .Out(x7));
BUFF50 buff8 (.In(x7), .Out(x8));
BUFF50 buff9 (.In(x8), .Out(x9));
BUFF50 buff10 (.In(x9), .Out(x10));

```

```

BUFF50 buff11 (.In(x10), .Out(x11));
BUFF50 buff12 (.In(x11), .Out(x12));
BUFF50 buff13 (.In(x12), .Out(x13));
BUFF50 buff14 (.In(x13), .Out(x14));
BUFF50 buff15 (.In(x14), .Out(x15));
BUFF50 buff16 (.In(x15), .Out(x16));
BUFF50 buff17 (.In(x16), .Out(x17));
BUFF50 buff18 (.In(x17), .Out(x18));
BUFF50 buff19 (.In(x18), .Out(x19));
BUFF50 buff20 (.In(x19), .Out(Out));

```

```
endmodule
```

```
// BUFF50
```

```
`timescale 1 ns/100 ps
```

```
module BUFF50 (In, Out);
```

```
input In;
```

```
output Out;
```

```

wire x1 /*synthesis syn_keep=1 alspreserve=1*/;
wire x2 /*synthesis syn_keep=1 alspreserve=1*/;
wire x3 /*synthesis syn_keep=1 alspreserve=1*/;
wire x4 /*synthesis syn_keep=1 alspreserve=1*/;
wire x5 /*synthesis syn_keep=1 alspreserve=1*/;
wire x6/*synthesis syn_keep=1 alspreserve=1*/;
wire x7/*synthesis syn_keep=1 alspreserve=1*/;
wire x8/*synthesis syn_keep=1 alspreserve=1*/;
wire x9/*synthesis syn_keep=1 alspreserve=1*/;
wire x10/*synthesis syn_keep=1 alspreserve=1*/;
wire x11/*synthesis syn_keep=1 alspreserve=1*/;
wire x12/*synthesis syn_keep=1 alspreserve=1*/;
wire x13/*synthesis syn_keep=1 alspreserve=1*/;
wire x14/*synthesis syn_keep=1 alspreserve=1*/;
wire x15/*synthesis syn_keep=1 alspreserve=1*/;
wire x16/*synthesis syn_keep=1 alspreserve=1*/;
wire x17/*synthesis syn_keep=1 alspreserve=1*/;
wire x18/*synthesis syn_keep=1 alspreserve=1*/;
wire x19/*synthesis syn_keep=1 alspreserve=1*/;
wire x20/*synthesis syn_keep=1 alspreserve=1*/;
wire x21/*synthesis syn_keep=1 alspreserve=1*/;
wire x22/*synthesis syn_keep=1 alspreserve=1*/;

```



```
wire x23/*synthesis syn_keep=1 alspreserve=1*/;
wire x24/*synthesis syn_keep=1 alspreserve=1*/;
wire x25/*synthesis syn_keep=1 alspreserve=1*/;
wire x26/*synthesis syn_keep=1 alspreserve=1*/;
wire x27/*synthesis syn_keep=1 alspreserve=1*/;
wire x28/*synthesis syn_keep=1 alspreserve=1*/;
wire x29/*synthesis syn_keep=1 alspreserve=1*/;
wire x30/*synthesis syn_keep=1 alspreserve=1*/;
wire x31/*synthesis syn_keep=1 alspreserve=1*/;
wire x32/*synthesis syn_keep=1 alspreserve=1*/;
wire x33/*synthesis syn_keep=1 alspreserve=1*/;
wire x34/*synthesis syn_keep=1 alspreserve=1*/;
wire x35/*synthesis syn_keep=1 alspreserve=1*/;
wire x36/*synthesis syn_keep=1 alspreserve=1*/;
wire x37/*synthesis syn_keep=1 alspreserve=1*/;
wire x38/*synthesis syn_keep=1 alspreserve=1*/;
wire x39/*synthesis syn_keep=1 alspreserve=1*/;
wire x40/*synthesis syn_keep=1 alspreserve=1*/;
wire x41/*synthesis syn_keep=1 alspreserve=1*/;
wire x42/*synthesis syn_keep=1 alspreserve=1*/;
wire x43/*synthesis syn_keep=1 alspreserve=1*/;
wire x44/*synthesis syn_keep=1 alspreserve=1*/;
wire x45/*synthesis syn_keep=1 alspreserve=1*/;
wire x46/*synthesis syn_keep=1 alspreserve=1*/;
wire x47/*synthesis syn_keep=1 alspreserve=1*/;
wire x48/*synthesis syn_keep=1 alspreserve=1*/;
wire x49/*synthesis syn_keep=1 alspreserve=1*/;
```

```
BUFF buff1 (.A(In), .Y(x1));
BUFF buff2 (.A(x1), .Y(x2));
BUFF buff3 (.A(x2), .Y(x3));
BUFF buff4 (.A(x3), .Y(x4));
BUFF buff5 (.A(x4), .Y(x5));
BUFF buff6 (.A(x5), .Y(x6));
BUFF buff7 (.A(x6), .Y(x7));
BUFF buff8 (.A(x7), .Y(x8));
BUFF buff9 (.A(x8), .Y(x9));
BUFF buff10 (.A(x9), .Y(x10));
```

```
BUFF buff11 (.A(x10), .Y(x11));
BUFF buff12 (.A(x11), .Y(x12));
BUFF buff13 (.A(x12), .Y(x13));
BUFF buff14 (.A(x13), .Y(x14));
BUFF buff15 (.A(x14), .Y(x15));
BUFF buff16 (.A(x15), .Y(x16));
BUFF buff17 (.A(x16), .Y(x17));
BUFF buff18 (.A(x17), .Y(x18));
BUFF buff19 (.A(x18), .Y(x19));
BUFF buff20 (.A(x19), .Y(x20));
```

```
BUFF buff21 (.A(x20), .Y(x21));
BUFF buff22 (.A(x21), .Y(x22));
BUFF buff23 (.A(x22), .Y(x23));
BUFF buff24 (.A(x23), .Y(x24));
BUFF buff25 (.A(x24), .Y(x25));
BUFF buff26 (.A(x25), .Y(x26));
```

```

BUFF buff27 (.A(x26), .Y(x27));
BUFF buff28 (.A(x27), .Y(x28));
BUFF buff29 (.A(x28), .Y(x29));
BUFF buff30 (.A(x29), .Y(x30));

```

```

BUFF buff31 (.A(x30), .Y(x31));
BUFF buff32 (.A(x31), .Y(x32));
BUFF buff33 (.A(x32), .Y(x33));
BUFF buff34 (.A(x33), .Y(x34));
BUFF buff35 (.A(x34), .Y(x35));
BUFF buff36 (.A(x35), .Y(x36));
BUFF buff37 (.A(x36), .Y(x37));
BUFF buff38 (.A(x37), .Y(x38));
BUFF buff39 (.A(x38), .Y(x39));
BUFF buff40 (.A(x39), .Y(x40));

```

```

BUFF buff41 (.A(x40), .Y(x41));
BUFF buff42 (.A(x41), .Y(x42));
BUFF buff43 (.A(x42), .Y(x43));
BUFF buff44 (.A(x43), .Y(x44));
BUFF buff45 (.A(x44), .Y(x45));
BUFF buff46 (.A(x45), .Y(x46));
BUFF buff47 (.A(x46), .Y(x47));
BUFF buff48 (.A(x47), .Y(x48));
BUFF buff49 (.A(x48), .Y(x49));
BUFF buff50 (.A(x49), .Y(Out));

```

```
endmodule
```

```
// FF128
```

```
`timescale 1 ns/100 ps
```

```
module FF128 (D, Q, CLK, RST, ANDP, ORP, ANDC, ORC);
```

```
input D, CLK, RST;
```

```
output Q, ANDP, ORP, ANDC, ORC;
```

```
wire x1, x2, x3, Q;
```

```
wire andp_a, andp_b, andp_c, andp_d, orp_a, orp_b, orp_c, orp_d;
```

```
wire andc_a, andc_b, andc_c, andc_d, orc_a, orc_b, orc_c, orc_d;
```

```
FF32 dff_a (.D(D), .Q(x1), .CLK(CLK), .RST(RST), .ANDP(andp_a), .ORP(orp_a),
.ANDC(andc_a), .ORC(orc_a));
```

```
FF32 dff_b (.D(x1), .Q(x2), .CLK(CLK), .RST(RST), .ANDP(andp_b), .ORP(orp_b),
.ANDC(andc_b), .ORC(orc_b));
```

```
FF32 dff_c (.D(x2), .Q(x3), .CLK(CLK), .RST(RST), .ANDP(andp_c), .ORP(orp_c),
.ANDC(andc_c), .ORC(orc_c));
```

```
FF32 dff_d (.D(x3), .Q(Q), .CLK(CLK), .RST(RST), .ANDP(andp_d), .ORP(orp_d),
.ANDC(andc_d), .ORC(orc_d));
```

```
AND4 and4p (.A(andp_a), .B(andp_b), .C(andp_c), .D(andp_d), .Y(ANDP));
```

```
OR4 or4p (.A(orp_a), .B(orp_b), .C(orp_c), .D(orp_d), .Y(ORP));
```

```
AND4 and4c (.A(andc_a), .B(andc_b), .C(andc_c), .D(andc_d), .Y(ANDC));
```

```

OR4 or4c (.A(orc_a), .B(orc_b), .C(orc_c), .D(orc_d), .Y(ORC));

endmodule

// FF32
`timescale 1 ns/100 ps
module FF32 (D, Q, CLK, RST, ANDP, ORP, ANDC, ORC);

input D, CLK, RST;
output Q, ANDP, ORP, ANDC, ORC;

wire x1, x2, x3, Q;
wire andp_a, andp_b, andp_c, andp_d, orp_a, orp_b, orp_c, orp_d;
wire andc_a, andc_b, andc_c, andc_d, orc_a, orc_b, orc_c, orc_d;

FF8 dff_a (.D(D), .Q(x1), .CLK(CLK), .RST(RST), .ANDP(andp_a), .ORP(orp_a),
.ANDC(andc_a), .ORC(orc_a));

FF8 dff_b (.D(x1), .Q(x2), .CLK(CLK), .RST(RST), .ANDP(andp_b), .ORP(orp_b),
.ANDC(andc_b), .ORC(orc_b));

FF8 dff_c (.D(x2), .Q(x3), .CLK(CLK), .RST(RST), .ANDP(andp_c), .ORP(orp_c),
.ANDC(andc_c), .ORC(orc_c));

FF8 dff_d (.D(x3), .Q(Q), .CLK(CLK), .RST(RST), .ANDP(andp_d), .ORP(orp_d),
.ANDC(andc_d), .ORC(orc_d));

AND4 and4p (.A(andp_a), .B(andp_b), .C(andp_c), .D(andp_d), .Y(ANDP));
OR4 or4p (.A(orp_a), .B(orp_b), .C(orp_c), .D(orp_d), .Y(ORP));

AND4 and4c (.A(andc_a), .B(andc_b), .C(andc_c), .D(andc_d), .Y(ANDC));
OR4 or4c (.A(orc_a), .B(orc_b), .C(orc_c), .D(orc_d), .Y(ORC));

endmodule

// FF8
`timescale 1 ns/100 ps

module FF8 (D, Q, CLK, RST, ANDP, ORP, ANDC, ORC);

input D, CLK, RST;
output Q, ANDP, ORP, ANDC, ORC;

wire x1, x2, x3, x4, x5, x6, x7;

DFC1B dff1 (.D(D), .Q(x1), .CLK(CLK), .CLR(RST));
DFP1B dff2 (.D(x1), .Q(x2), .CLK(CLK), .PRE(RST));
DFC1B dff3 (.D(x2), .Q(x3), .CLK(CLK), .CLR(RST));
DFP1B dff4 (.D(x3), .Q(x4), .CLK(CLK), .PRE(RST));
DFC1B dff5 (.D(x4), .Q(x5), .CLK(CLK), .CLR(RST));
DFP1B dff6 (.D(x5), .Q(x6), .CLK(CLK), .PRE(RST));
DFC1B dff7 (.D(x6), .Q(x7), .CLK(CLK), .CLR(RST));
DFP1B dff8 (.D(x7), .Q(Q), .CLK(CLK), .PRE(RST));

AND4 and4p (.A(x2), .B(x4), .C(x6), .D(Q), .Y(ANDP));
OR4 or4p (.A(x2), .B(x4), .C(x6), .D(Q), .Y(ORP));

```

```

AND4 and4c (.A(x1), .B(x3), .C(x5), .D(x7), .Y(ANDC));
OR4 or4c (.A(x1), .B(x3), .C(x5), .D(x7), .Y(ORC));

endmodule

// Top_RAM_Module.v
`timescale 1 ns/100 ps

module Top_RAM_Module(Psel0, Psel1, RC_en, RC_clr, RC_clk, Write, Read, Wclk, Rclk,
    Q_RAM);
input Psel0, Psel1, RC_en, RC_clr, RC_clk, Write, Read, Wclk, Rclk;
output [5:0] Q_RAM;

wire Gnd, Vcc;
wire mx0, mx1;
wire [12:0] rc;
wire [3:0] dec;
wire y_0w, y_0r, y_1w, y_1r, y_2w, y_2r, y_3w, y_3r;
// y_4w, y_4r, y_5w, y_5r, y_6w, y_6r, y_7w, y_7r;
wire [5:0] DIN;
wire [5:0] Q_b0;
wire [5:0] Q_b1;
wire [5:0] Q_b2;
wire [5:0] Q_b3;
//wire [5:0] Q_b4;
//wire [5:0] Q_b5;
//wire [5:0] Q_b6;
//wire [5:0] Q_b7;

GND gnd_0(.Y(Gnd));
VCC vcc_0(.Y(Vcc));

mux_2x1 mux_0(.Data0_port(Gnd), .Data1_port(Vcc), .Sel0(Psel0), .Result(mx0));
mux_2x1 mux_1(.Data0_port(Gnd), .Data1_port(Vcc), .Sel0(Psel1), .Result(mx1));

counter_13 counter_0(.Enable(RC_en), .Aclr(RC_clr), .Clock(RC_clk), .Q(rc));

decoder_2to4 decoder_0(.Data0(rc[11]), .Data1(rc[12]), .Eq(dec));

NAND2 nand_0w(.A(dec[0]), .B(Write), .Y(y_0w));
NAND2 nand_0r(.A(dec[0]), .B(Read), .Y(y_0r));

ram_2048x6 ram_blk0(.Data(DIN), .Q(Q_b0), .WAddress(rc[10:0]), .RAddress(rc[10:0]),
    .WE(y_0w), .RE(y_0r), .WClock(Wclk), .RClock(Rclk));

assign DIN[0]=mx0, DIN[1]=mx1, DIN[2]=mx0, DIN[3]=mx1, DIN[4]=mx0, DIN[5]=mx1;

NAND2 nand_1w(.A(dec[1]), .B(Write), .Y(y_1w));
NAND2 nand_1r(.A(dec[1]), .B(Read), .Y(y_1r));

ram_2048x6 ram_blk1(.Data(DIN), .Q(Q_b1), .WAddress(rc[10:0]), .RAddress(rc[10:0]),
    .WE(y_1w), .RE(y_1r), .WClock(Wclk), .RClock(Rclk));

NAND2 nand_2w(.A(dec[2]), .B(Write), .Y(y_2w));
NAND2 nand_2r(.A(dec[2]), .B(Read), .Y(y_2r));

```

```

ram_2048x6 ram_blk2(.Data(DIN),
    .Q(Q_b2), .WAddress(rc[10:0]), .RAddress(rc[10:0]),
    .WE(y_2w), .RE(y_2r), .WClk(Wclk), .RClock(Rclk));

NAND2 nand_3w(.A(dec[3]), .B(Write), .Y(y_3w));
NAND2 nand_3r(.A(dec[3]), .B(Read), .Y(y_3r));

ram_2048x6 ram_blk3(.Data(DIN),
    .Q(Q_b3), .WAddress(rc[10:0]), .RAddress(rc[10:0]),
    .WE(y_3w), .RE(y_3r), .WClk(Wclk), .RClock(Rclk));

/* NAND2 nand_4w(.A(dec[4]), .B(Write), .Y(y_4w));
NAND2 nand_4r(.A(dec[4]), .B(Read), .Y(y_4r));

ram_2048x3 ram_blk4(.Data(DIN),
    .Q(Q_b4), .WAddress(rc[10:0]), .RAddress(rc[10:0]),
    .WE(y_4w), .RE(y_4r), .WClk(Wclk), .RClock(Rclk));

NAND2 nand_5w(.A(dec[5]), .B(Write), .Y(y_5w));
NAND2 nand_5r(.A(dec[5]), .B(Read), .Y(y_5r));

ram_2048x3 ram_blk5(.Data(DIN),
    .Q(Q_b5), .WAddress(rc[10:0]), .RAddress(rc[10:0]),
    .WE(y_5w), .RE(y_5r), .WClk(Wclk), .RClock(Rclk));

NAND2 nand_6w(.A(dec[6]), .B(Write), .Y(y_6w));
NAND2 nand_6r(.A(dec[6]), .B(Read), .Y(y_6r));

ram_2048x3 ram_blk6(.Data(DIN),
    .Q(Q_b6), .WAddress(rc[10:0]), .RAddress(rc[10:0]),
    .WE(y_6w), .RE(y_6r), .WClk(Wclk), .RClock(Rclk));

NAND2 nand_7w(.A(dec[7]), .B(Write), .Y(y_7w));
NAND2 nand_7r(.A(dec[7]), .B(Read), .Y(y_7r));

ram_2048x3 ram_blk7(.Data(DIN),
    .Q(Q_b7), .WAddress(rc[10:0]), .RAddress(rc[10:0]),
    .WE(y_7w), .RE(y_7r), .WClk(Wclk), .RClock(Rclk)); */

mux_6x4 mux_6x4_0(.Data0_port(Q_b0), .Data1_port(Q_b1), .Data2_port(Q_b2),
    .Data3_port(Q_b3), .Sel0(rc[11]),
    .Sel1(rc[12]), .Result(Q_RAM));

endmodule

```

```
`timescale 1 ns/100 ps
// Version: 6.0 SP3 6.0.30.3
```

```
module mux_2x1(Data0_port,Data1_port,Sel0,Result);
input Data0_port, Data1_port, Sel0;
output Result;
```

```
    MX2 MX2_Result(.A(Data0_port), .B(Data1_port), .S(Sel0), .Y(
        Result));
```

```
endmodule
```

```
`timescale 1 ns/100 ps
// Version: 6.2 SP2 6.2.52.7
```

```
module counter_13(Enable,Aclr,Clock,Q);
input Enable, Aclr, Clock;
output [12:0] Q;
```

```
    wire ClrAux_0_net, ClrAux_7_net, MX2_1_Y, MX2_7_Y, MX2_4_Y,
        CM8_0_Y, MX2_10_Y, MX2_9_Y, MX2_3_Y, MX2_5_Y, MX2_6_Y,
        MX2_0_Y, MX2_8_Y, MX2_2_Y, MX2_11_Y, VCC, GND;
```

```
    VCC VCC_1_net(.Y(VCC));
    GND GND_1_net(.Y(GND));
    DFC1D DFC1D_Q_7_inst(.D(MX2_1_Y), .CLK(Q[6]), .CLR(
        ClrAux_7_net), .Q(Q[7]));
    DFC1D DFC1D_Q_1_inst(.D(MX2_7_Y), .CLK(Q[0]), .CLR(
        ClrAux_0_net), .Q(Q[1]));
    BUFF BUFF_ClrAux_0_inst(.A(Aclr), .Y(ClrAux_0_net));
    MX2 MX2_9(.A(VCC), .B(GND), .S(Q[5]), .Y(MX2_9_Y));
    DFC1D DFC1D_Q_2_inst(.D(MX2_6_Y), .CLK(Q[1]), .CLR(
        ClrAux_0_net), .Q(Q[2]));
    MX2 MX2_0(.A(VCC), .B(GND), .S(Q[8]), .Y(MX2_0_Y));
    DFC1D DFC1D_Q_12_inst(.D(MX2_4_Y), .CLK(Q[11]), .CLR(
        ClrAux_7_net), .Q(Q[12]));
    DFC1D DFC1D_Q_3_inst(.D(MX2_11_Y), .CLK(Q[2]), .CLR(
        ClrAux_0_net), .Q(Q[3]));
    DFC1D DFC1D_Q_4_inst(.D(MX2_5_Y), .CLK(Q[3]), .CLR(
        ClrAux_0_net), .Q(Q[4]));
    CM8 CM8_0(.D0(GND), .D1(VCC), .D2(VCC), .D3(GND), .S00(Q[0]),
        .S01(VCC), .S10(Enable), .S11(GND), .Y(CM8_0_Y));
    MX2 MX2_11(.A(VCC), .B(GND), .S(Q[3]), .Y(MX2_11_Y));
    DFC1B DFC1B_Q_0_inst(.D(CM8_0_Y), .CLK(Clock), .CLR(
        ClrAux_0_net), .Q(Q[0]));
    MX2 MX2_6(.A(VCC), .B(GND), .S(Q[2]), .Y(MX2_6_Y));
    MX2 MX2_3(.A(VCC), .B(GND), .S(Q[10]), .Y(MX2_3_Y));
    DFC1D DFC1D_Q_11_inst(.D(MX2_10_Y), .CLK(Q[10]), .CLR(
        ClrAux_7_net), .Q(Q[11]));
    MX2 MX2_10(.A(VCC), .B(GND), .S(Q[11]), .Y(MX2_10_Y));
    BUFF BUFF_ClrAux_7_inst(.A(Aclr), .Y(ClrAux_7_net));
    MX2 MX2_4(.A(VCC), .B(GND), .S(Q[12]), .Y(MX2_4_Y));
    DFC1D DFC1D_Q_5_inst(.D(MX2_9_Y), .CLK(Q[4]), .CLR(
```

```

    ClrAux_0_net), .Q(Q[5]));
DFC1D DFC1D_Q_9_inst(.D(MX2_8_Y), .CLK(Q[8]), .CLR(
    ClrAux_7_net), .Q(Q[9]));
MX2 MX2_5(.A(VCC), .B(GND), .S(Q[4]), .Y(MX2_5_Y));
MX2 MX2_8(.A(VCC), .B(GND), .S(Q[9]), .Y(MX2_8_Y));
DFC1D DFC1D_Q_8_inst(.D(MX2_0_Y), .CLK(Q[7]), .CLR(
    ClrAux_7_net), .Q(Q[8]));
MX2 MX2_2(.A(VCC), .B(GND), .S(Q[6]), .Y(MX2_2_Y));
MX2 MX2_7(.A(VCC), .B(GND), .S(Q[1]), .Y(MX2_7_Y));
MX2 MX2_1(.A(VCC), .B(GND), .S(Q[7]), .Y(MX2_1_Y));
DFC1D DFC1D_Q_6_inst(.D(MX2_2_Y), .CLK(Q[5]), .CLR(
    ClrAux_0_net), .Q(Q[6]));
DFC1D DFC1D_Q_10_inst(.D(MX2_3_Y), .CLK(Q[9]), .CLR(
    ClrAux_7_net), .Q(Q[10]));

endmodule

`timescale 1 ns/100 ps
// Version: 6.2 SP2 6.2.52.7

module decoder_2to4(Data0,Data1,Eq);
input Data0, Data1;
output [3:0] Eq;

    AND2A AND2A_Eq_1_inst(.A(Data1), .B(Data0), .Y(Eq[1]));
    AND2 AND2_Eq_3_inst(.A(Data0), .B(Data1), .Y(Eq[3]));
    AND2A AND2A_Eq_2_inst(.A(Data0), .B(Data1), .Y(Eq[2]));
    AND2B AND2B_Eq_0_inst(.A(Data0), .B(Data1), .Y(Eq[0]));

endmodule

`timescale 1 ns/100 ps
// Version: 6.2 SP2 6.2.52.7

module ram_2048x6(Data,Q,WAddress,RAddress,WE,RE,WClock,RClock);
input [5:0] Data;
output [5:0] Q;
input [10:0] WAddress, RAddress;
input WE, RE, WClock, RClock;

    wire WEP, REP, VCC, GND;

    VCC VCC_1_net(.Y(VCC));
    GND GND_1_net(.Y(GND));
    RAM64K36P ram_2048x6_R0C2(.WCLK(WClock), .RCLK(RClock),
        .DEPTH0(GND), .DEPTH1(GND), .DEPTH2(GND), .DEPTH3(GND),
        .WEN(WEP), .WW0(VCC), .WW1(GND), .WW2(GND), .WRAD0(
        WAddress[0]), .WRAD1(WAddress[1]), .WRAD2(WAddress[2]),
        .WRAD3(WAddress[3]), .WRAD4(WAddress[4]), .WRAD5(
        WAddress[5]), .WRAD6(WAddress[6]), .WRAD7(WAddress[7]),
        .WRAD8(WAddress[8]), .WRAD9(WAddress[9]), .WRAD10(
        WAddress[10]), .WRAD11(GND), .WRAD12(GND), .WRAD13(GND),
        .WRAD14(GND), .WRAD15(GND), .WD0(Data[4]), .WD1(Data[5]),

```

```

.WD2(GND), .WD3(GND), .WD4(GND), .WD5(GND), .WD6(GND),
.WD7(GND), .WD8(GND), .WD9(GND), .WD10(GND), .WD11(GND),
.WD12(GND), .WD13(GND), .WD14(GND), .WD15(GND), .WD16(GND)
, .WD17(GND), .WD18(GND), .WD19(GND), .WD20(GND), .WD21(
GND), .WD22(GND), .WD23(GND), .WD24(GND), .WD25(GND),
.WD26(GND), .WD27(GND), .WD28(GND), .WD29(GND), .WD30(GND)
, .WD31(GND), .WD32(GND), .WD33(GND), .WD34(GND), .WD35(
GND), .REN(REP), .RW0(VCC), .RW1(GND), .RW2(GND), .RDAD0(
RAddress[0]), .RDAD1(RAddress[1]), .RDAD2(RAddress[2]),
.RDAD3(RAddress[3]), .RDAD4(RAddress[4]), .RDAD5(
RAddress[5]), .RDAD6(RAddress[6]), .RDAD7(RAddress[7]),
.RDAD8(RAddress[8]), .RDAD9(RAddress[9]), .RDAD10(
RAddress[10]), .RDAD11(GND), .RDAD12(GND), .RDAD13(GND),
.RDAD14(GND), .RDAD15(GND), .RD0(Q[4]), .RD1(Q[5]), .RD2()
, .RD3(), .RD4(), .RD5(), .RD6(), .RD7(), .RD8(), .RD9(),
.RD10(), .RD11(), .RD12(), .RD13(), .RD14(), .RD15(),
.RD16(), .RD17(), .RD18(), .RD19(), .RD20(), .RD21(),
.RD22(), .RD23(), .RD24(), .RD25(), .RD26(), .RD27(),
.RD28(), .RD29(), .RD30(), .RD31(), .RD32(), .RD33(),
.RD34(), .RD35());
INV REBUBBLE(.A(RE), .Y(REP));
INV WEBUBBLE(.A(WE), .Y(WEP));
RAM64K36P ram_2048x6_R0C1(.WCLK(WClock), .RCLK(RClock),
.DEPTH0(GND), .DEPTH1(GND), .DEPTH2(GND), .DEPTH3(GND),
.WEN(WEP), .WW0(VCC), .WW1(GND), .WW2(GND), .WRAD0(
WAddress[0]), .WRAD1(WAddress[1]), .WRAD2(WAddress[2]),
.WRAD3(WAddress[3]), .WRAD4(WAddress[4]), .WRAD5(
WAddress[5]), .WRAD6(WAddress[6]), .WRAD7(WAddress[7]),
.WRAD8(WAddress[8]), .WRAD9(WAddress[9]), .WRAD10(
WAddress[10]), .WRAD11(GND), .WRAD12(GND), .WRAD13(GND),
.WRAD14(GND), .WRAD15(GND), .WD0(Data[2]), .WD1(Data[3]),
.WD2(GND), .WD3(GND), .WD4(GND), .WD5(GND), .WD6(GND),
.WD7(GND), .WD8(GND), .WD9(GND), .WD10(GND), .WD11(GND),
.WD12(GND), .WD13(GND), .WD14(GND), .WD15(GND), .WD16(GND)
, .WD17(GND), .WD18(GND), .WD19(GND), .WD20(GND), .WD21(
GND), .WD22(GND), .WD23(GND), .WD24(GND), .WD25(GND),
.WD26(GND), .WD27(GND), .WD28(GND), .WD29(GND), .WD30(GND)
, .WD31(GND), .WD32(GND), .WD33(GND), .WD34(GND), .WD35(
GND), .REN(REP), .RW0(VCC), .RW1(GND), .RW2(GND), .RDAD0(
RAddress[0]), .RDAD1(RAddress[1]), .RDAD2(RAddress[2]),
.RDAD3(RAddress[3]), .RDAD4(RAddress[4]), .RDAD5(
RAddress[5]), .RDAD6(RAddress[6]), .RDAD7(RAddress[7]),
.RDAD8(RAddress[8]), .RDAD9(RAddress[9]), .RDAD10(
RAddress[10]), .RDAD11(GND), .RDAD12(GND), .RDAD13(GND),
.RDAD14(GND), .RDAD15(GND), .RD0(Q[2]), .RD1(Q[3]), .RD2()
, .RD3(), .RD4(), .RD5(), .RD6(), .RD7(), .RD8(), .RD9(),
.RD10(), .RD11(), .RD12(), .RD13(), .RD14(), .RD15(),
.RD16(), .RD17(), .RD18(), .RD19(), .RD20(), .RD21(),
.RD22(), .RD23(), .RD24(), .RD25(), .RD26(), .RD27(),
.RD28(), .RD29(), .RD30(), .RD31(), .RD32(), .RD33(),
.RD34(), .RD35());
RAM64K36P ram_2048x6_R0C0(.WCLK(WClock), .RCLK(RClock),
.DEPTH0(GND), .DEPTH1(GND), .DEPTH2(GND), .DEPTH3(GND),
.WEN(WEP), .WW0(VCC), .WW1(GND), .WW2(GND), .WRAD0(
WAddress[0]), .WRAD1(WAddress[1]), .WRAD2(WAddress[2]),
.WRAD3(WAddress[3]), .WRAD4(WAddress[4]), .WRAD5(

```



```

WAddress[5]), .WRAD6(WAddress[6]), .WRAD7(WAddress[7]),
.WRAD8(WAddress[8]), .WRAD9(WAddress[9]), .WRAD10(
WAddress[10]), .WRAD11(GND), .WRAD12(GND), .WRAD13(GND),
.WRAD14(GND), .WRAD15(GND), .WD0(Data[0]), .WD1(Data[1]),
.WD2(GND), .WD3(GND), .WD4(GND), .WD5(GND), .WD6(GND),
.WD7(GND), .WD8(GND), .WD9(GND), .WD10(GND), .WD11(GND),
.WD12(GND), .WD13(GND), .WD14(GND), .WD15(GND), .WD16(GND)
, .WD17(GND), .WD18(GND), .WD19(GND), .WD20(GND), .WD21(
GND), .WD22(GND), .WD23(GND), .WD24(GND), .WD25(GND),
.WD26(GND), .WD27(GND), .WD28(GND), .WD29(GND), .WD30(GND)
, .WD31(GND), .WD32(GND), .WD33(GND), .WD34(GND), .WD35(
GND), .REN(REP), .RW0(VCC), .RW1(GND), .RW2(GND), .RDAD0(
RAddress[0]), .RDAD1(RAddress[1]), .RDAD2(RAddress[2]),
.RDAD3(RAddress[3]), .RDAD4(RAddress[4]), .RDAD5(
RAddress[5]), .RDAD6(RAddress[6]), .RDAD7(RAddress[7]),
.RDAD8(RAddress[8]), .RDAD9(RAddress[9]), .RDAD10(
RAddress[10]), .RDAD11(GND), .RDAD12(GND), .RDAD13(GND),
.RDAD14(GND), .RDAD15(GND), .RD0(Q[0]), .RD1(Q[1]), .RD2(
, .RD3(), .RD4(), .RD5(), .RD6(), .RD7(), .RD8(), .RD9(),
.RD10(), .RD11(), .RD12(), .RD13(), .RD14(), .RD15(),
.RD16(), .RD17(), .RD18(), .RD19(), .RD20(), .RD21(),
.RD22(), .RD23(), .RD24(), .RD25(), .RD26(), .RD27(),
.RD28(), .RD29(), .RD30(), .RD31(), .RD32(), .RD33(),
.RD34(), .RD35());

```

```
endmodule
```

```
`timescale 1 ns/100 ps
```

```
// Version: 6.2 SP2 6.2.52.7
```

```
module mux_6x4(Data0_port,Data1_port,Data2_port,Data3_port,Sel0,
Sel1,Result);
```

```
input [5:0] Data0_port, Data1_port, Data2_port, Data3_port;
```

```
input Sel0, Sel1;
```

```
output [5:0] Result;
```

```
MX4 MX4_Result_0_inst(.D0(Data0_port[0]), .D1(Data1_port[0]),
.D2(Data2_port[0]), .D3(Data3_port[0]), .S0(Sel0), .S1(
Sel1), .Y(Result[0]));
```

```
MX4 MX4_Result_2_inst(.D0(Data0_port[2]), .D1(Data1_port[2]),
.D2(Data2_port[2]), .D3(Data3_port[2]), .S0(Sel0), .S1(
Sel1), .Y(Result[2]));
```

```
MX4 MX4_Result_5_inst(.D0(Data0_port[5]), .D1(Data1_port[5]),
.D2(Data2_port[5]), .D3(Data3_port[5]), .S0(Sel0), .S1(
Sel1), .Y(Result[5]));
```

```
MX4 MX4_Result_1_inst(.D0(Data0_port[1]), .D1(Data1_port[1]),
.D2(Data2_port[1]), .D3(Data3_port[1]), .S0(Sel0), .S1(
Sel1), .Y(Result[1]));
```

```
MX4 MX4_Result_4_inst(.D0(Data0_port[4]), .D1(Data1_port[4]),
.D2(Data2_port[4]), .D3(Data3_port[4]), .S0(Sel0), .S1(
Sel1), .Y(Result[4]));
```

```
MX4 MX4_Result_3_inst(.D0(Data0_port[3]), .D1(Data1_port[3]),
.D2(Data2_port[3]), .D3(Data3_port[3]), .S0(Sel0), .S1(
Sel1), .Y(Result[3]));
```

```
endmodule
```