

MSC2X101_100DC120J SiC Diode Power Module

1 Product Overview

This section provides the product overview for the MSC2X101_100DC120J device.

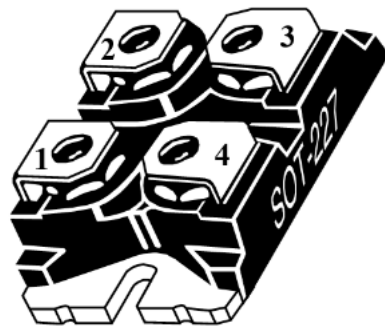
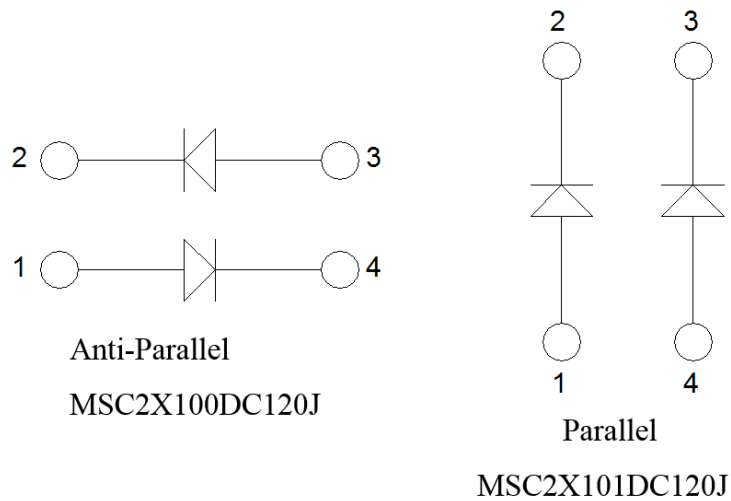

All ratings at $T_j = 25\text{ }^\circ\text{C}$, unless otherwise specified.

Caution: These devices are sensitive to electrostatic discharge. Proper handling procedures should be followed.

1.1 Features

The following are key features of the MSC2X101_100DC120J device:

- Silicon carbide (SiC) Schottky diode
 - Zero reverse recovery
 - Zero forward recovery
 - Temperature-independent switching behavior
 - Positive temperature coefficient on VF
- Very low stray inductance

1.2 Benefits

The following are benefits of the MSC2X101_100DC120J device:

- Outstanding performance at high-frequency operation
- Direct mounting to heatsink (isolated package)
- Low junction-to-case thermal resistance
- RoHS compliant

1.3 Applications

The MSC2X101_100DC120J device is designed for the following applications:

- Uninterruptible power supply (UPS)
- Induction heating
- Welding equipment
- High-speed rectifiers

2 Electrical Specifications

This section provides the electrical specifications for the MSC2X101_100DC120J device.

2.1 Absolute Maximum Ratings

The following table shows the absolute maximum ratings per diode for the MSC2X101_100DC120J device.

Table 1 • Absolute Maximum Ratings

Symbol	Parameter	Maximum Ratings	Unit
V_{RRM}	Repetitive peak reverse voltage	1200	V
I_F	DC forward current	$T_C = 100\text{ }^\circ\text{C}$ 100	A

The following table shows the thermal and package characteristics of the MSC2X101_100DC120J.

Table 2 • Thermal and Package Characteristics

Symbol	Characteristic	Min	Typ	Max	Unit
V_{ISOL}	RMS isolation voltage, any terminal to case $t = 1$ minute, 50 Hz/60 Hz	2500			V
T_{JSTG}	Storage temperature range	-55		175	$^\circ\text{C}$
T_{JOP}	Recommended junction temperature under switching conditions	-55		$T_{Jmax} - 25$	
Torque	Terminal and mounting screws			1.1	N.m
Wt	Package weight		29.2		g

2.2 Electrical Performance

The following table shows the electrical characteristics per diode of the MSC2X101_100DC120J.

Table 3 • Electrical Characteristics Per Diode

Symbol	Characteristic	Test Conditions	Min	Typ	Max	Unit
V_F	Diode forward voltage	$I_F = 100\text{ A}$	$T_j = 25\text{ }^\circ\text{C}$	1.5	1.8	V
			$T_j = 175\text{ }^\circ\text{C}$	2.1		
I_{RM}	Reverse leakage current	$V_R = 1200\text{ V}$	$T_j = 25\text{ }^\circ\text{C}$	30	400	μA
			$T_j = 175\text{ }^\circ\text{C}$	500		
Q_C	Total capacitive charge	$V_R = 600\text{ V}$		448		nC
C	Total capacitance	$f = 1\text{ MHz}, V_R = 400\text{ V}$		492		pF
		$f = 1\text{ MHz}, V_R = 800\text{ V}$		364		
R_{thJC}	Junction-to-case thermal resistance				0.304	$^\circ\text{C/W}$

2.3 Performance Curves

This section shows the typical performance curves for the MSC2X101_100DC120J device.

Figure 1 • Maximum Transient Thermal Impedance

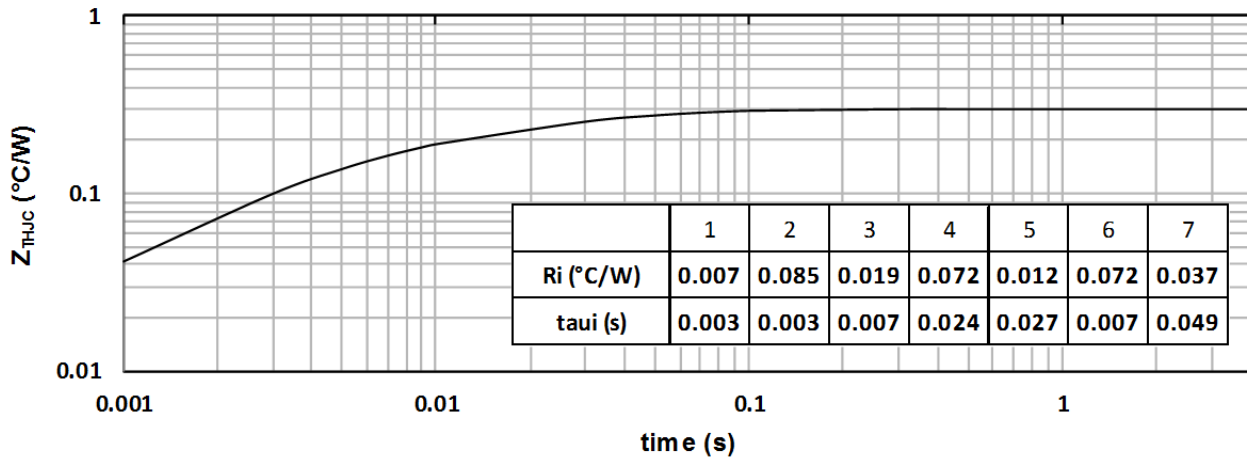

Figure 2 • Forward Current vs. Forward Voltage

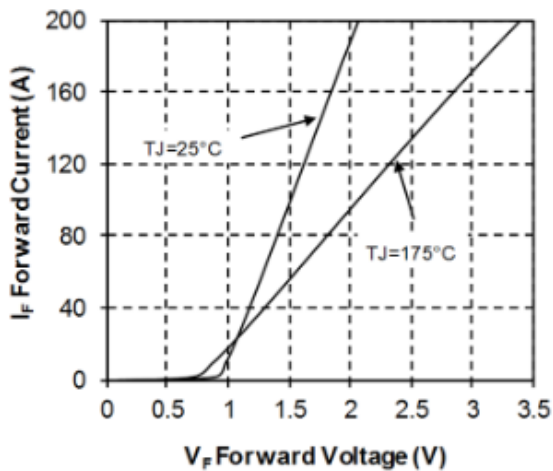
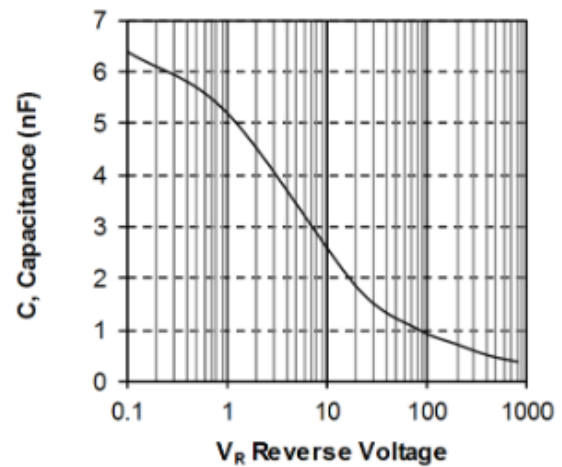

Figure 3 • Capacitance vs. Reverse Voltage



3 Package Specifications

This section shows the package specifications for the MSC2X101_100DC120J device.

3.1 Package Outline Drawing

The following drawing shows the package outline of the MSC2X101_100DC120J device. The dimensions in the following figure are in millimeters.

Figure 4 • Package Outline Drawing

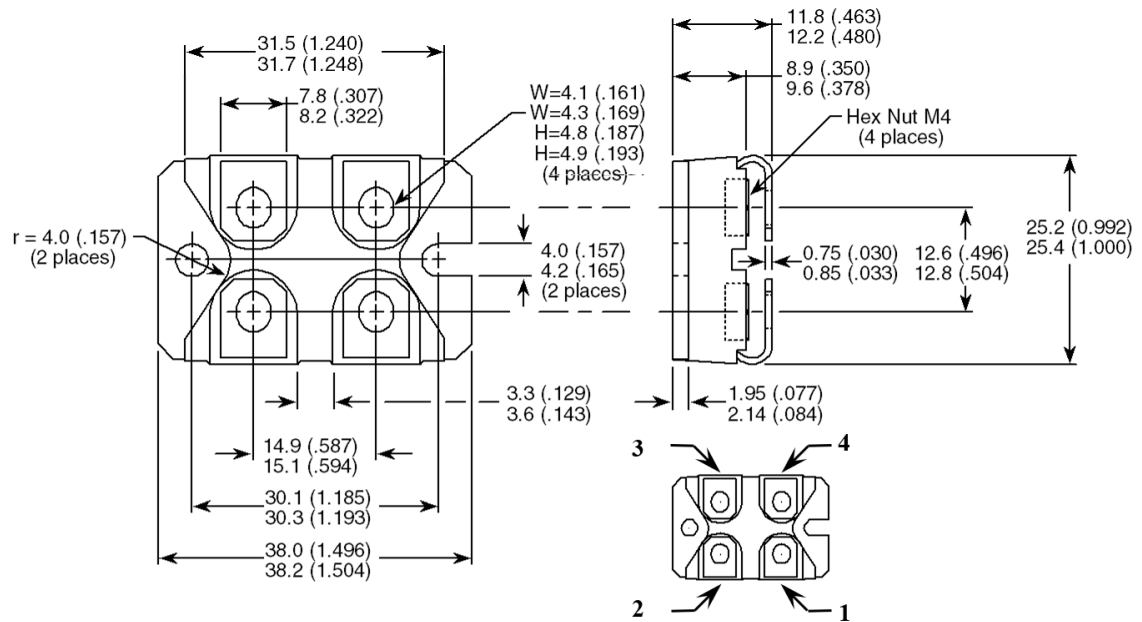

Dimensions in Millimeters and (Inches)



Microsemi Headquarters

One Enterprise, Aliso Viejo,
CA 92656 USA
Within the USA: +1 (800) 713-4113
Outside the USA: +1 (949) 380-6100
Sales: +1 (949) 380-6136
Fax: +1 (949) 215-4996
Email: sales.support@microsemi.com
www.microsemi.com

© 2019 Microsemi. All rights reserved. Microsemi and the Microsemi logo are trademarks of Microsemi Corporation. All other trademarks and service marks are the property of their respective owners.

Microsemi makes no warranty, representation, or guarantee regarding the information contained herein or the suitability of its products and services for any particular purpose, nor does Microsemi assume any liability whatsoever arising out of the application or use of any product or circuit. The products sold hereunder and any other products sold by Microsemi have been subject to limited testing and should not be used in conjunction with mission-critical equipment or applications. Any performance specifications are believed to be reliable but are not verified, and Buyer must conduct and complete all performance and other testing of the products, alone and together with, or installed in, any end-products. Buyer shall not rely on any data and performance specifications or parameters provided by Microsemi. It is the Buyer's responsibility to independently determine suitability of any products and to test and verify the same. The information provided by Microsemi hereunder is provided "as is, where is" and with all faults, and the entire risk associated with such information is entirely with the Buyer. Microsemi does not grant, explicitly or implicitly, to any party any patent rights, licenses, or any other IP rights, whether with regard to such information itself or anything described by such information. Information provided in this document is proprietary to Microsemi, and Microsemi reserves the right to make any changes to the information in this document or to any products and services at any time without notice.

Microsemi, a wholly owned subsidiary of Microchip Technology Inc. (Nasdaq: MCHP), offers a comprehensive portfolio of semiconductor and system solutions for aerospace & defense, communications, data center and industrial markets. Products include high-performance and radiation-hardened analog mixed-signal integrated circuits, FPGAs, SoCs and ASICs; power management products; timing and synchronization devices and precise time solutions, setting the world's standard for time; voice processing devices; RF solutions; discrete components; enterprise storage and communication solutions; security technologies and scalable anti-tamper products; Ethernet solutions; Power-over-Ethernet ICs and midspans; as well as custom design capabilities and services. Microsemi is headquartered in Aliso Viejo, California, and has approximately 4,800 employees globally. Learn more at www.microsemi.com.

MSCC-0344-DS-01015 | June 2019 | Final