

# MSC030SDA120K Zero Recovery Silicon Carbide Schottky Diode

## 1 Product Overview

The silicon carbide (SiC) power Schottky barrier diodes (SBD) product line from Microsemi increases your performance over silicon diode solutions while lowering your total cost of ownership for high-voltage applications. The MSC030SDA120K is a 1200 V, 30 A SiC SBD in a two-lead TO-220 package shown below.

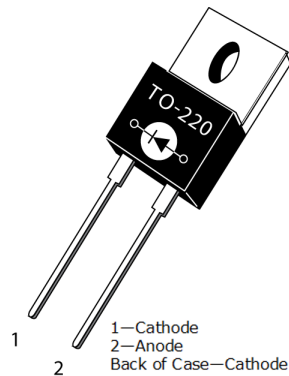

### 1.1 Features

The following are key features of the MSC030SDA120K device:

- Zero recovery characteristics
- Low forward voltage
- Low leakage current
- Avalanche-energy rated
- RoHS compliant

### 1.2 Benefits

The following are benefits of the MSC030SDA120K device:

- High switching frequency
- Low switching losses
- Low noise (EMI) switching
- Higher reliability systems
- Increased system power density

### 1.3 Applications

The MSC030SDA120K device is designed for the following applications:

- Power factor correction (PFC)
- Anti-parallel diode
  - Switch-mode power supply
  - Inverters/converters
  - Motor controllers
- Freewheeling diode
  - Switch-mode power supply
  - Inverters/converters
- Snubber/clamp diode

## 2 Device Specifications

This section shows the specifications of the MSC030SDA120K device.

### 2.1 Absolute Maximum Ratings

The following table shows the absolute maximum ratings of the MSC030SDA120K device.

All ratings are taken at  $T_c = 25\text{ }^\circ\text{C}$  unless otherwise specified.

**Table 1 • Absolute Maximum Ratings**

Symbol	Parameter		Ratings	Unit
$V_R$	Maximum DC reverse voltage		1200	V
$V_{RRM}$	Maximum peak repetitive reverse voltage			
$V_{RWM}$	Maximum working peak reverse voltage			
$I_F$	Maximum DC forward current	$T_c = 25\text{ }^\circ\text{C}$	70	A
		$T_c = 135\text{ }^\circ\text{C}$	32	
		$T_c = 145\text{ }^\circ\text{C}$	27	
$I_{FRM}$	Repetitive peak forward surge current ( $t_p = 8.3\text{ ms}$ , half sine wave)		92	
$I_{FSM}$	Non-repetitive forward surge current ( $t_p = 8.3\text{ ms}$ , half sine wave)		165	
$P_{TOT}$	Power dissipation	$T_c = 25\text{ }^\circ\text{C}$	300	W
		$T_c = 110\text{ }^\circ\text{C}$	130	
$T_J, T_{STG}$	Operating junction and storage temperature range		-55 to 175	$^\circ\text{C}$
$T_L$	Lead temperature for 10 seconds		300	
$E_{AS}$	Single pulse avalanche energy (starting $T_J = 25\text{ }^\circ\text{C}$ , $L = 0.22\text{ mH}$ , peak $I_L = 30\text{ A}$ )		100	mJ

The following table shows the thermal and mechanical characteristics of the MSC030SDA120K device.

**Table 2 • Thermal and Mechanical Characteristics**

Symbol	Characteristic	Min	Typ	Max	Unit
$R_{\theta JC}$	Junction-to-case thermal resistance		0.35	0.50	$^\circ\text{C}/\text{W}$
$Wt$	Package weight		0.07		oz
			1.9		g
	Mounting torque, 6-32 or M3 screw			10	lbf-in
				1.1	N-m

## 2.2 Electrical Performance

The following table shows the static characteristics of the MSC030SDA120K device.

**Table 3 • Static Characteristics**

Symbol	Characteristic	Test Conditions	Min	Typ	Max	Unit
$V_F$	Forward Voltage	$I_F = 30\text{ A}, T_J = 25\text{ °C}$		1.5	1.8	V
		$I_F = 30\text{ A}, T_J = 175\text{ °C}$		2.1		
$I_{RM}$	Reverse leakage current	$V_R = 1200\text{ V}, T_J = 25\text{ °C}$		9	200	$\mu\text{A}$
		$V_R = 1200\text{ V}, T_J = 175\text{ °C}$		150		
$Q_C$	Total capacitive charge	$V_R = 600\text{ V}, T_J = 25\text{ °C}$		130		nC
$C_J$	Junction capacitance	$V_R = 400\text{ V}, T_J = 25\text{ °C}, f = 1\text{ MHz}$		141		pF
	Junction capacitance	$V_R = 800\text{ V}, T_J = 25\text{ °C}, f = 1\text{ MHz}$		105		

## 2.3 Typical Performance Curves

This section shows the typical performance curves of the MSC030SDA120K device.

**Figure 1 • Maximum Transient Thermal Impedance**

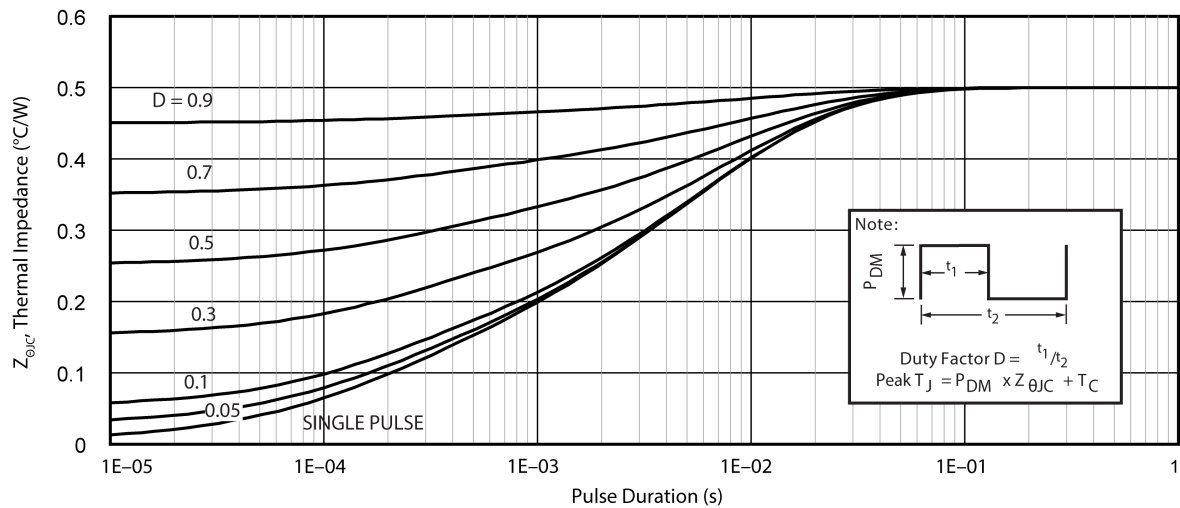

**Figure 2 • Forward Current vs. Forward Voltage**

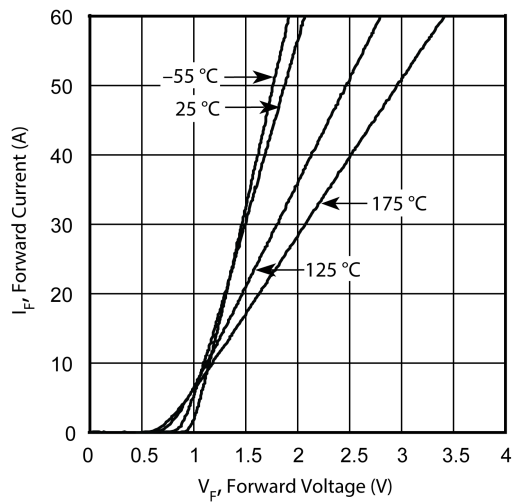

**Figure 3 • Max. Forward Current vs. Case Temp.**

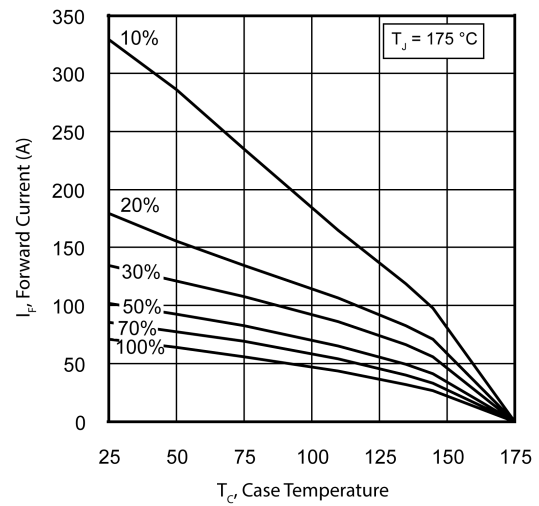

**Figure 4 • Max. Power Dissipation vs. Case Temp.**

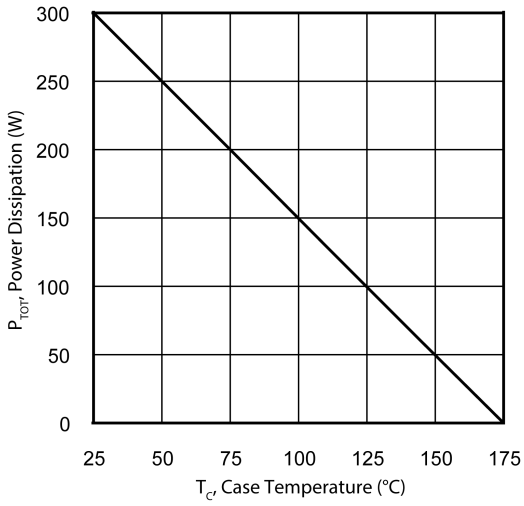

**Figure 5 • Reverse Current vs. Reverse Voltage**

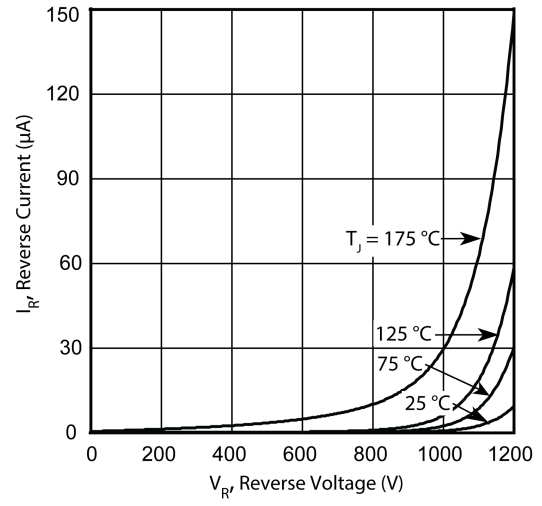

**Figure 6 • Total Capacitive Charge vs. Reverse Voltage**

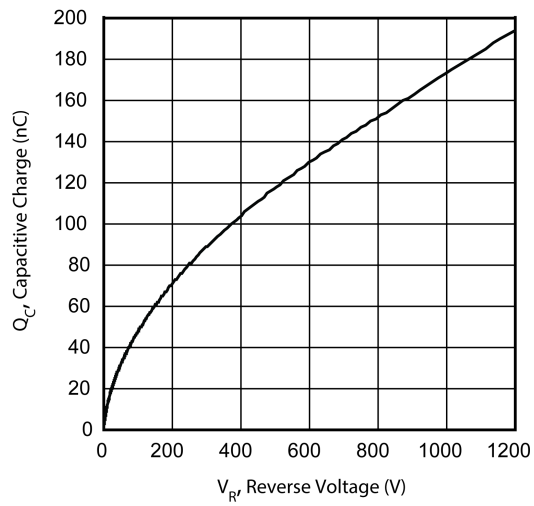

**Figure 7 • Junction Capacitance vs. Reverse Voltage**

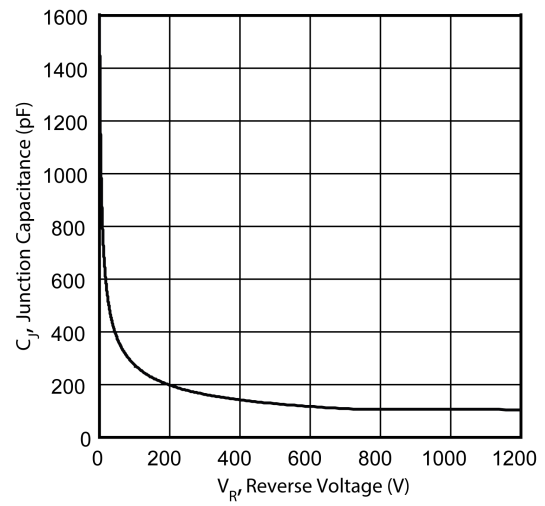

### 3 Package Specification

This section shows the package specification of the MSC030SDA120K device.

#### 3.1 Package Outline Drawing

The following figure illustrates the TO-220 package drawing of the MSC030SDA120K device.

**Figure 8 • Package Outline Drawing**

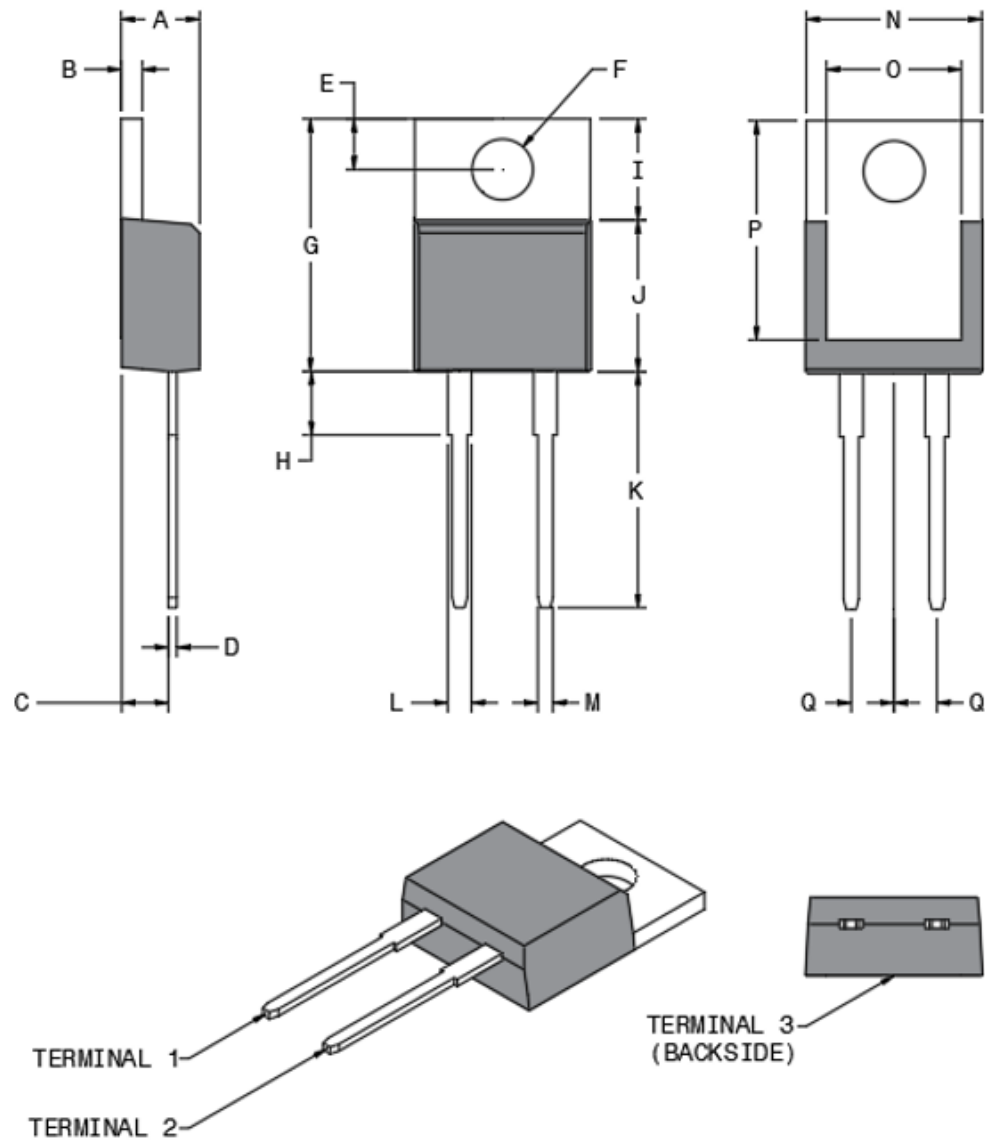

The following table lists the TO-220 dimensions and should be used in conjunction with the package outline drawing.

**Table 4 • TO-220 Dimensions**

Symbol	Min (mm)	Max (mm)	Min (in.)	Max (in.)
A	4.32	4.57	0.170	0.180
B	1.14	1.40	0.045	0.055
C	2.50	2.74	0.098	0.108
D	0.36	0.53	0.014	0.021
E	2.65	3.05	0.104	0.120
F	3.60	3.96	0.142	0.156
G	14.50	15.60	0.571	0.614
H	2.39	3.65	0.094	0.144
I	6.00	6.80	0.236	0.268
J	8.40	9.00	0.331	0.354
K	13.00	14.00	0.512	0.551
L	1.23	1.39	0.048	0.055
M	0.69	0.88	0.027	0.035
N	10.00	10.36	0.394	0.408
O	7.57	7.90	0.298	0.311
P	12.20	13.10	0.480	0.516
Q	2.54 BSC (nom.)		0.100 BSC (nom.)	
Terminal 1	Cathode			
Terminal 2	Anode			
Terminal 3	Cathode			



**Microsemi Headquarters**

One Enterprise, Aliso Viejo,  
CA 92656 USA  
Within the USA: +1 (800) 713-4113  
Outside the USA: +1 (949) 380-6100  
Sales: +1 (949) 380-6136  
Fax: +1 (949) 215-4996  
Email: [sales.support@microsemi.com](mailto:sales.support@microsemi.com)  
[www.microsemi.com](http://www.microsemi.com)

© 2019 Microsemi. All rights reserved. Microsemi and the Microsemi logo are trademarks of Microsemi Corporation. All other trademarks and service marks are the property of their respective owners.

Microsemi makes no warranty, representation, or guarantee regarding the information contained herein or the suitability of its products and services for any particular purpose, nor does Microsemi assume any liability whatsoever arising out of the application or use of any product or circuit. The products sold hereunder and any other products sold by Microsemi have been subject to limited testing and should not be used in conjunction with mission-critical equipment or applications. Any performance specifications are believed to be reliable but are not verified, and Buyer must conduct and complete all performance and other testing of the products, alone and together with, or installed in, any end-products. Buyer shall not rely on any data and performance specifications or parameters provided by Microsemi. It is the Buyer's responsibility to independently determine suitability of any products and to test and verify the same. The information provided by Microsemi hereunder is provided "as is, where is" and with all faults, and the entire risk associated with such information is entirely with the Buyer. Microsemi does not grant, explicitly or implicitly, to any party any patent rights, licenses, or any other IP rights, whether with regard to such information itself or anything described by such information. Information provided in this document is proprietary to Microsemi, and Microsemi reserves the right to make any changes to the information in this document or to any products and services at any time without notice.

Microsemi, a wholly owned subsidiary of Microchip Technology Inc. (Nasdaq: MCHP), offers a comprehensive portfolio of semiconductor and system solutions for aerospace & defense, communications, data center and industrial markets. Products include high-performance and radiation-hardened analog mixed-signal integrated circuits, FPGAs, SoCs and ASICs; power management products; timing and synchronization devices and precise time solutions, setting the world's standard for time; voice processing devices; RF solutions; discrete components; enterprise storage and communication solutions; security technologies and scalable anti-tamper products; Ethernet solutions; Power-over-Ethernet ICs and midspans; as well as custom design capabilities and services. Microsemi is headquartered in Aliso Viejo, California, and has approximately 4,800 employees globally. Learn more at [www.microsemi.com](http://www.microsemi.com).

053-4100 | June 2019 | Released