

**GC4701-6LP Preliminary Datasheet**  
**DC-20GHz Surface Mount Limiter PIN Diode**

Preliminary



Preliminary

Microsemi makes no warranty, representation, or guarantee regarding the information contained herein or the suitability of its products and services for any particular purpose, nor does Microsemi assume any liability whatsoever arising out of the application or use of any product or circuit. The products sold hereunder and any other products sold by Microsemi have been subject to limited testing and should not be used in conjunction with mission-critical equipment or applications. Any performance specifications are believed to be reliable but are not verified, and Buyer must conduct and complete all performance and other testing of the products, alone and together with, or installed in, any end-products. Buyer shall not rely on any data and performance specifications or parameters provided by Microsemi. It is the Buyer's responsibility to independently determine suitability of any products and to test and verify the same. The information provided by Microsemi hereunder is provided "as is, where is" and with all faults, and the entire risk associated with such information is entirely with the Buyer. Microsemi does not grant, explicitly or implicitly, to any party any patent rights, licenses, or any other IP rights, whether with regard to such information itself or anything described by such information. Information provided in this document is proprietary to Microsemi, and Microsemi reserves the right to make any changes to the information in this document or to any products and services at any time without notice.



**Microsemi**  
 Power Matters.™

Microsemi Corporate Headquarters  
 One Enterprise, Aliso Viejo,  
 CA 92656 USA  
 Within the USA: +1 (800) 713-4113  
 Outside the USA: +1 (949) 380-6100  
 Sales: +1 (949) 380-6136  
 Fax: +1 (949) 215-4996  
 E-mail: [sales.support@microsemi.com](mailto:sales.support@microsemi.com)  
[www.microsemi.com](http://www.microsemi.com)

#### About Microsemi

Microsemi Corporation (Nasdaq: MSCC) offers a comprehensive portfolio of semiconductor and system solutions for communications, defense & security, aerospace and industrial markets. Products include high-performance and radiation-hardened analog mixed-signal integrated circuits, FPGAs, SoCs and ASICs; power management products; timing and synchronization devices and precise time solutions, setting the world's standard for time; voice processing devices; RF solutions; discrete components; enterprise storage and communication solutions, security technologies and scalable anti-tamper products; Ethernet solutions; Power-over-Ethernet ICs and midspans; as well as custom design capabilities and services. Microsemi is headquartered in Aliso Viejo, Calif., and has approximately 4,800 employees globally. Learn more at [www.microsemi.com](http://www.microsemi.com).

©2019 Microsemi Corporation. All rights reserved. Microsemi and the Microsemi logo are registered trademarks of Microsemi Corporation. All other trademarks and service marks are the property of their respective owners.

## 1 Product Overview

Figure 1 Functional Block Diagram

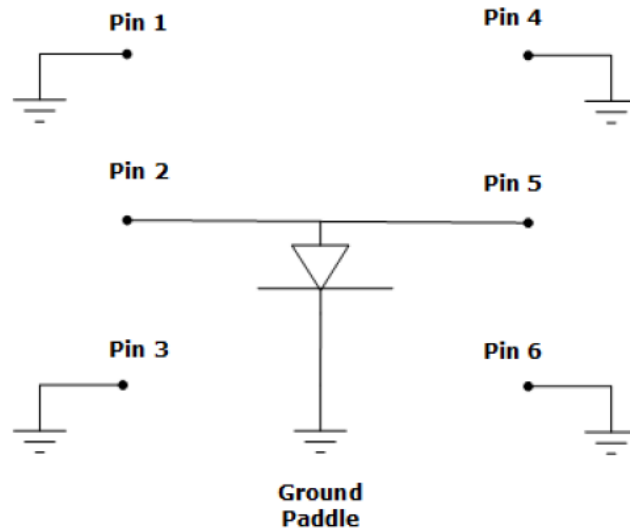

### Key Features

- Small 1.6 mm × 1.6 mm QFN
- Low insertion loss: 0.1 dB at 5 GHz
- Multistage designs
  - GC4212-6LP: Input PIN diode
  - GC4701-6LP: Output PIN diode
  - GC9952-6LP: Schottky driver
- Suitable for applications to 20 GHz
- Excellent flat leakage performance
- Low-P1dB compression point: 10 dBm
- RoHS compliant

### Typical Electrical Performance

Table 1 Device Electrical Parameters

Parameter	Units	Condition	Min	Typ	Max
$V_B$	V	$I_R = 10 \mu\text{A}$		30	
$I_R$	nA	$V_R = 16 \text{ V}$			500
$C_T$	pF	$V_R = 0 \text{ V}, f = 1 \text{ MHz}$		0.45	
$C_T$	pF	$V_R = 10 \text{ V}, f = 1 \text{ MHz}$		0.35	0.4
$R_S$	$\Omega$	$I_F = 10 \text{ mA}, f = 1 \text{ GHz}$		1.5	2
$T_L$	ns	$I_F = 10 \text{ mA}, I_R = 6 \text{ mA}$		10	
Thermal Resistance	$^{\circ}\text{C}/\text{W}$	$I_{\text{heat}} = 0.5 \text{ A}$			50

**Table 2 Device RF Performance**

Parameter	Units	Condition	Min	Typ	Max
Peak Power ( $P_{IN}$ )	dBm	1 $\mu$ s, 0.001 duty cycle			50
Leakage power ( $P_{OUT}$ )	dBm	1 $\mu$ s, 0.001 duty cycle		22	
Threshold	dBm	P1dB		10	
CW power ( $P_{IN}$ )	dBm	Continuous			33
Insertion Loss ( $S_{21}$ )	dB	0 dBm $P_{IN}$ @12 GHz		-0.5	
Return Loss ( $S_{11}$ )	dB	0 dBm $P_{IN}$ @12 GHz		-20	
Frequency Range	GHz	0 dBm $P_{IN}$	0.01		20

## Typical Performance Curves of GC4701-6LP

The following graphs show the typical performance curves of the GC4701-6LP device at 25 °C

Figure 2 S21

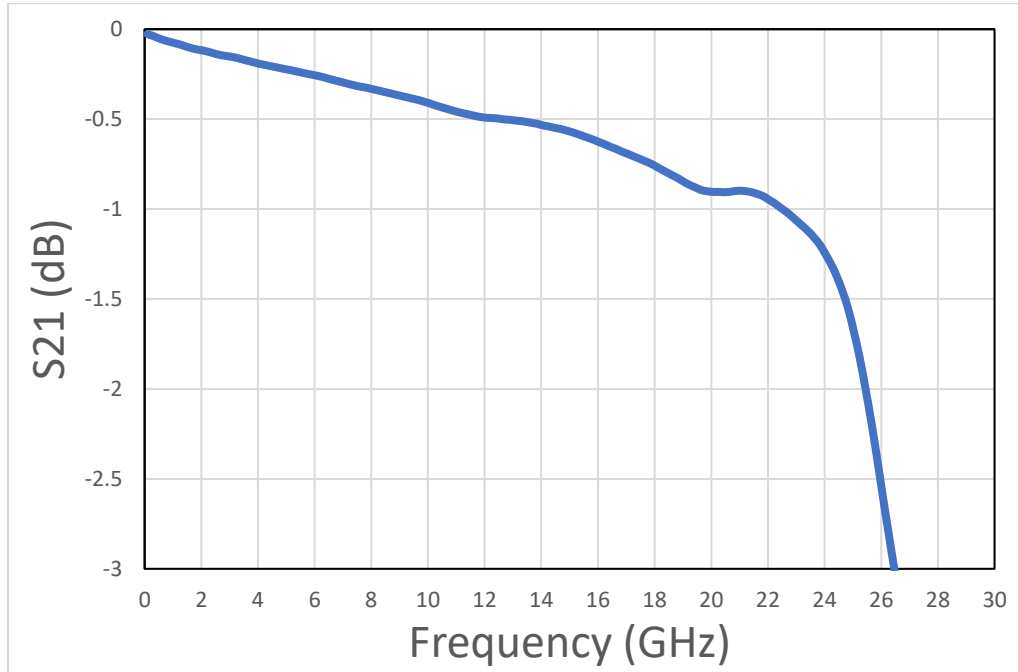

Figure 3 S11

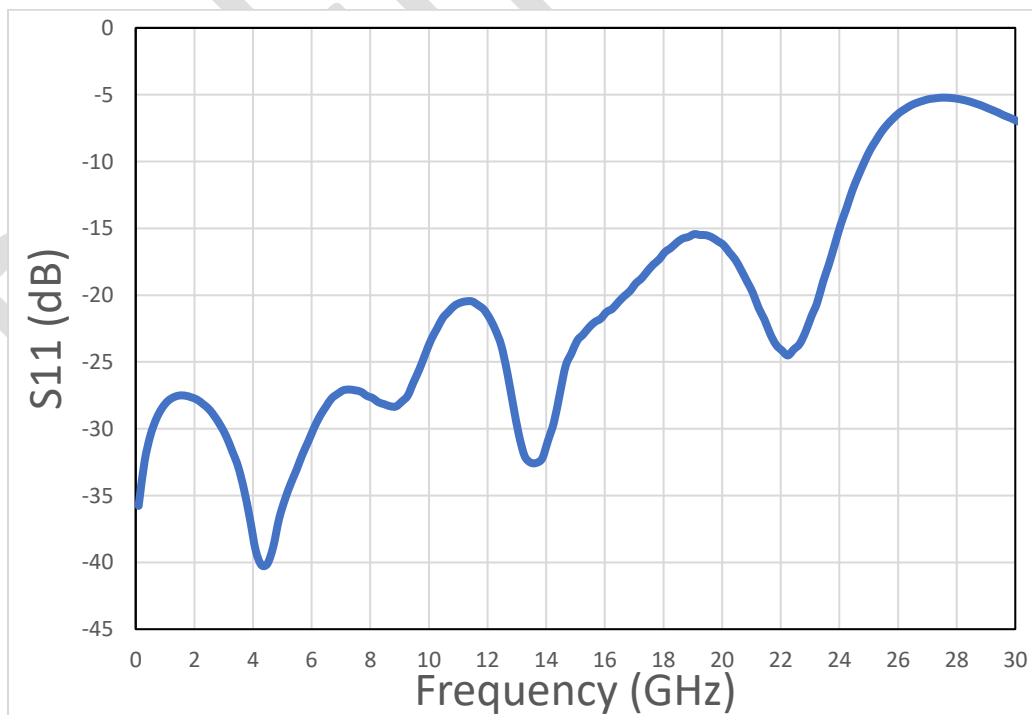

Figure 4 CW Transfer Characteristics

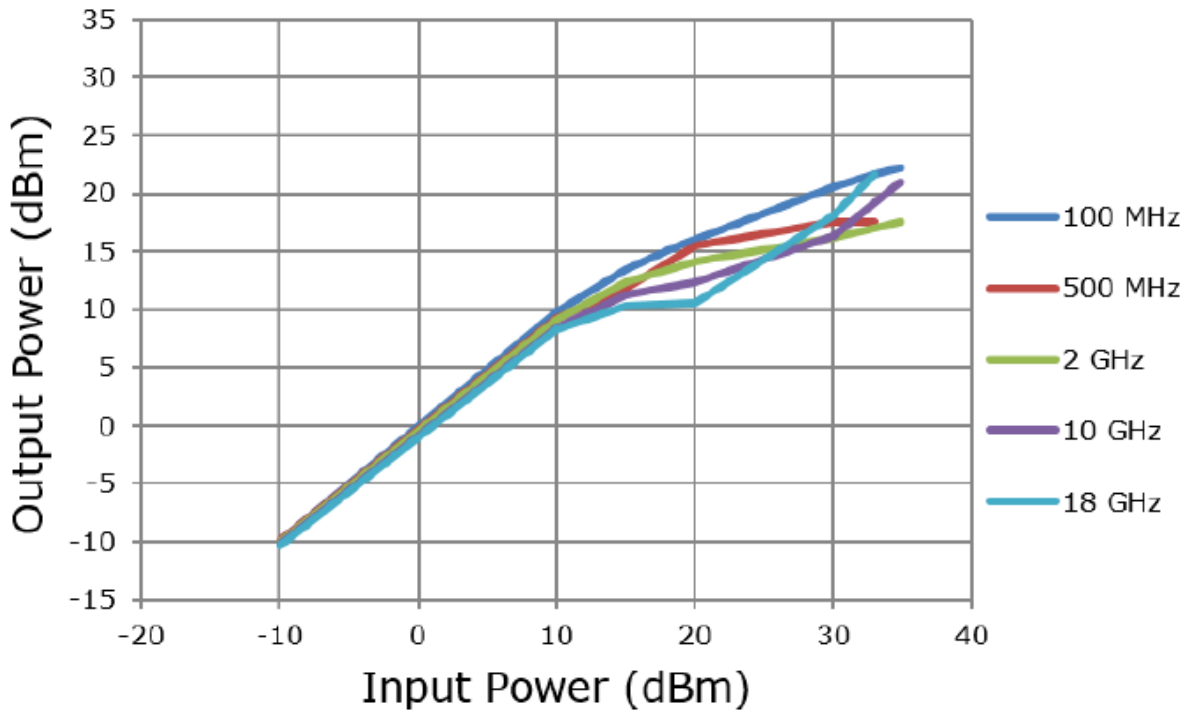
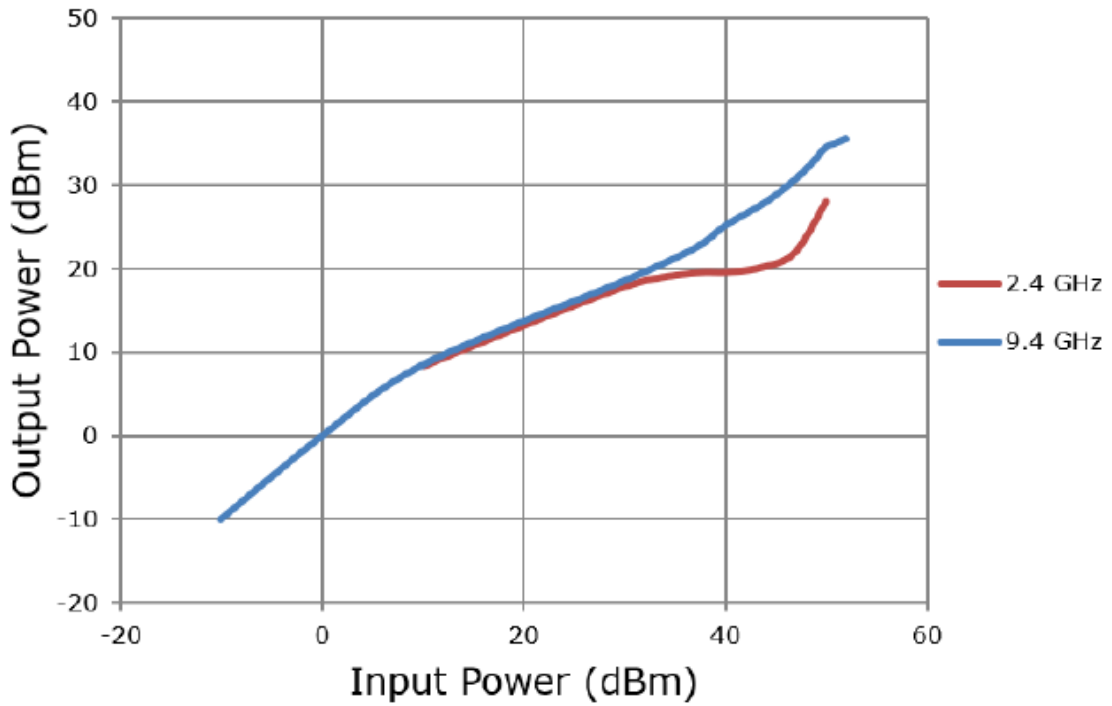

Figure 5 Pulsed Transfer Characteristics



### Typical Performance Curves of the GC4212-6LP and GC4701-6LP

The following graphs show the typical performance curves of the GC4212-6LP input PIN and GC4701-6LP output PIN devices in series at 25 °C

Figure 6 Application Schematic

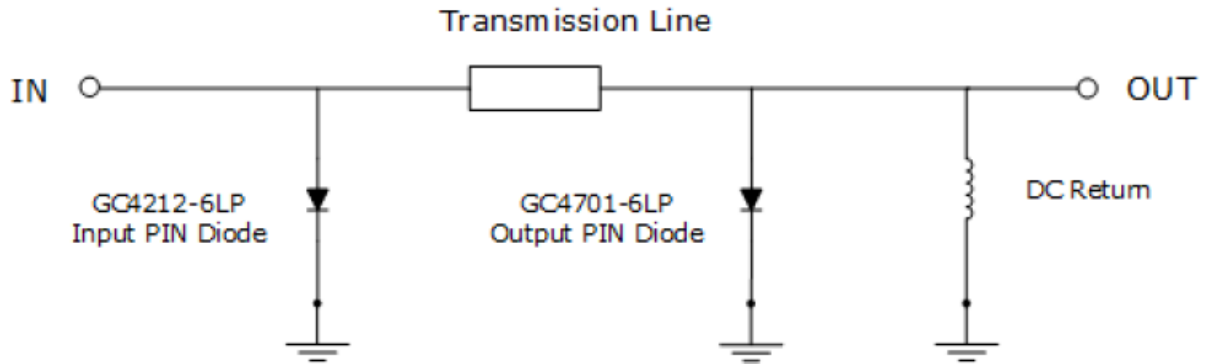

Figure 7 GC4212-6LP and GC4701-6LP CW Multi-Stage Transfer Characteristics

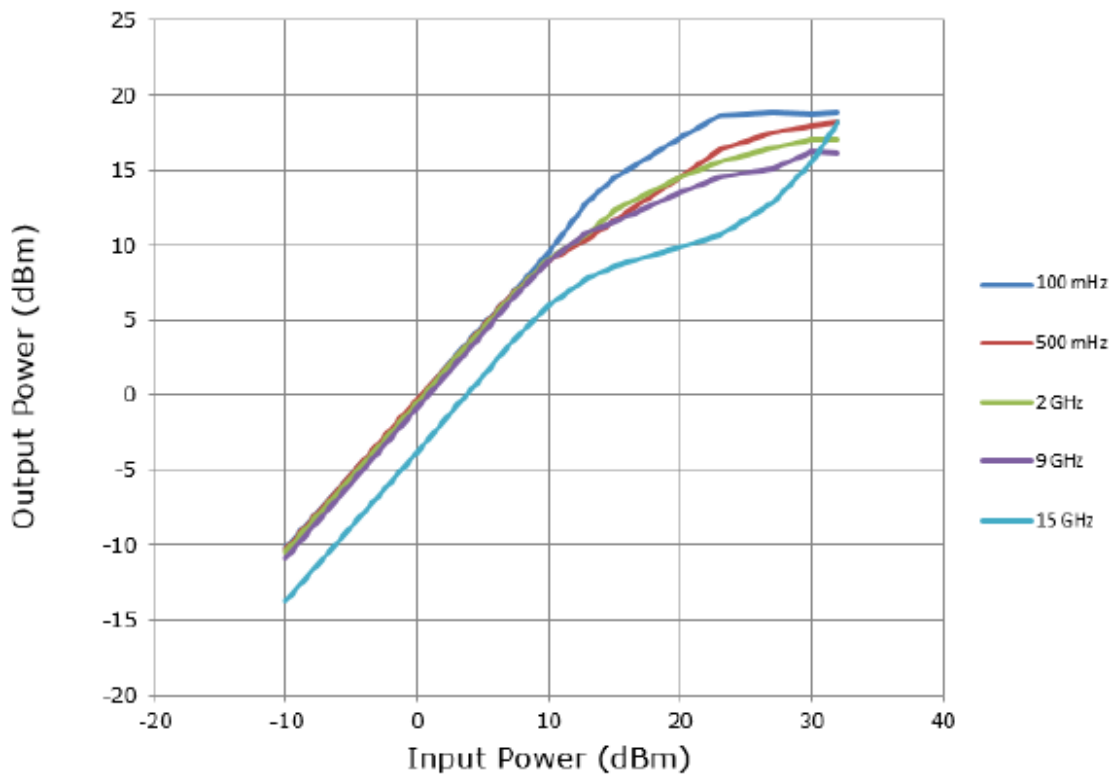
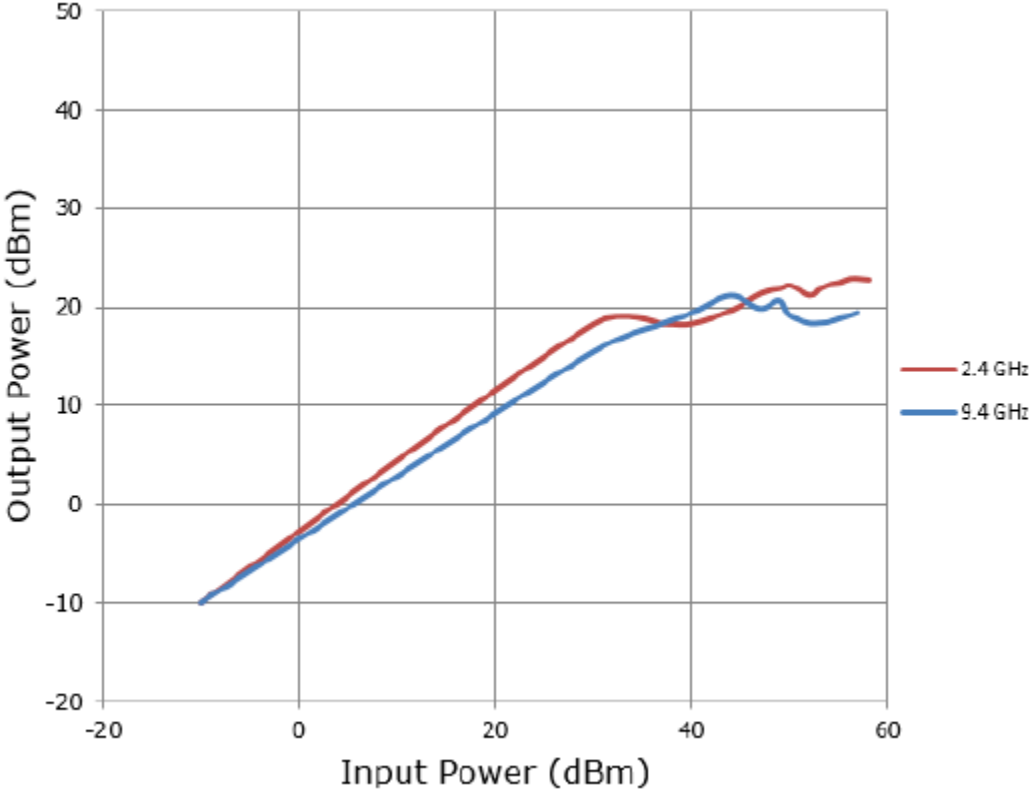

Figure 8 GC4212-6LP and GC4701-6LP Pulsed Multi-Stage Transfer Characteristics



Prelim



### Typical Performance Curves of the GC4212-6LP, GC4701-6LP

The following graphs show the typical performance curves of the GC4212-6LP input PIN and GC4701-6LP output PIN and the GC9952-6LP Schottky driver devices in series at 25 °C

Figure 9 Application Schematic

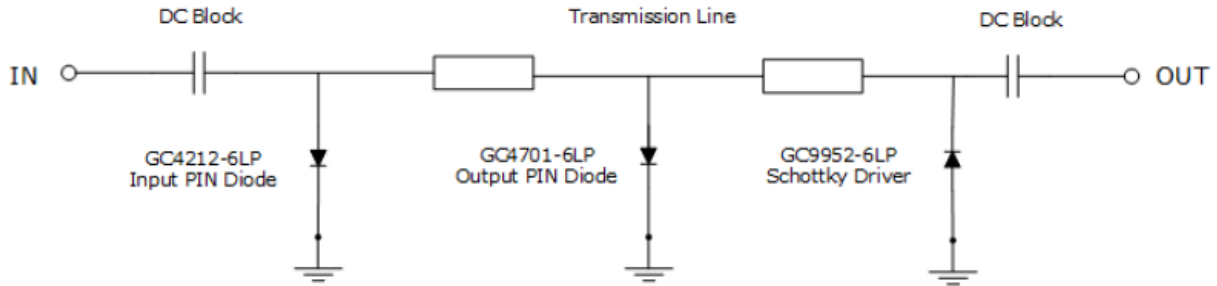

Figure 10 GC4212-6LP, GC4701-6LP, and GC9952-6LP CW Multi-Stage Transfer Characteristics

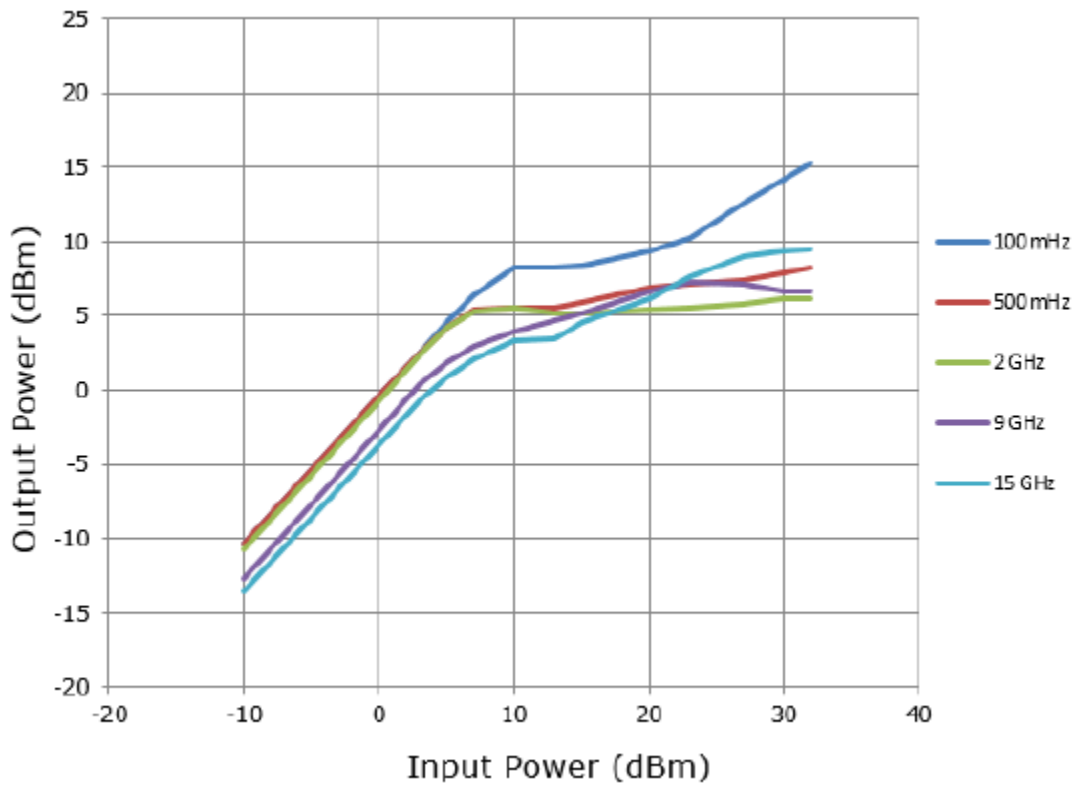
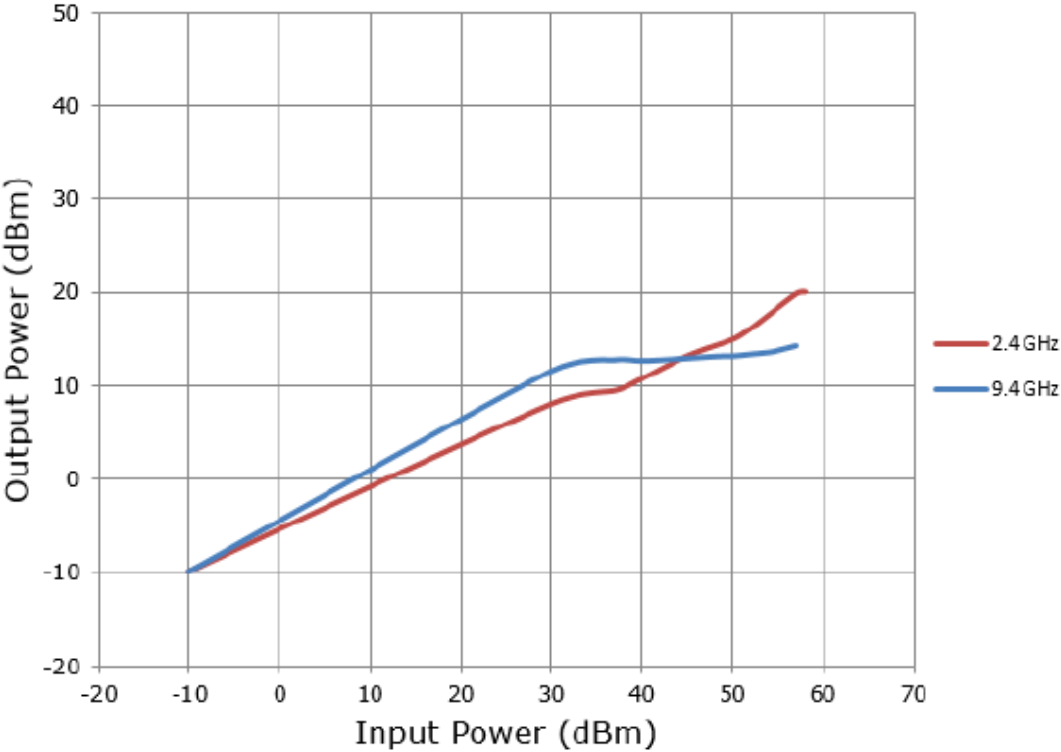

Figure 11 GC4212-6LP, GC4701-6LP, and GC9952-6LP Pulsed Multi-Stage Transfer Characteristics



Preliminary

### Evaluation Board Assembly

