

### DESCRIPTION

The UMX5101 PIN diode series was designed to provide ultra low magnetic PIN diodes for in bore surface coil applications associated with higher field strength (3T and greater) MR scanners. These PIN diodes produce the minimum artifacts (magnetic field distortions) available in the industry, today. The diodes have been tested in magnetic fields of  $\pm 7$  Tesla.

**The UMX5101 PIN diodes have a magnetic moment at 7 T of  $2E-8$  (J/T).**

The diodes are offered in a surface mount package. The SM package utilizes a square end cap to mark the cathode. The anode is round. The fully SOGO passivated PIN diode chip is full face metallurgically bonded to high conductive pins for lower thermal and electrical resistances. The PIN diodes feature low forward bias resistance and high zero bias impedance. The UMX5101 PIN diodes are characterized at 64, 128, and 300 MHz. The UMX5101 meets RoHS requirements per EU Directive 2002/95/EC.

### KEY FEATURES

- Ultra low magnetic construction
- SOGO passivated chip
- Thermally matched configuration
- RoHS compliant <sup>1</sup>
- Low capacitance at 0 V bias
- Low conductance at 0 V bias
- Metallurgical bond
- Fused-in-glass construction
- Non cavity design
- Available in surface mount package.
- Compatible with automatic insertion equipment

1- These devices are supplied with Silver terminations. Other terminal finishes may be available on request. Consult factory for details.

### ABSOLUTE MAXIMUM RATINGS AT 25° C (UNLESS OTHERWISE SPECIFIED)

Rating	Symbol	Value	Unit
Peak Repetitive Reverse Voltage Working Peak Reverse Voltage DC Blocking Voltage	$V_{RRM}$ $V_{RWM}$ $V_R$	100 100 100	V
RMS Reverse Voltage	$V_{R(RMS)}$	75	V
Storage Temperature	T stg	-65 to +175	°C
Operating Temperature Non-Repetitive Peak	T op	-65 to +150	°C

### THERMAL CHARACTERISTICS AT 25° C (UNLESS OTHERWISE SPECIFIED)

Thermal Resistance			
UMX5101SM	$\theta$	20	°C/Watt

### APPLICATIONS/BENEFITS

- High B Field (3T+) in bore APPLICATIONS:
- Active or semi-active (not passive)
- MR blocking circuits
- MR detuning circuits
- MR disable circuits
- MR receiver protector circuits

**IMPORTANT:** For the most current data, consult our website: [www.MICROSEMI.com](http://www.MICROSEMI.com)





# UMX5101

## ULTRA LOW MAGNETIC MOMENT PIN DIODE FOR MRI APPLICATIONS

RoHS COMPLIANT



### ELECTRICAL PARAMETERS @ 25°C (UNLESS OTHERWISE SPECIFIED)

Parameter	Symbol	Conditions	Min	Typ.	Max	Units
Forward Voltage (Note 1)	$V_F$	$I_F = 100 \text{ mA}$		0.82	1.0	V
Reverse Break Down Voltage	$V_{BR}$	$I_R = 10 \text{ uA}$	100			V
Reverse Current	$I_R$	$V_R = 100 \text{ V}$			10	uA
Inductance	$L_S$			800		pH
Magnetic moment	$m$	@ 7T		2E-8		J/T
		@ 1T		5E-8		
Mass Susceptibility	$\chi_p$	@ 7T		-2.7E-11		m <sup>3</sup> /kg
		@ 1T		1.2E-9		
Volume Susceptibility	$\chi$	>1T to 7T		-2.4E-7		SI
		<1 T		1.0E-5		
Capacitance	$C_T$	$V_R = 0 \text{ V}, F = 1 \text{ MHz}$		2.5	3.0	pF
		$V_R = 100 \text{ V}, F = 1 \text{ MHz}$		1.0	1.2	
Parallel Resistance	$R_P$	$V_R = 0 \text{ V}, F = 64 \text{ MHz}$	10	30		kΩ
		$V_R = 30 \text{ V}, F = 64 \text{ MHz}$	800	1000		
Series Resistance	$R_S$	$I_f = 100 \text{ mA}, F = 64 \text{ MHz}$		0.8	1.0	Ω
Lifetime	$\tau$	$I_f = 10 \text{ mA}$	2	2.5		us

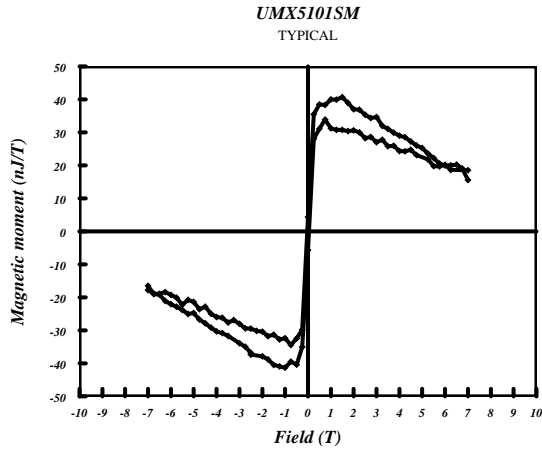
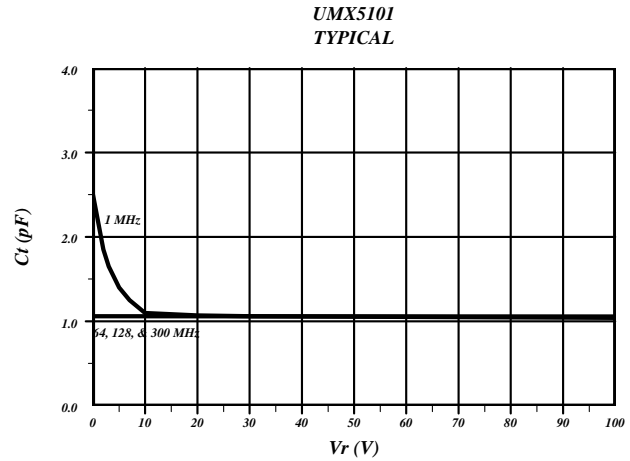
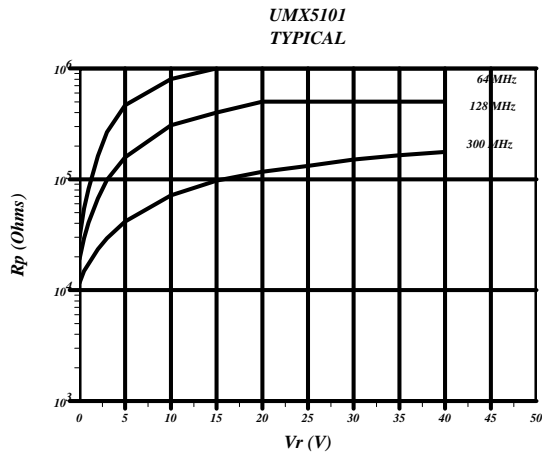
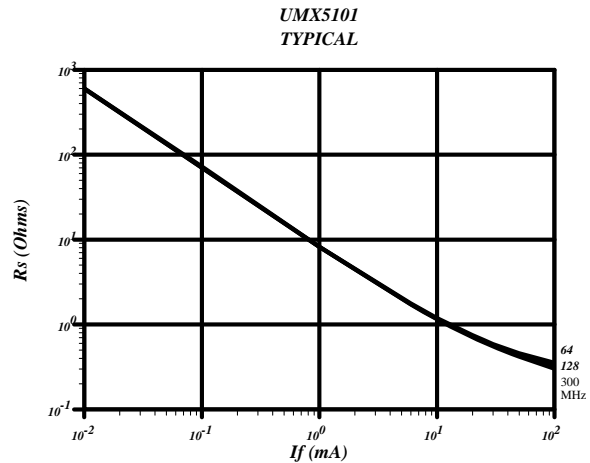
**MAGNETIC MOMENT VS FIELD**

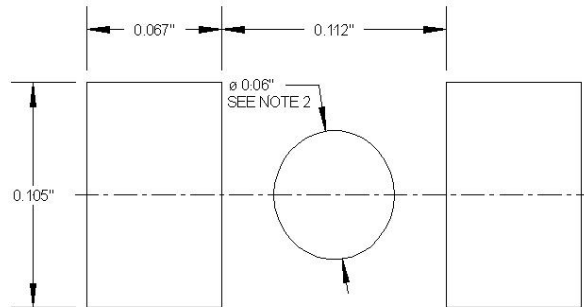
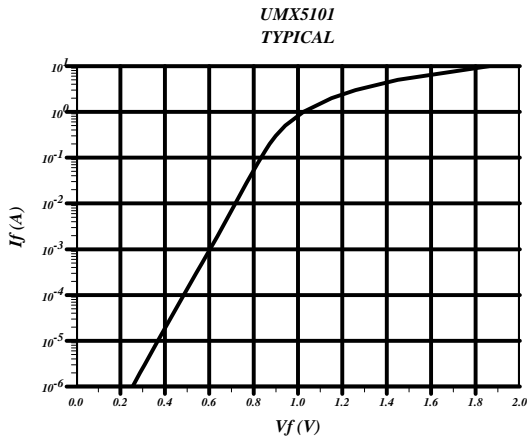
**C-V CURVES**

**RP - PARALLEL RESISTANCE**

**RS VS IF**

**VF VS IF**
**SM STYLE SOLDER FOOTPRINT**

**A SIZE  
(STANDARD SMALL  
SQUARE END CAP OUTLINE)**

**NOTES:**

1. These dimensions will match the terminals and provide for additional solder fillets at the outboard ends at least as wide as the terminals themselves, assuming accuracy of device placement within .005 inches.
2. If the mounting method chosen requires use of an adhesive separate from the solder compound, a round (or square) spot of cement as shown should be centrally located.

Dimensions shown are in inches

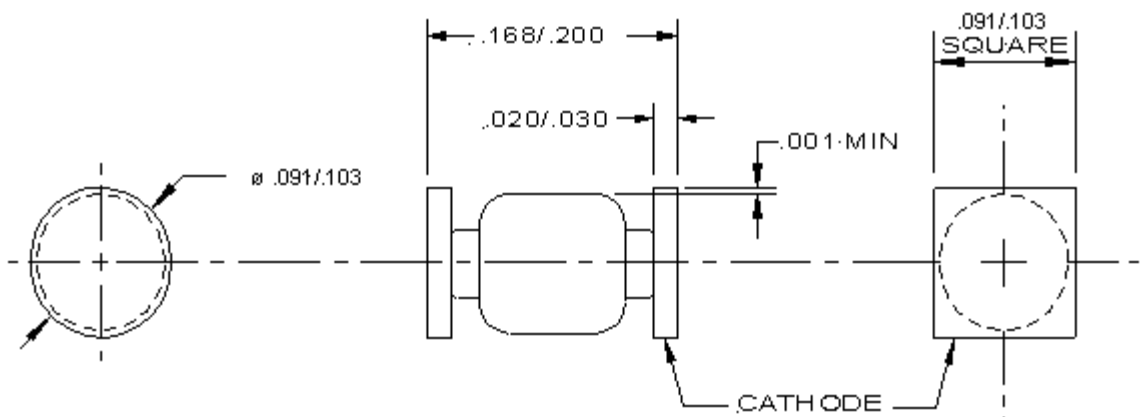
**"SM" STYLE PACKAGE OUTLINE**

**DIMENSIONS SHOWN ARE IN INCHES**