

6W LMT3811 20.8:1 Transformer
DESCRIPTION

This document describes and specifies the electrical and mechanical characteristics of the SGE2660-3G high voltage transformer for CCFL inverter power supplies. SGE2660-3G is the RoHS compliant and Lead free transformer. For Reliability and Safety Specification, refer to SGE2606-2.

ELECTRICAL CHARACTERISTICS

Items	Inductance (@ 10KHz, 0.1V)			Items	DC. Resistance		
	Min	Nom	Max		Min	Nom	Max
L1-2, L2-3 (μH)	420	476	544	R _{DC} 1-2, R _{DC} 2-3(mΩ)	545	557	572
L4-5 (mH)	690	777	920	R _{DC} 4-5 (Ω)	348	364	380
L _{LKG1-2} , L _{LKG2-3} (μH)	Inductance (@ 100KHz, 1V)			R _{DC} 1-2 / R _{DC} 2-3	0.96	1	1.04
	50	52	54				
L _{LKG4-5} (mH)	NA	NA	NA	Secondary Self Capacitance (HP4192A 1MHz C meter, 30mVrms)			
				C _{4.5} (pF)	2.0	2.5	3.0
Rating				Dielectric Voltage Withstand			
Note: Max output power varies depend on operating condition.				60Hz, Arc-detect enabled, 5 sec. min. 200μA max. leakage current			
Max Open Output Voltage	2000V _{RMS} , 3sec.			Secondary to Core	2500V _{RMS} min. (60sec)		
Max Output Voltage	1100V _{RMS}			Primary to Core	1000V _{RMS} min.		
Max Output Power	6W			Primary to Secondary	2500V _{RMS} min.		

WINDING SPECIFICATIONS

	Primary		Secondary
	Pin 1 – 2	Pin 2 – 3	Pin 4 – 5
Winding Sequence	2S – 1F	3S – 2F	5S – 4F
Wire Size & Type	#34, Single Insulation, 180°C	#34, Single Insulation, 180°C	#46, Triple Insulation, 180°C
Number of Turns	36	36	1500
Winding Method	Bifilar		Skip sector 1. (Empty)

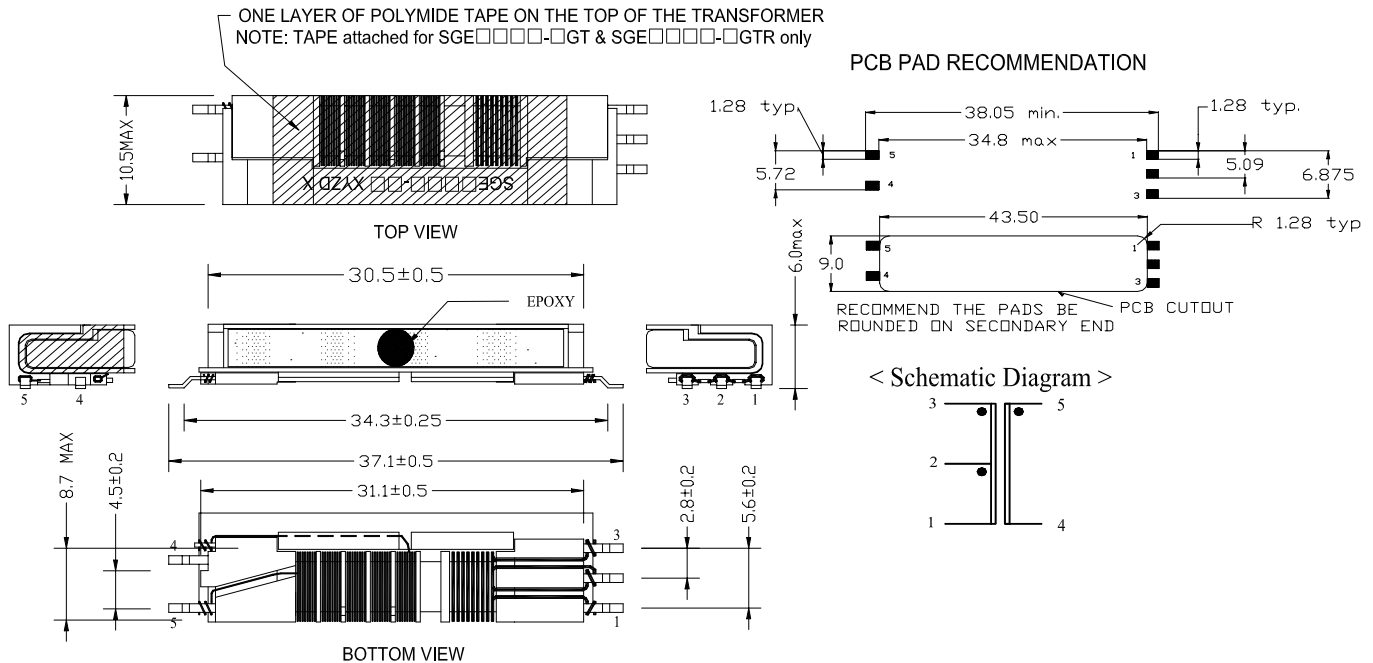
PHYSICAL SPECIFICATIONS & WIRING DIAGRAM

PART MARKING

SGE□□□□-□G XYZD A – SGE2660-3G: MSC PN, XYZ: Datecode (X:YR, YZ=WK), D: Plant Code, A: Rev.#

PACKAGING SPEC AND ORDER INFORMATION

Packaging Order Information – SGE2660-3G (Standard for TRAY)
 SGE2660-3GTR (Tape and Reel)
 SGE2660-3GT (with Polyimide Tape for TRAY)

TAPE & REEL : Refer to SGE2604-4 specification



Microsemi[®]

Specification Number
SGE2660-3G
Revision. A (082905)

6W LMT3811 20.8:1 Transformer

NOTES

PRODUCTION DATA – Information contained in this document is proprietary to Microsemi and is current as of publication date. This document may not be modified in any way without the express written consent of Microsemi. Product processing does not necessarily include testing of all parameters. Microsemi reserves the right to change the configuration and performance of the product and to discontinue product at any time.