

# MicroSolutions

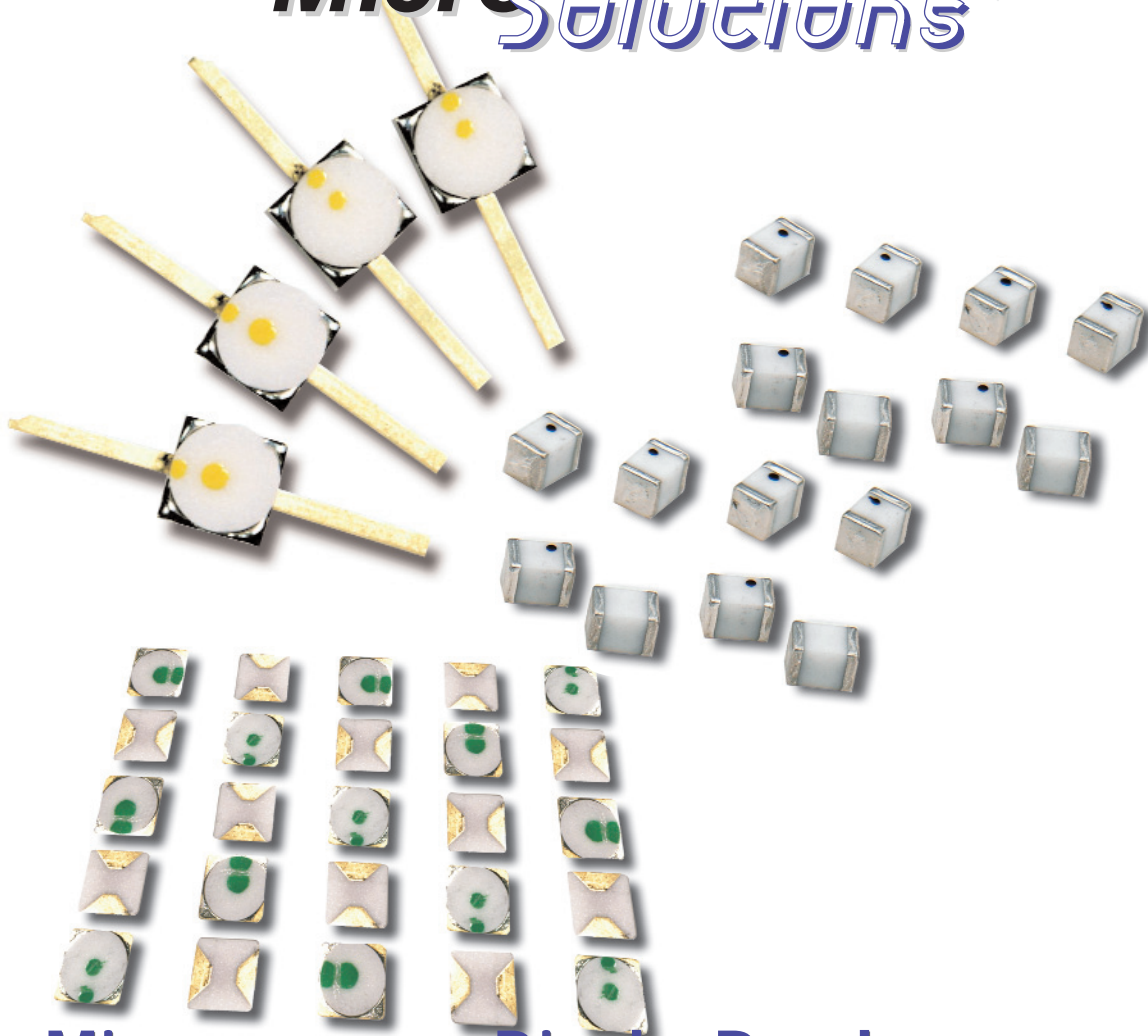

## Microwave Diode Packages: Know what you are getting!

By K. R. Philpot  
Director of Applications, Microsemi-Lowell



more than solutions - enabling possibilities

**T**here is no subject that causes more problems and confusion for users of microwave diodes than the effects of the diode package. Packages always limit the performance of the circuit design, sometimes in unexpected ways. This paper will discuss the different types of packages available, the attributes of each, and the effects one might expect when used in some common circuit applications.

Packages are a necessary evil. In a perfect world, all designs would make use of the unpackaged die, installed eutectically and wire bonded into the circuit. But microwave diode packages afford protection for the die, ease of handling, and a means of efficient automated circuit assembly. Any discussion of microwave diode packages must start with an understanding of the detrimental attributes that packages bring.

## Parasitics

Parasitics are unwanted electrical and mechanical attributes. They always serve to limit circuit performance. Package types have various combinations of different parasitics. The right choice of packages is always a compromise of some sort. Often it is the lesser of several evils. Let's examine the different microwave diode package parasitics:

**Series Inductance (Lp):** Because any diode package has exterior terminations that must be connected to the die inside there will always be an inductance value associated with the wire or conductor used to accomplish this. The best high frequency microwave packages will have values as low as 150 pH. The worst can have over 2000 pH. This is like putting a large value of inductive reactance in the worst possible place in your circuit: directly in series with the diode!

**Shunt Capacitance (Cp):** All solid materials have dielectric constants associated with them. And because all packages are constructed of these materials they behave like a capacitor. Values vary from under 100 fF to over 1000 fF. And this capacitor is also in the worst possible place in your circuit: Directly across the terminals of the diode!

**Series Resistance (Rs):** The conductors used to connect the die to the exterior of the package are usually gold wire or at least gold plated. and although gold is a very good conductor, the magnitudes of resistance that can affect microwave circuit performance is very tiny. A 0.1 Ohm value of resistor in series with the device can result in measurable reduction in switch isolation or an increase in VCO phase noise.

**Thermal Resistance ( $\theta_J$ )** Devices such as PIN diodes or SRDs need to have a thermal shunt to ground in order to dissipate power in the form of heat. Otherwise the device will be destroyed by excess junction temperature. Some packages are designed to have excellent thermal properties with thermal resistance values as low as 10 degrees C / W. Others have values as high as hundreds of degrees C / W.



# Circuit implications of package parasitics

As a general rule PIN diode switch applications demand the lowest possible parasitic capacitance. This value directly limits the isolation that can be achieved in a series design. Additionally low values of thermal resistance are also highly desirable in order not to compromise the power handling characteristics of the device.

PIN diode limiters also require packages which have low thermal resistance but it is also imperative to limit parasitic inductance.

Schottky diodes used as mixers or detectors usually do not have to dissipate power, so package thermal resistance is not usually a concern. Parasitic inductance and capacitance are important to minimize but not critical as in PIN diode applications.

Varactor diodes used in Voltage controlled oscillators (VCOs) demand the very lowest package parasitic inductance. This value will directly affect the maximum frequency which can be achieved. Package parasitic capacitance will limit the bandwidth and tuning linearity of the VCO. Because VCOs do not require power to be dissipated in the varactor, package thermal resistance is usually not important.

Comb generators and harmonic generators using SRDs (step recovery diodes) and VGVs (harmonic generator varactors) demand the lowest possible package thermal resistance due to the large power dissipations these applications require. Package parasitic inductance and capacitance can often be tuned out provided the magnitude is not too great.

## Package categories

In general terms, packages can be grouped broadly into 3 categories: **Microwave**, **Surface Mount**, and **Through Hole**. Some package types such as Microwave Monolithic Surface Mount (MMSM™) belong in more than one category. Let's discuss each category and look at some examples. Refer to Table 1 for some comparisons between package types.

Package Type	Lp	Cp	Rs	P	Cost	Max Frequency (GHz)	Hermetic	Comments
<b>Ceramic</b>	Excellent	Excellent	Excellent	Excellent	High	18	Yes	All products available
<b>MELF</b>	Good	Fair	Excellent	Very Good	Moderate	2	Yes	Only select PIN diodes available
<b>MMSM</b>	Very Good	Very Good	Good	Very Good	Low	8	No	Only select PINs and varactors
<b>EPSM</b>	Good	Good	Good	Good	Moderate	6	No	All products available
<b>Glass Axial</b>	Fair	Good	Good	Poor	Moderate	1.5	Yes	Many products available
<b>Plastic</b>	Poor	Fair	Fair	Poor	Low	2	No	Only select PINs, varactors, and Schottkys
<b>Stripline</b>	Good	Good	Good	Fair	Moderate	8	Yes or No	All products available

Table 1

# Microwave

There are 3 package types which can be used at microwave frequencies above 6 GHz.

**Ceramic packages** are the best performing microwave package styles available. They are hermetic and the type of choice for military and space applications. They are also the most expensive. They combine low parasitic inductance, low parasitic capacitance and can have superior thermal resistance characteristics as well. Most products are available in ceramic packages. Outline 30 and 79 are good examples (Figures 1 & 2)

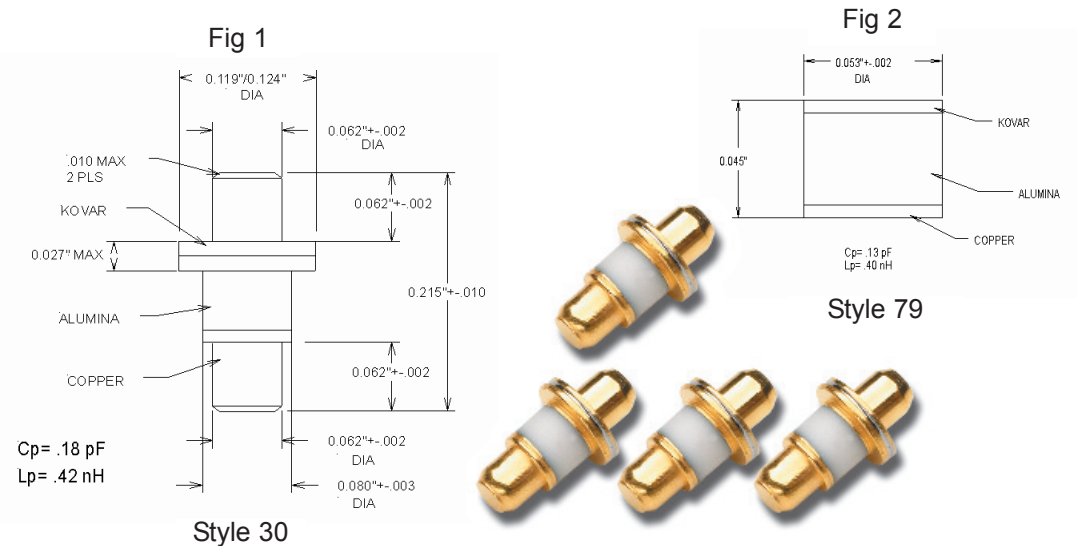

**MMSM™** packages combine the attributes of excellent microwave performance, surface mount convenience, and economy pricing. But only select products are available in this outline. Consult the factory for details. Figure 3 shows the MMSM package outline (206).

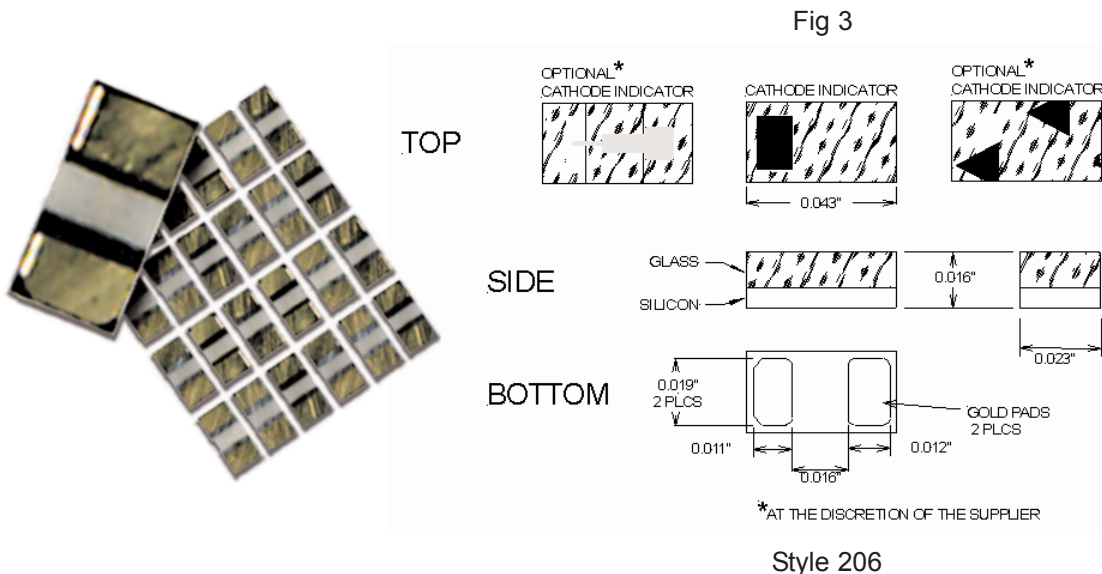

**Stripline packages** for microwave are usually also ceramic and can be completely hermetic or have epoxy encapsulation. They combine low parasitic inductance, low parasitic capacitance and are designed specifically for stripline or microstrip construction. They can however have high thermal resistance and are not the best choice for applications which will result in high device dissipation. Style 17 (Figure 4) is hermetic, style 127A (Figure 5) is epoxy encapsulated

Fig 4

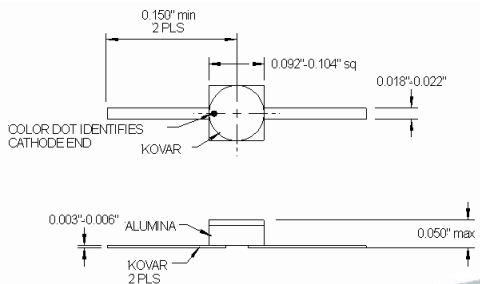

Style 17

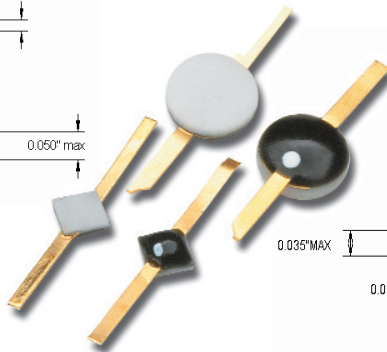
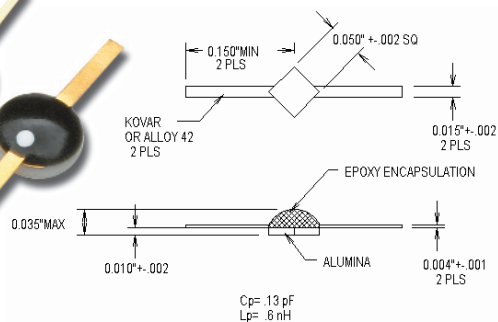

Fig 5



Style 127A

## Surface Mount

There are 6 types that can be used for surface mount applications. Once again some fall into more than one category: **MMSM**, **Ceramic**, **EPSM**, **MELF**, and **Plastic (SOT-23)**.

**MMSM** outline 206 was discussed under microwave packages above.

**Ceramic surface mount** packages combine all the excellent attributes of ceramic microwave packages with the ease of surface mount assembly compatibility. Most products are available in this type. Figure 6 shows a good example / outline 149.

Fig 6

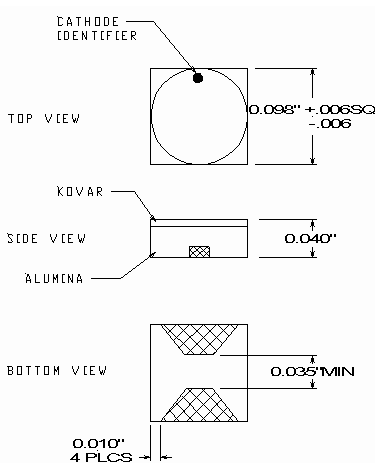

Style 149



**Enhanced Performance Surface Mount (EPSM™)** packages offer solid consistent performance for applications up to 6 GHz. Both parasitic inductance and parasitic capacitance are very low compared to conventional plastic injection molded surface mount packages. Thermal resistance is moderate but superior to plastic as well. Additionally there are a wide range of outlines from which to choose. And most products we offer are available in EPSM. Figures 7, 8, and 9 show some common EPSM outlines.

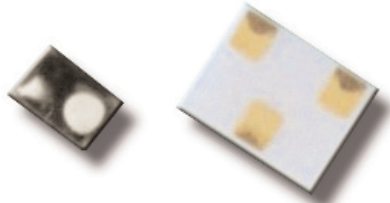

Fig 7

Fig 8

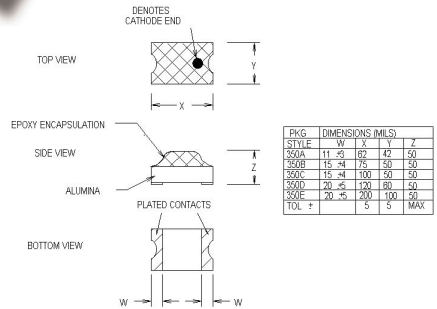
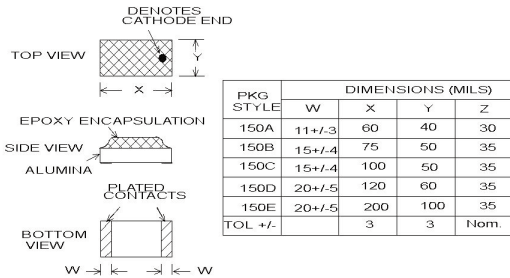
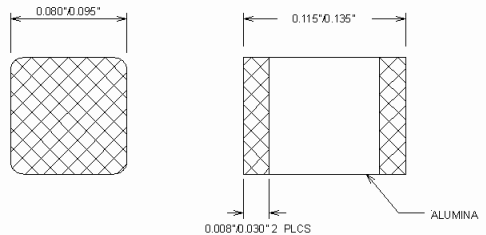
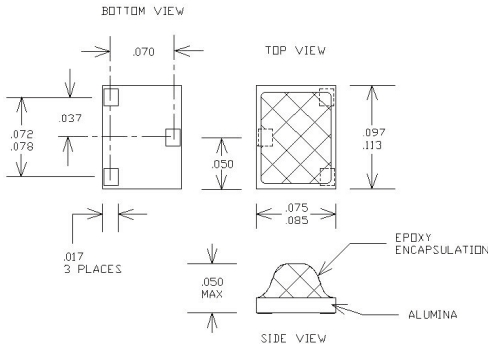

Fig 9

Fig 10



Style M1



**Metal Electrode Leadless Faced (MELF)** packages are specially designed for PIN diodes. They have low values of parasitic inductance but high values of parasitic capacitance. They are suitable for frequencies under 2 GHz and have very low thermal resistance, making them also suitable for power applications. Only select PIN diodes are available in MELF packages. Consult the factory for details. Figure 10 shows the M1 MELF style.

**Plastic SOT-23** packaged devices are rugged economical packages suitable for low power applications with frequencies up to 2 GHz. They have moderately high levels of all parasitics but are ideal for less critical higher volume commercial use Figure 11 shows the SOT-23 style package.

Fig 11

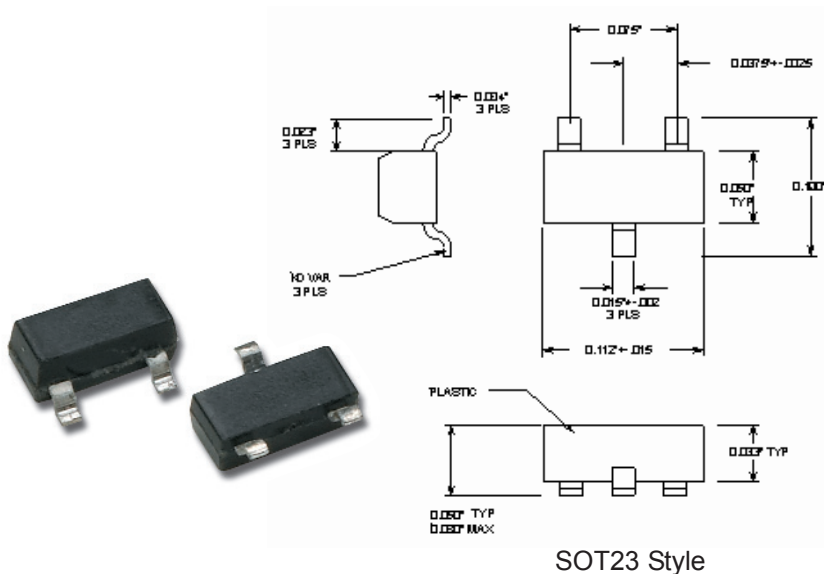

## Thru Hole

**Glass axial** packaged diodes have been around for many years and are still popular today for UHF frequencies and below. Their hermeticity and proven environmental design are favorites for military requirements. They have very high thermal resistance which makes them unsuitable for high power applications. Figure 12 & 13 show 2 common glass axial package styles.

Fig 12

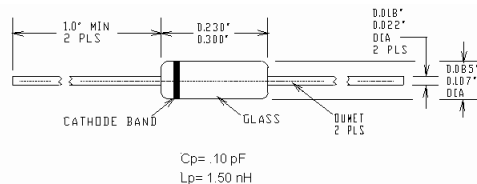

Style 11

Fig 13

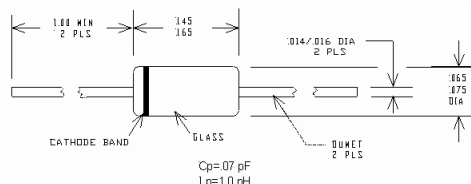

Style 15

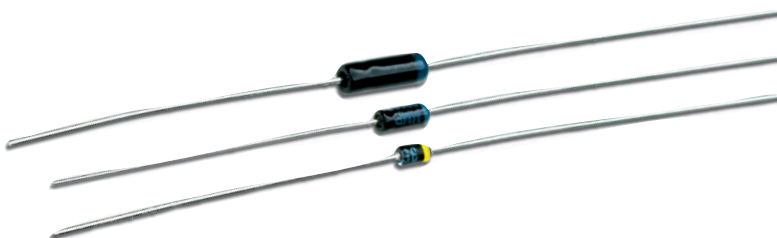

### **Need help choosing?**

Our applications engineering department is always available to discuss your requirement and help you choose the optimum device and package to suit your technical and budgetary needs.

Contact Ken Philpot direct at (978) 442-5616  
or e mail: [kphilpot@microsemi.com](mailto:kphilpot@microsemi.com)



more than solutions - enabling possibilities

***Microsemi Lowell***  
175 Technology Drive  
Lowell, MA 01851  
USA

Phone: (978) 442-5600  
Fax: (978) 937-3748

**[www.microsemi.com](http://www.microsemi.com)**